

A top-down view of a swimmer in a pool. The swimmer is in the center, performing a freestyle stroke with arms extended. The pool is divided into lanes by dark lane lines and red-and-white floating lane markers. Large white chevrons are positioned at the top and bottom of the frame. The background is a clear, light blue sky.

AQUASPHERE

BUYERS GUIDE FALL WINTER 2022

This document features non-contractual pictures



SWIM GOGGLES

ADULT

VISTA PRO	16
VISTA	18
VISTA XP	20
KAYENNE PRO	22
KAYENNE	24
KAYENNE COMPACT	26
KAIMAN EXO	28
XCEED	30
NINJA	32
FASTLANE	34
SEAL 2.0	36
EAGLE	37
KAIMAN	38
KAIMAN COMPACT	40
MAKO	42

KIDS

VISTA JUNIOR	44
SEAL KID	46
KAYENNE JUNIOR	48
MOBY KID	50

WETSUITS

PHANTOM V3	57
RACER V3	58
PURSUIT V3	59
LIMITLESS	60
AQUASKIN	62
STINGRAY	66
SIZE CHARTS	68

SWIMWEAR

MATRIX	72
ESSENTIALS	78
SIZE CHARTS	87

TRAINING EQUIPMENT & ACCESSORIES

ALL ACCESSORIES	88
-----------------	----

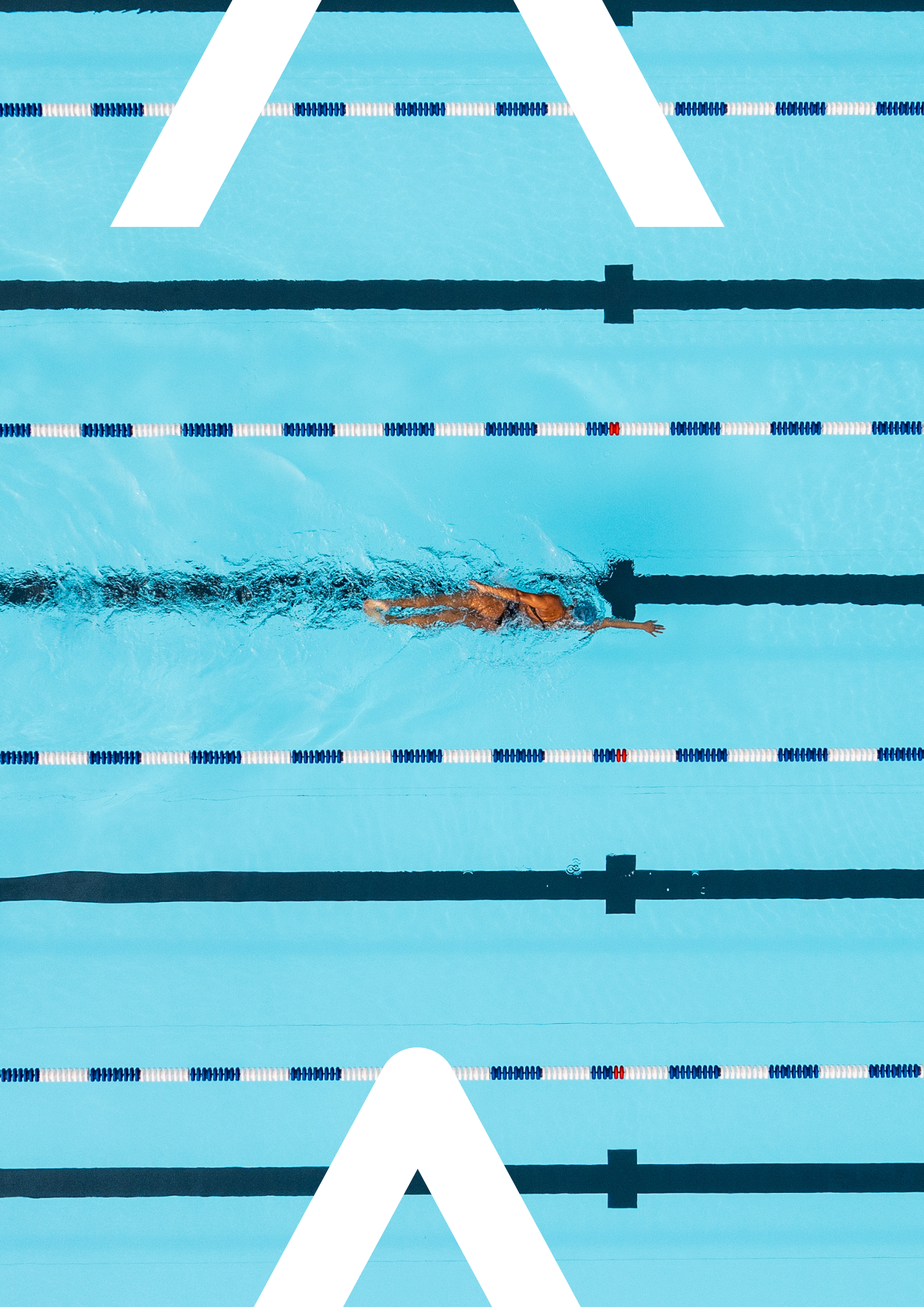

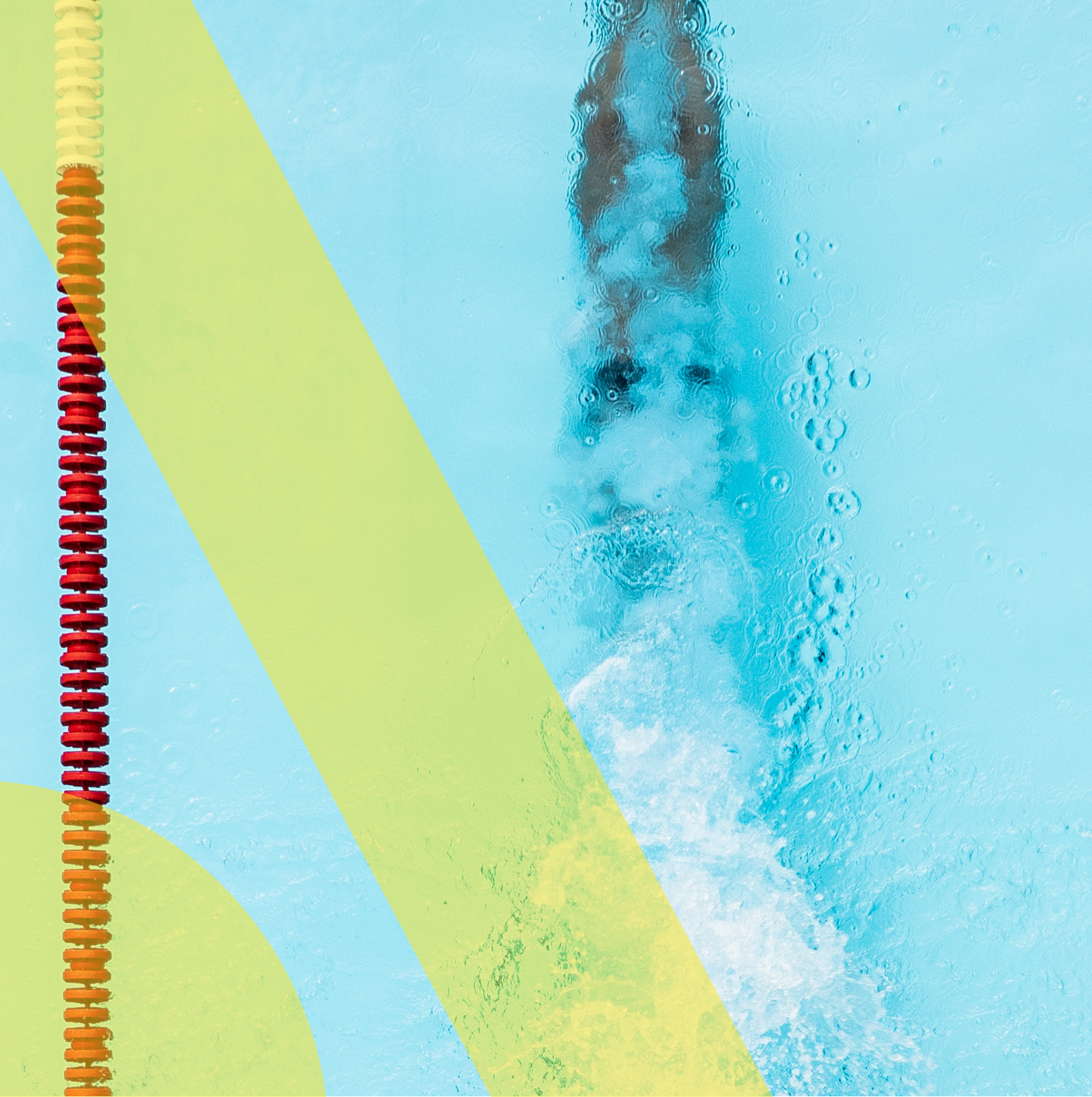

**YOUR PLAYGROUND.
YOUR CHALLENGES.
BE LIMITLESS.**



It's **not just swimming.**

It's about **breaking** *your personal barriers* and reaching **new horizons.**

It's about **embracing** *your individuality* while sharing your **PASSION.**

It's the **right** to be **real**, to be **BOLD.**

BORN IN 1998

Inspired by years of working in the scuba diving industry, it took the Italian engineers, P. Ferraro and G. Beltrani, two years of experimenting, testing and prototyping to finally patent the first curved lens with no visibility distortion: the Seal swim mask.

FROM CREATIVE *INGENUITY TO PERFORMANCE*

Sharpened over more than 30 years of research, Aquaphere's craftsmanship excellence is based on purposefully advanced and patented technologies, high-quality materials and driven by our swimming community.

AUTHENTIC *PASSION*

Whatever the playground, we gear the free-spirited swimmer and celebrate each individual in their pursuit of achievement.

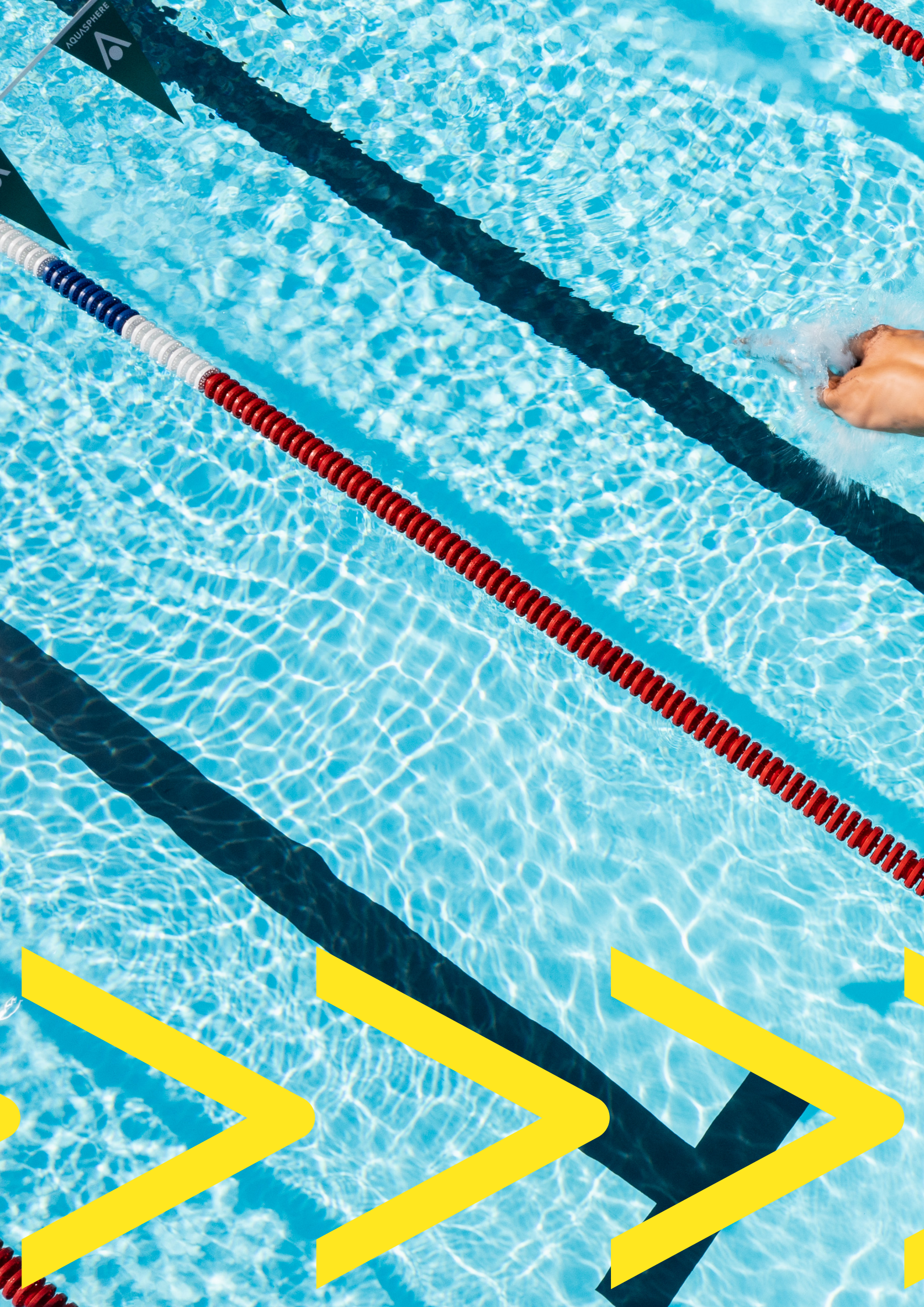

AQUASPHERE

A
K
A





PULL BUOY - 93p

XCEED - 30p

NEW THIS SEASON

LIGHTNING WAVE



FOCUS SNORKEL - 90p

NINJA - 32p

ESSENTIALS TIE BACK - 82p



SWIM GOGGLES

CHALLENGE *DRIVEN*

Our passion for purposeful driven and innovative swim eyewear, keeps inspiring us to elevate our products to enhance our swimmers experience.

MADE IN *ITALY*

Through our in-house R&D Department and manufacturing facilities based in Italy, we design and craft swim eyewear that combine performance, reliability and comfort.

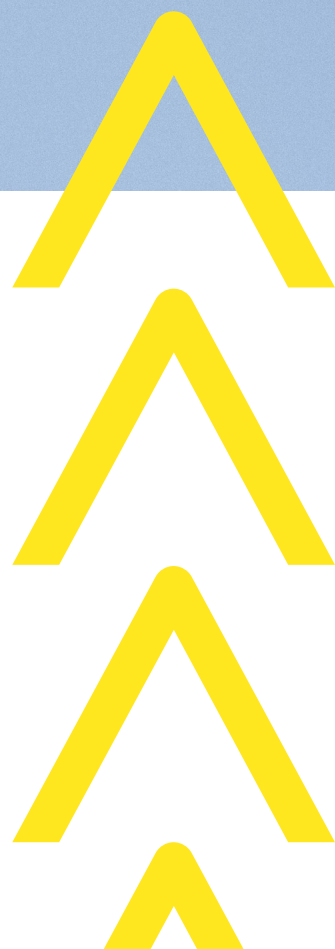

A LENS FOR EVERY CONDITION

A lens solution for all environments for unrivaled vision from low to very bright light condition.

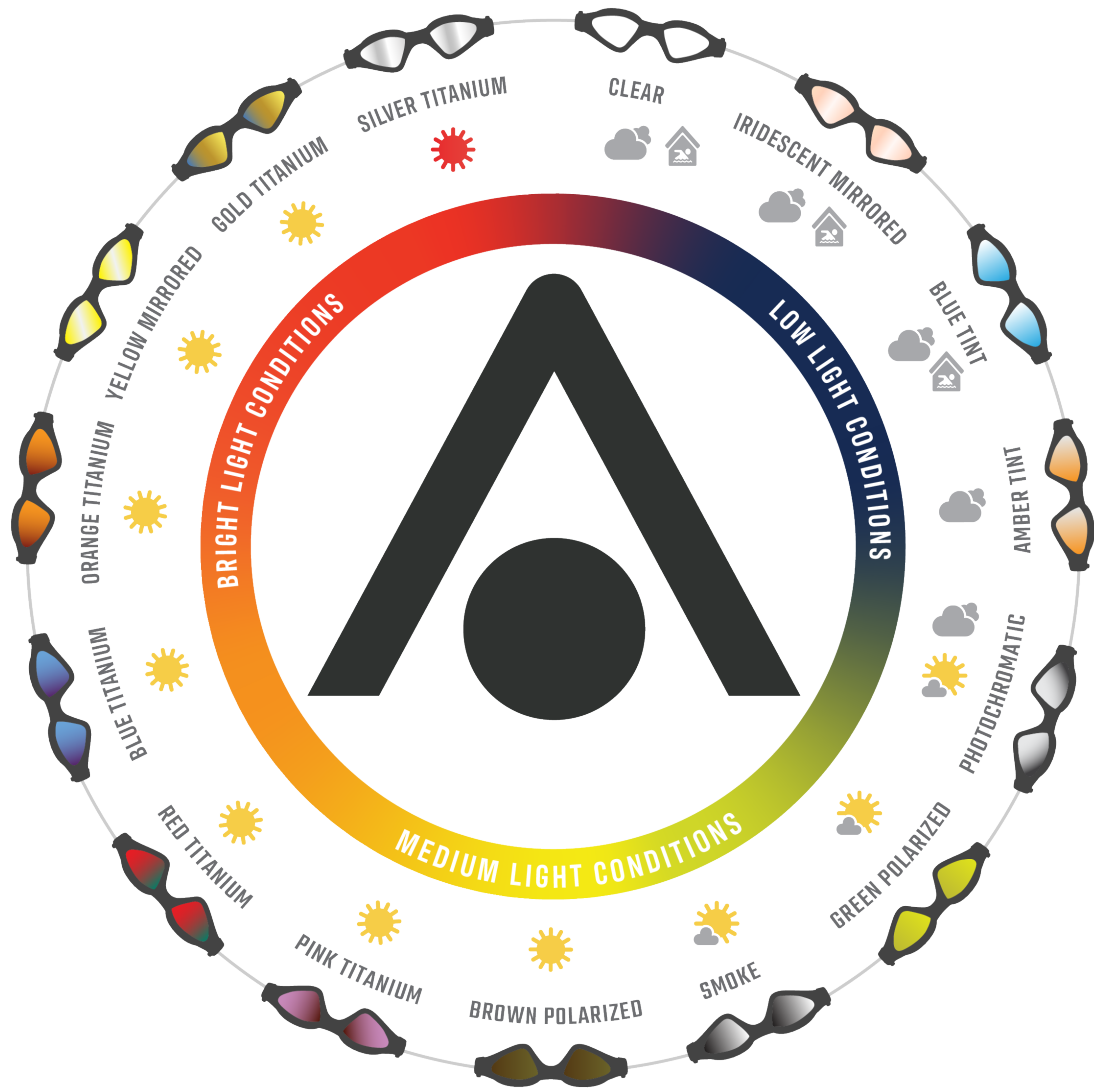

INDOOR		CLOUDY / OVERCAST		PARTLY SUNNY W/ CLOUDS		SUNNY		VERY BRIGHT	
--------	--	-------------------	--	------------------------	--	-------	--	-------------	--

LENS TECHNOLOGY

A full assortment of performance-engineered lenses in a wide range of tints to enhance our swimmers experience.

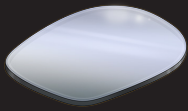

SILVER TITANIUM MIRRORED

- Maximum Light Protection
- Boosts Color Contrast
- Infra red cut

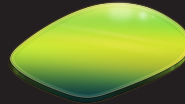

GREEN POLARIZED

- Decreased light transmission
- Reduced glare
- Blue light cut



GOLD TITANIUM MIRRORED

- Maximum Light Protection
- Boosts Color Contrast
- Reduced glare

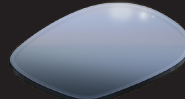

SMOKE

- Decreased light transmission
- Maintains color saturation
- Increases natural contrast



YELLOW TITANIUM MIRRORED

- Maximum Light Protection
- Boosts Color Contrast
- Reduced glare

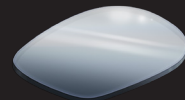

PHOTOCHROMATIC

- Adapts to all conditions
- Changes with level of UV
- Increased light protection



ORANGE TITANIUM MIRRORED

- Maximum Light Protection
- Boosts Color Contrast
- Reduced glare



AMBER TINTED

- Increased contrast
- Reduced glare
- Enhanced vision

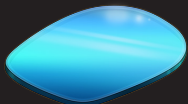

BLUE TITANIUM MIRRORED

- Maximum Light Protection
- Boosts Color Contrast
- Enhances warm color against blue

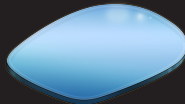

BLUE TINTED

- Increased contrast
- Reduced glare



RED TITANIUM MIRRORED

- Maximum Light Protection
- Boosts Color Contrast
- Infra red cut



NEW



IRIDESCENT MIRRORED

- Maximizes visibility
- Decreased light transmission



PINK TITANIUM MIRRORED

- Maximum Light Protection
- Boosts Color Contrast
- Increases contrast against blue water

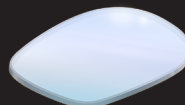

CLEAR

- Transmits natural light
- Maximizes visibility



BROWN POLARIZED

- Decreased light transmission
- Reduced glare
- Enhances sharpness



LENS FEATURES

CURVED LENS



Premium optics engineering based on 3 key placed radii, virtually eliminating distortion while delivering an uninterrupted 180° wide field of vision with exceptional hydrodynamics.

180° DISTORTION FREE VISION

ANTI-FOG



Durable anti-fog properties, whether it's coated (polycarbonate lenses) or embedded (plexisol lenses), guarantee best visibility. For additional protection, check out our eco-friendly anti-fog solution Sea-Clr Antifog spray.

LIGHT PROTECTION



Embedded within the lens's material (polycarbonate and plexisol), the properties of our lenses protect your eyes from harmful rays.

FRAME FEATURES



INTERCHANGEABLE NOSE BRIDGE

Customizable fit for swimmers to find a nose bridge that matches their face width and eye position. For a perfect comfortable fit and leak free seal.

AVAILABLE FOR: KAYENNE PRO, XCEED, NINJA, FASTLANE.



AFT: ADVANCED FIT TECHNOLOGY

A technology with dual texture and density that provides softer grip to the face reducing marks on skin and offers watertight seal for maximum comfort.

AVAILABLE FOR: VISTA PRO, KAIENNE PRO, NINJA, KAIMAN EXO, SEAL 2.0



EXO-CORE

The bi-material frame technology combines exceptional stability with maximum comfort. The semi-rigid exoskeleton allows lens protection and integrated structure, while ultra soft Softeril material offers a streamlined, lightweight design with enhanced durability.

AVAILABLE FOR: XCEED, NINJA, KAIMAN EXO.



QUICK FIT

Easy push button that makes tightening and loosening quick and simple, even while wearing. The micro-metric strap adjustment buckle streamlines the goggle and improves precision and comfort.

AVAILABLE FOR: VISTA PRO, KAYENNE PRO, KAYENNE, VISTA, VISTA JUNIOR



E-Z ADJUST

Low profile strap allows for precise adjustment. Simply pull the straps back to your desired level of tension for a leak free fit or lift the buckle tabs and pull the goggle forward to loosen.

AVAILABLE FOR: KAIMAN EXO, KAIMAN, SEAL 2.0, KAYENNE JUNIOR, MAKO, EAGLE, MOBY KID, SEAL KID



PIVOTING BUCKLE

Adjusts and rotates to the shape of the head for a perfect and comfortable fit.

AVAILABLE FOR: VISTA PRO



STABLE STRAP

New patented Strap Management System enables the two straps to stay in uniform formation offering quick hassle-free adjustments and provides greater level of stability during dives and turns.

AVAILABLE FOR: FASTLANE



RACE FIT SYSTEM

Customizable and low-profile strap adjustment system paired with a high-quality silicone strap.

AVAILABLE FOR: NINJA

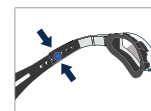

VISTA PRO

PERFORMANCE

>>> Designed with the Open Water Adventure Swimmer in mind, the Vista Pro offers our greatest field of vision through its curved single lens. Utilising latest technologies, we have incorporated Advanced Fit Technology (AFT) into our silicone skirt to offer best fit and comfort for a wide range of faces. The new buckle system integrates a new pivoting technology providing two important benefits: structural stability and fit.



PIVOT BUCKLE STRAP SYSTEM

adjusts to the shape of your head



AFT: ADVANCED FIT TECHNOLOGY

provides a leak resistant seal



SILICONE SKIRT

for comfort and a better fit



SINGLE LENS

Provides 180° distortion free vision



LATEX FREE

>>> OTHER FEATURES:

- quick fit buckle
- antiscratch
- hypoallergenic



MS5041201LMO

Orange Titanium Mirrored
VISTA PRO.A DGY BLK LMO



MS5040644LMR

Red Titanium Mirrored
VISTA PRO.A RED DKB LMR



MS5040007LMS

Silver Titanium Mirrored
VISTA PRO.A CL/YLW LMS



MS5040007LD

Smoke
VISTA PRO.A CL/YLW LD



NEW

MS5040001LMI

Iridescent Mirrored
VISTA PRO.A TRANSP BLK LMI



MS5041201LC

Clear
VISTA PRO.A DGY BLK LC

VISTA

ACTIVE

>>> Popular with Open Water Swimmers ready for a challenge, the Vista is a durable silicone mask made for unpredictable environments. Vista's low profile virtually eliminates all of the drag experienced with other swimming masks. With it's soft silicone skirt, and one touch buckle, you are ensured a comfortable, custom fit so you can focus on your swim, not your gear.



QUICK FIT BUCKLE

provides perfect fit & easy adjustments



COMFORTABLE SILICONE SKIRT

assures leak resistant seal



>>> OTHER FEATURES:

- distortion free vision
- antiscratch
- hypoallergenic



CURVED LENS GEOMETRY

for 180° wide peripheral vision



MS5050915LMR
Red Titanium Mirrored
 VISTA.A WHITE RED LMR



MS5050010LMB
Blue Titanium Mirrored
 VISTA.A TRP GRY LMB



MS5051201LMS
Silver Titanium Mirrored
 VISTA.A DGY BLK LMS



MS5050915LD
Smoke
 VISTA.A WHITE RED LD



MS5050916LD
Smoke
 VISTA.A WHITE RASPBERRY LD



MS5050012LD
Smoke
 VISTA.A TRP DGY LD

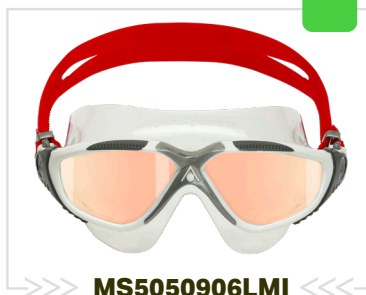

MS5050906LMI
Iridescent Mirrored
 VISTA.A WHT RED LMI

NEW



MS5050915LC
Clear
 VISTA.A WHITE RED LC

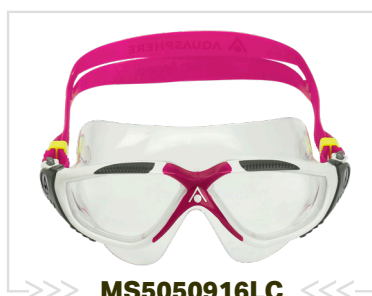

MS5050916LC
Clear
 VISTA.A WHITE RASPBERRY LC



MS5050012LC
Clear
 VISTA.A TRP DGY LC



MS5054340LC
Clear
 VISTA.A TBL BLU LC

VISTA XP

ACTIVE

>>> The Vista XP swimming mask is a call for adventure to all swimmers tempted by the experience of open water swimming or training for their first triathlon. This single Plexisol lens mask with its soft skirt offers broad distortion-free vision while being quick to put on thanks to its Quick Fit buckle. Even if your goal is about your well-being and fitness, a simple but high-quality mask is where to start the adventure confidently.



SINGLE LENS
provides 180° distortion free vision



ULTRA SOFT SOFTERIL SKIRT
for maximum comfort



MS5090001LD

Smoke

VISTA X.P.A. TRANSP BLACK LD



MS5094009LC

Clear

VISTA X.P.A. BLUE WHITE LC



MS5090006LC

Clear

VISTA X.P.A. TRANSPARENT RED LC



>>> **OTHER FEATURES:**

- antiscratch
- hypoallergenic



KAYENNE PRO

PERFORMANCE

>>> The Kayenne Pro is the perfect fit for the Triathlete featuring, increased field of vision for spotting landmarks and buoys during your swim. Utilising latest technologies, we have incorporated Advanced Fit Technology (AFT) into the softer skirt to offer best fit and comfort. The wide gasket allows for greater stability during high contact starts.



ADJUSTABLE NOSE BRIDGE
with 4 interchangeable size options for a perfect fit



AFT: ADVANCED FIT TECHNOLOGY
provides a leak resistant seal



QUICKFIT BUCKLE
provides perfect fit & easy adjustments



CURVED LENS GEOMETRY
for 180° wide peripheral vision



>>> OTHER FEATURES:

- oversized plexisol lens: increase upper visibility
- wide gasket: improve stability
- antiscratch
- hypoallergenic



EP3040910LP

Brown Polarized

KAYENNE PRO.A WHT GRY LPB



EP3040707LMY

Yellow Titanium Mirrored

KAYENNE PRO.A YLW YLW LMY



EP3040910LMR

Red Titanium Mirrored

KAYENNE PRO.A WHT GRY LMR



EP3040910LPH

Photochromatic

KAYENNE PRO.A WHT GRY LPH



EP3040010LMS

Silver Titanium Mirrored

KAYENNE PRO.A TRASP/GRY LMS



EP3040010LD

Smoke

KAYENNE PRO.A TRASP/GRY LD



EP3040707LD

Smoke

KAYENNE PRO.A YLW YLW LD



EP3040010LMI

Iridescent Mirrored

KAYENNE PRO.A TRANSP GRY LMI



EP3040010LC

Clear

KAYENNE PRO.A TRASP/GRY LC



EP3040707LC

Clear

KAYENNE PRO.A YLW YLW LC

KAYENNE

ACTIVE

>>> With its unique, oversized lens design, the Kayenne combines expanded 4-point vision with superior hydrodynamics thanks to its low-profile micro-frame. It also features a stabilising bimaterial nose bridge, for a secure and comfortable fit.

This combination makes the Kayenne a perfect choice whether in a pool or open water.



STABILIZING BIMATERIAL NOSE BRIDGE
provides a secure and comfortable fit



SOFTERIL SKIRT
for comfort and leak resistant seal



QUICK FIT BUCKLE
offers easy onetouch strap adjustments



>>> **OTHER FEATURES:**

- distortion free vision
- antiscratch
- hypoallergenic



EP2960098LP

Brown Polarized

KAYENNE.A TR/SILVER/PETR LPB



EP2961008LPB

Brown Polarized

KAYENNE.A GRY ORG LPB



EP2964409LPV

Green Polarized

KAYENNE.A DKB WHT LPV



EP2961006LMR

Red Titanium Mirrored

KAYENNE.A GREY RED LMR



EP2964409LMB

Blue Titanium Mirrored

KAYENNE.A DKB WHT LMB



EP2960043LMB

Blue Titanium Mirrored

KAYENNE.A TRP TBL LMB



EP2961006LMS

Silver Titanium Mirrored

KAYENNE.A GREY RED LMS



EP2960098LD

Smoke

KAYENNE.A TR/SILVER/PETR LD



EP2961006LD

Smoke

KAYENNE.A GREY RED LD



EP2960115LD

Smoke

KAYENNE.A BLK SLV LD



EP2960015LD

Smoke

KAYENNE.A TRP SLV LD



EP2961006LMI

Iridescent Mirrored

KAYENNE.A GRY RED LMI



EP2960098LC

Clear

KAYENNE.A TR/SILVER/PETR LC



EP2960115LC

Clear

KAYENNE.A BLK SLV LC



EP2960001LC

Clear

KAYENNE.A TRP BLK LC

NEW

KAYENNE COMPACT

ACTIVE

>>> With its unique, oversized lens design, the Kayenne combines expanded 4-point vision with superior hydrodynamics thanks to its low-profile micro-frame. It also features a stabilising bimaterial nose bridge, for a secure and comfortable fit.

This combination makes the Kayenne a perfect choice whether in a pool or open water.

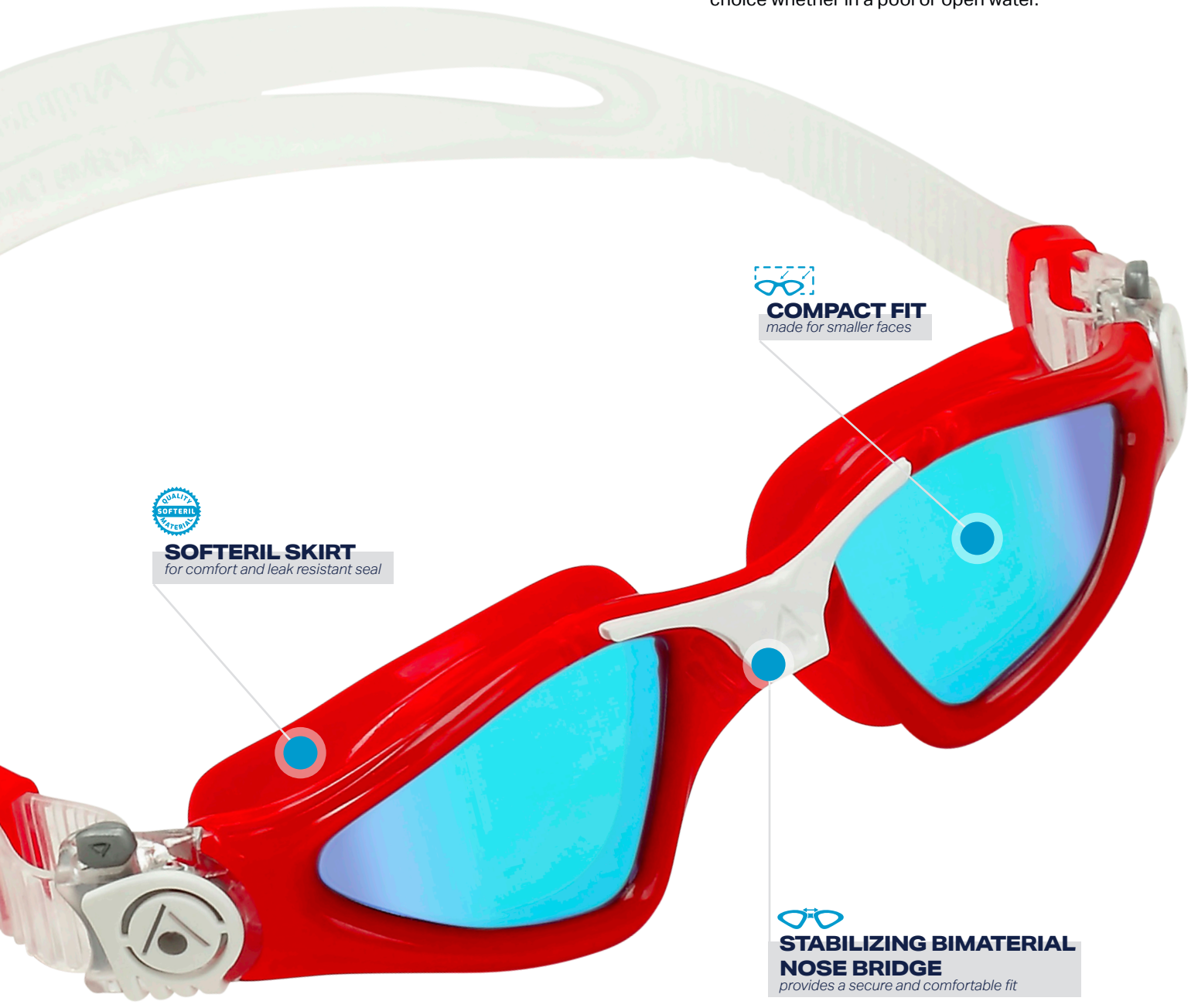

SOFTERIL SKIRT
for comfort and leak resistant seal



COMPACT FIT
made for smaller faces



STABILIZING BIMATERIAL NOSE BRIDGE
provides a secure and comfortable fit



>>> **OTHER FEATURES:**

- distortion free vision
- antiscratch
- hypoallergenic

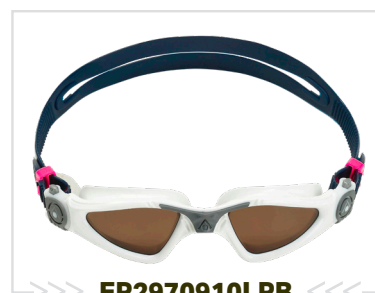

EP2970910LPB

Brown Polarized

KAYENNE SMALL.A WHT GRY LPB



EP2970609LMB

Blue Titanium Mirrored

KAYENNE SMALL.A RED WHT LMB



EP2970016LD

Smoke

KAYENNE SMALL.A TRAN/RASP LD



EP2970016LC

Clear

KAYENNE SMALL.A TRAN/RASP LC

KAIMAN EXO

ACTIVE

>>> Building off the long-standing success of our bestselling Kaiman design, which has sold more than eight million units, the Kaiman EXO incorporates first-of-its kind EXO-core bi-material frame technology that combines maximum stability with comfort. The Kaiman EXO is the perfect for the everyday swimmer looking to maximize comfort and durability.



EXO CORE TECHNOLOGY
provides stability and allows for a great fit



EZ ADJUST BUCKLES WITH SILICONE SPLIT STRAP
for quick and easy fit adjustments



>>> **OTHER FEATURES:**

- antiscratch
- hypoallergenic



EP2981000LMB

Blue Titanium Mirrored
KAIMAN EXO.A GRY TRP LMB



EP2980700LMB

Blue Titanium Mirrored
KAIMAN EXO.A YLW TRP LMB



EP2989800LMS

Silver Titanium Mirrored
KAIMAN EXO.A PETR/TRANSP LMS

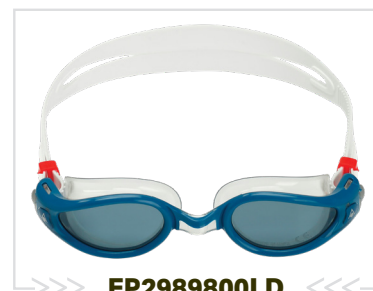

EP2989800LD

Smoke
KAIMAN EXO.A PETR/TRANSP LD



EP2980100LD

Smoke
KAIMAN EXO.A BLK TRP LD



EP2989800LC

Clear
KAIMAN EXO.A PETR/TRANSP LC

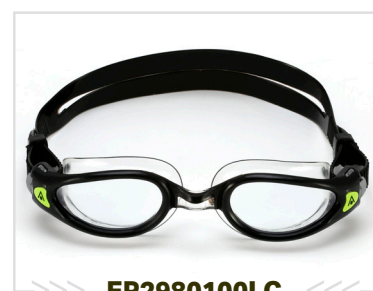

EP2980100LC

Clear
KAIMAN EXO.A BLK TRP LC

XCEED

PERFORMANCE

>>> The XCEED combines patented curved lens technology and a hydrodynamic low profile fit to give swimmers a competitive edge in perfect clarity. Featuring Exo-Core technology, for maximum comfort, durability and flexibility, the XCEED is a popular Racing and Training partner of many competitive swimmers.



ADJUSTABLE NOSE BRIDGE

with 4 interchangeable size options for a perfect fit



EXO CORE TECHNOLOGY

provides stability and great hydrodynamics



CURVED LENS GEOMETRY

for 180° wide peripheral vision



ULTRA SOFT SOFTERIL SKIRT

for maximum comfort



>>> OTHER FEATURES:

- distortion free vision
- antiscratch
- hypoallergenic



EP3037104LMY
Yellow Titanium Mirrored
 XCEED.A BRIGHT YLW NVY LMY



EP3030101LMY
Yellow Titanium Mirrored
 XCEED.A BLK BLK BLK LMY



EP3030404LMB
Blue Titanium Mirrored
 XCEED.A NVY NVY LMB



EP3030101LMR
Red Titanium Mirrored
 XCEED.A BLK BLK BLK LMR



EP3030101LMP
Pink Titanium Mirrored
 XCEED.A BLK BLK BLK LMP



EP3030107LMS
Silver Titanium Mirrored
 XCEED.A BLK BLK YLW LMS



EP3030109LMS
Silver Titanium Mirrored
 XCEED.A BLK BLK WHT LMS



EP3030107LD
Smoke
 XCEED.A BLK BLK YLW LD



EP3030109LD
Smoke
 XCEED.A BLK BLK WHT LD

NINJA

PERFORMANCE

>>> The revolutionary Ninja goggle combines a patented frame technology and a hydrodynamic low profile fit offering giving swimmers a competitive edge with the light weight, streamlined goggle. Utilising latest technologies, we have incorporated Advanced Fit Technology (AFT) into the softer skirt to offer best fit and comfort. The patented Race Fit System offers swimmers a hassle-free experience so they can simply set the strap once and focus on swimming fast.



EXO CORE TECHNOLOGY
for ultimate hydrodynamics



ADJUSTABLE NOSE BRIDGE
with 4 interchangeable size options for a perfect fit



AFT: ADVANCED FIT TECHNOLOGY
provides a leak resistant seal



RACE FIT SYSTEM
for customizable fit



>>> OTHER FEATURES:

- distortion free vision
- antiscratch
- hypoallergenic

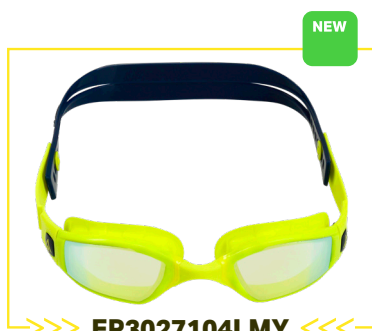

EP3027104LMY

Yellow Titanium Mirrored
NINJA.A BRIGHT YLW NVY LMY



EP3020101LMY

Yellow Titanium Mirrored
NINJA.A BLACK BLACK LMY

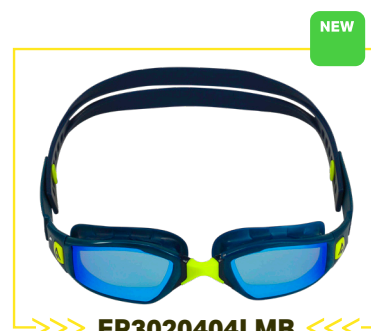

EP3020404LMB

Blue Titanium Mirrored
NINJA.A NVY NVY LMB



EP3020109LMB

Blue Titanium Mirrored
NINJA.A BLACK WHITE LMB



EP3020109LMS

Silver Titanium Mirrored
NINJA.A BLACK WHITE LMS



EP3020109LD

Smoke
NINJA.A BLACK WHITE LD

FASTLANE

ACTIVE

>>> The Fastlane goggle has an asymmetrical, anatomical design, and when paired with the soft silicone skirt offers a natural, comfortable, watertight fit. The patented Strap Management System offers quick hassle-free strap adjustments plus four nose bridge options ensuring a perfect fit. This is a perfect goggle for your everyday training needs.



**ULTRA SOFT SILICONE
INNEREYE GASKET**
assures comfort and leak resistant seal



**PATENTED
STRAP SYSTEM**
offers quick adjustments



**ADJUSTABLE
NOSE BRIDGE**
*with 4 interchangeable size
options for a perfect fit*



>>> **OTHER FEATURES:**

- antiscratch
- hypoallergenic



EP2990907LMY
Yellow Titanium Mirrored
 FASTLANE.A WHITE YELLOW LMY



EP2994009LMB
Blue Titanium Mirrored
 FASTLANE.A BLUE WHITE LMB



EP2990243LMP
Pink Titanium Mirrored
 FASTLANE.A PINK TURQUOISE LMP

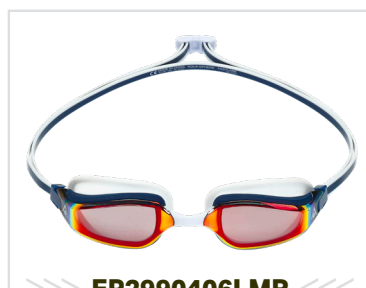

EP2990406LMR
Red Titanium Mirrored
 FASTLANE.A NAVY BLUE RED LMR

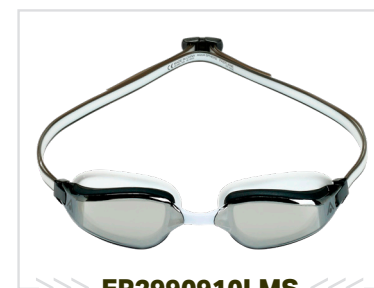

EP2990910LMS
Silver Titanium Mirrored
 FASTLANE.A WHITE GREY LMS

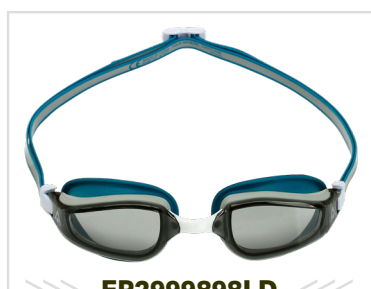

EP2999898LD
Smoke
 FASTLANE.A PETROL PETROL LD



EP2994007LB
Blue Tinted
 FASTLANE.A BLUE YELLOW LB

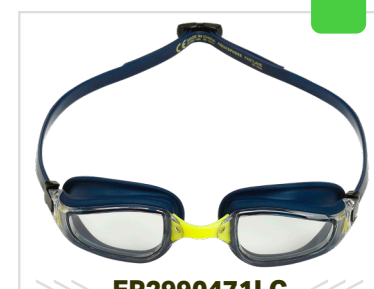

EP2990471LC
Clear
 FASTLANE.A NVY BRIGHT YLW LC

NEW

SEAL 2.0

ACTIVE

>>> The Seal 2.0 is a direct descendant of our original swim mask, the Seal, and is the perfect swim mask for fitness swimmers. With its large format wrap-around lens design, the Seal offers a wide field of vision and the soft silicone facial skirt integrates Aquasphere's Advanced Fit Technology for a comfortable, watertight fit.



AFT: ADVANCED FIT TECHNOLOGY
provides a leak resistant seal



EZ ADJUST BUCKLES WITH SILICONE SPLIT STRAP
for quick and easy fit adjustments



COMFORTABLE SILICONE SKIRT
fits a wide variety of faces for maximum comfort



MS5074109LD

Smoke

SEAL 2.0.A LBL WHT LD



MS5070103LD

Smoke

SEAL 2.0.A BLK GRN LD



MS5074109LC

Clear

SEAL 2.0.A LBL WHT LC



MS5070110LC

Clear

SEAL 2.0.A BLK GRY LC



>>> **OTHER FEATURES:**

- distortion free vision
- antiscratch
- hypoallergenic

EAGLE

ACTIVE

>>> Eagle Prescription Swim Goggles come with polycarbonate interchangeable lenses that you can easily swap out for custom corrective vision. Utilizing a unique construction of a one-piece silicone skirt and nose bridge frame combined with interchangeable lens retainer allows swimmers to purchase right and left high grade optical lenses to meet their specific vision.



EP3060000LC

Clear

EAGLE.A TRP TRP LC



EP3064400LC

Clear

EAGLE.A DBL TRP LC

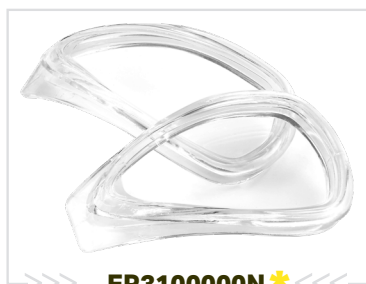

EP3100000N*

Clear

OPTICAL LENS T EAGLE



SILICONE SKIRT
for comfort and leak resistant seal



EZ ADJUST BUCKLES WITH SILICONE SPLIT STRAP
for quick and easy fit adjustments

>>> Lenses come in half-step increments from -1.5 to -6.0 to match individual strengths for each eye.

Sold separately.

-1.5	EP3100000N15
-2.0	EP3100000N20
-2.5	EP3100000N25
-3.0	EP3100000N30
-3.5	EP3100000N35
-4.0	EP3100000N40
-4.5	EP3100000N45
-5.0	EP3100000N50
-5.5	EP3100000N55
-6.0	EP3100000N60



>>> **OTHER FEATURES:**

- antiscratch
- hypoallergenic

KAIMAN

ACTIVE

>>> Our original first curved lens goggle, bringing 180-degree vision to active swimmers. The Kaiman was designed with comfort and fit in mind, featuring our proprietary Softeril material and easy adjust side buckles.



EZ ADJUST BUCKLES WITH SILICONE SPLIT STRAP
for quick and easy fit adjustments



ULTRA SOFT SOFTERIL SKIRT
for maximum comfort



>>> **OTHER FEATURES:**

- antiscratch
- hypoallergenic



EP3000098LMS
Silver Titanium Mirrored
 KAIMAN.A CLEAR PETROL LMS



EP3000101LMS
Silver Titanium Mirrored
 KAIMAN.A BLK BLK LMS



EP3000098LD
Smoke
 KAIMAN.A CLEAR PETROL LD



EP3000000LD
Smoke
 KAIMAN.A TRP TRP LD



EP3000101LD
Smoke
 KAIMAN.A BLK BLK LD



EP3000000LB
Blue Tinted
 KAIMAN.A TRP TRP LB



EP3000101LA
Amber Tinted
 KAIMAN.A BLK BLK LA



EP3000098LC
Clear
 KAIMAN.A CLEAR PETROL LC



EP3000000LC
Clear
 KAIMAN.A TRP TRP LC



EP3000101LC
Clear
 KAIMAN.A BLK BLK LC



EP3004100LC
Clear
 KAIMAN.A LBL TRP LC

KAIMAN COMPACT

ACTIVE

>>> Our original first curved lens goggle, bringing 180-degree vision to active swimmers. The Kaiman was designed with comfort and fit in mind, featuring our proprietary Softeril material and easy adjust side buckles.



ULTRA SOFT SOFTERIL SKIRT
for maximum comfort



COMPACT FIT
made for smaller faces



EZ ADJUST BUCKLES WITH SILICONE SPLIT STRAP
for quick and easy fit adjustments



>>> **OTHER FEATURES:**

- antiscratch
- hypoallergenic



EP3070101LD

Smoke

KAIMAN SMALL.A BLK BLK LD



EP3070000LD

Smoke

KAIMAN SMALL.A TRP TRP LD



EP3070000LB

Blue Tinted

KAIMAN SMALL.A TRP TRP LB

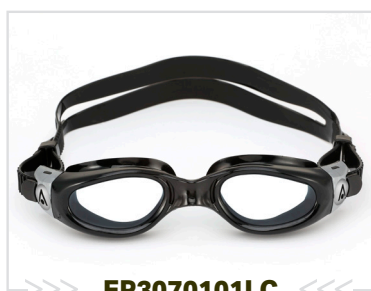

EP3070101LC

Clear

KAIMAN SMALL.A BLK BLK LC



EP3070043LC

Clear

KAIMAN SMALL.A TRP TBL LC



EP3070000LC

Clear

KAIMAN SMALL.A TRP TRP LC

MAKO

ACTIVE

>>> Bringing Aquasphere's comfort and quality to the everyday swimmer, the Mako utilizes a one-piece frame construction and easy-to-adjust side buckles. The Mako is a perfect goggle for the casual swimmer who's looking for a comfortable solution.



**ULTRA SOFT
SOFTERIL SKIRT**
allows maximum comfort & leak
resistant seal



**EZ ADJUST BUCKLES WITH
SILICONE SPLIT STRAP**
for quick and easy fit adjustments



>>> **OTHER FEATURES:**

- flat lens
- antiscratch
- hypoallergenic



EP3080101LD

smoke

MAKO2.A BLK BLK LD



EP3080001LD

Smoke

MAKO2.A TRP BLK LD



EP3080040LB

Blue Tinted

MAKO2.A TRP BLU LB



EP3080101LC

Clear

MAKO2.A BLK BLK LC



EP3080040LC

Clear

MAKO2.A TRP BLU LC



VISTA Junior

JUNIOR

>>> Designed for aged 6+. The Vista Jr fits like a mask by sealing around the outside of the eyes, eliminating any pressure on the eye sockets. This creates a more Comfortable, Leak Free Fit so your kids can wear them all day without worrying about getting water in their eyes.

Incorporating our curved lens technology to offer a wide field of vision to give a very open, unrestricted feel that will boost your kids confidence in the water. Our Quick-Fit Buckle System makes adjusting the Vista Jr head strap easy.



FIT
ages 6+

QUICK FIT BUCKLE
provides perfect fit & easy adjustments

ULTRA SOFT SOFTERIL SKIRT
allows maximum comfort & leak resistant seal



>>> **OTHER FEATURES:**

- antiscratch
- hypoallergenic



MS5080209LB

Blue Tinted

VISTA JR.A PK WHT LB



MS5080031LB

Blue Tinted

VISTA JR.A TRP BGN LB



MS5084008LC

Clear

VISTA JR.A BLU ORG LC



MS5084307LC

Clear

VISTA JR.A TBL YLW LC



MS5080309LC

Clear

VISTA JR.A GRN WHT LC



MS5080040LC

Clear

VISTA JR.A TRP BLU LC



MS5080002LC

Clear

VISTA JR.A TRP PK LC

SEAL KID 2

JUNIOR

>>> The evolution of the original swim mask for children, the Seal Kid 2 delivers a leak-free fit for children as young as 3 years old. The Seal Kid 2 utilizes Aquasphere curved lenses technology for a wide field of vision, making children more confident in the water. The easy-adjust side buckles are simple for kids or parents to adjust even while wearing!



ULTRA SOFT SOFTERIL SKIRT
allows maximum comfort & leak resistant seal

FIT
ages 3+



>>> **OTHER FEATURES:**

- torsion-free inserts
- antiscratch
- hypoallergenic



MS5064009LB

Blue Tinted

SEAL KID2 '18.A BLU WHT LB



MS5060000LB

Blue Tinted

SEAL KID2 '18.A TRP TRP LB



MS5064002LC

Clear

SEAL KID2 '18.A BLUE PINK LC



MS5064340LC

Clear

SEAL KID2 '18.A TURQ BLUE LC



MS5063131LC

Clear

SEAL KID2 '18.A BGN BGN LC



MS5064343LC

Clear

SEAL KID2 '18.A TBL TBL LC



MS5060505LC

Clear

SEAL KID2 '18.A PRP PRP LC



MS5060202LC

Clear

SEAL KID2 '18.A PK PK LC

KAYENNE Junior

JUNIOR

>>> Designed for ages 6-15. The Kayenne Jnr has unique oversized lens design and softeril skirt to combine for a comfortable leak free fit. Quick fit buckles make for easy one touch strap adjustments, even when wearing them!



>>> **OTHER FEATURES:**

- antiscratch
- hypoallergenic



EP3014009LD

Smoke

KAYENNE JR.A BLU WHITE LD



EP3010043LB

Blue Tinted

KAYENNE JR.A TRANSP AQUA LB



EP3014007LC

Clear

KAYENNE JR.A BLU YELLOW LC



EP3014302LC

Clear

KAYENNE JR.A AQUA PINK LC



EP3010131LC

Clear

KAYENNE JR.A BLK BGN LC



EP3010209LC

Clear

KAYENNE JR.A PK WHT LC

MOBY KID

JUNIOR

>>> Bringing Aquasphere comfort and quality to the beginning swimmer, the Moby Kid utilizes a one-piece frame construction, Aquasphere proprietary Softeril material, and easy to adjust side buckles.



ULTRA SOFT SOFTERIL SKIRT
allows maximum comfort & leak resistant seal

FIT
ages 3+



EZ ADJUST BUCKLES WITH SILICONE SPLIT STRAP
for quick and easy fit adjustments



>>> **OTHER FEATURES:**

- flat lens
- antiscratch
- hypoallergenic



EP3090031LB

Blue Tinted

MOBY KID.A CLR BGN LB

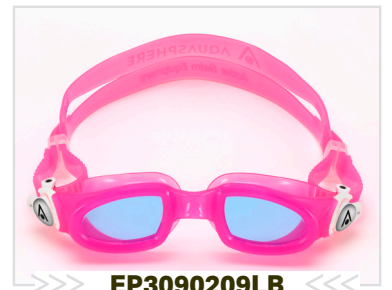

EP3090209LB

Blue Tinted

MOBY KID.A PK WHT LB



EP3094008LC

Clear

MOBY KID.A BLU ORG LC



EP3094331LC

Clear

MOBY KID.A TBL BGN LC

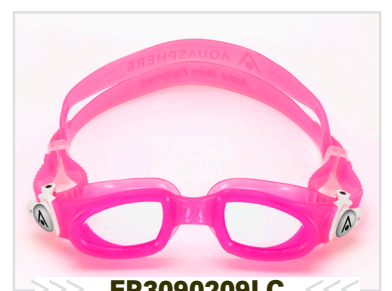

EP3090209LC

Clear

MOBY KID.A PK WHT LC

WETSUITS

PURPOSEFULLY
ADVANCED
TECHNOLOGY

Innovative mix of **performance** and **long-lasting comfort**, we aim to provide triathletes and open water swimmers the **best training and race wetsuits.**





COMMON FEATURES TO ALL OUR **WETSUITS**

YAMAMOTO NEOPRENE

Widely recognized as the most durable, lightest, ultra flexible and warmest available, all Aquasphere wetsuits are made using Yamamoto neoprene.

Its exceptional performance characteristics and uniform cell structure assures high heat insulation, low water absorption and ultimate flexibility.

YAMAMOTO 40, 39 & 38 WITH SCS COATING

BIO STRETCH ZONES



Aquasphere wetsuits fit and acts like a second skin providing maximum range of motion.

THERMO GUARD



Technology allowing to keep your body at warmth temperature.

QUICK DRYING



Fast drying material given by the SCS coating (Super Composite Skin).

TRIATHLON

CORE POWER



Internal adjustable belt provides extra support to the back improving the posture and enhancing hip rotation and lengthens stroke.

AVAILABLE FOR: PHANTOM V3

ULTIMATE BUOYANCY

Strategically placed panels allow staying in horizontal position then spending less energy. This additional buoyancy results in less drag maximizing performance.

AERODOME PANELS AVAILABLE FOR: PHANTOM V3, AQUA SKIN SHORT V2, AQUA DRIVE PANELS AVAILABLE FOR: PHANTOM V3, RACER V3, PURSUIT V3

AQUA FLEX COLLAR



Watertight seal with maximum comfort through its double layer, ultra-fine design which minimizes neck chaffing.

AVAILABLE FOR: PHANTOM V3, RACER V3, PURSUIT V3

QUICK RELEASE PANELS

Strategical placed panels on cuff and ankle allow quick and easy release.

AVAILABLE FOR: PHANTOM V3, RACER V3, PURSUIT V3

YKK ZIPPER WITH LEASH



Extended length, YKK zipper with leash for easy on/off and quick transitions.

OPEN WATER

BLIND STICHED



Assembled by glue and blind stitches to avoid the water to go through your suit.

AVAILABLE FOR: LIMITLESS SUITS V2, ALL AQUASKIN



Phantom V3

PERFORMANCE

>>> The enhanced Phantom provides an increased range of motion with strategically placed 1.5mm Yamamoto 40 panels and reinforced waist panels for posture support. The Phantom provides warmth, flexibility, comfort and speed. This is our most technological wetsuit designed for the most elite athletes.



YAMAMOTO 40 & BIO STRETCH ZONES

Maximize range of motion 1,5mm panels under arms and lower back, 1mm panels on arm, shoulder and collar

AERODOME TECHNOLOGY

Maximizes buoyancy and reduces drag

QUICK RELEASE PANELS

At the back for easy release for better transition time



- 1mm C40
- BIO STRETCH 1.5mm C40
- 2mm C40
- 1.5mm C39
- 3.5mm C39
- 4mm C39
- 5mm AERODOME
- 5mm C38
- FABRIC + 3D PRINT

OTHER FEATURES

- Yamamoto 40: super stretch, SCS-Coated for ultimate comfort & flexibility
- 5mm neoprene panels: maximizes buoyancy and reduces drag
- Core Power system: extra support improving posture and enhancing hip rotation
- Thermo-Guard technology: on chest, shoulders and legs to maintain body heat
- Reverse-pull zipper: with leash for easy on/off and quick transitions
- Double layer collar: maximizes comfort and prevents chaffing



MEN

SU8370175
BLACK / GOLD

2XS/XS/S/M/ML/L/XL/2XL



WOMEN

SU8320175
BLACK / GOLD

2XS/XS/S/M/L/XL

Racer V3



Thanks to improved ergonomic cutting and strategically placed 1.5 mm Yamamoto 40 panels, the Racer provides the best fit for comfort, warmth and speed. Designed to maximize buoyancy, reduce drag and maintain streamlined body position, the Racer is the optimal wetsuit.



DOUBLE LAYER COLLAR
Maximizes comfort and prevents chaffing

YAMAMOTO 39 AND 40 & BIO STRETCH ZONES
Maximize range of motion

QUICK RELEASE PANELS
At the back for easy release for better transition time

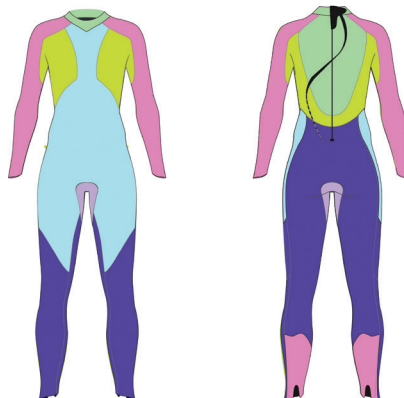

- 1mm C39
- BIO STRETCH 1.5mm C40
- 2mm C39
- 3mm C39
- 3.5mm C49
- 4mm C39
- 5mm C38

OTHER FEATURES

- Yamamoto 39 & 40 super stretch, SCS-Coated:
 - 5mm neoprene panels: maximizes buoyancy and reduces drag
 - 4mm neoprene panels: streamlined body position
- Bio stretch zones: - 1,5mm panels under arms and lower back
- Thermo-Guard technology: on chest, shoulders and legs to maintain body heat
- Back zipper: easy removal



MEN

>>> **SU8390131** <<<

BLACK / RED

2XS/XS/S/M/ML/L/XL/2XL



WOMEN

>>> **SU8340131** <<<

BLACK / RED

2XS/XS/S/M/L/XL

Pursuit V3

>>> The Pursuit gives you durability and comfort with super stretch, SCS-Coated Yamamoto 38 neoprene and improved panel shapes. The Bio-Stretch Zone provides maximum flexibility and reach right where you need it. Be confident during your race.



DOUBLE LAYER COLLAR

Maximizes comfort and prevents chaffing

YAMAMOTO 38 & BIO STRETCH ZONES

Maximize range of motion

QUICK RELEASE PANELS

At the back for easy release for better transition time

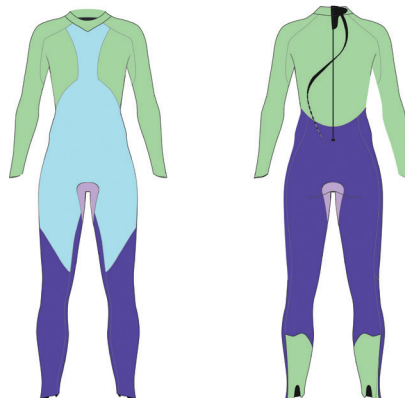

OTHER FEATURES

- Yamamoto 38 super stretch SCS-Coated:
 - 4mm neoprene panels: maximizes buoyancy and reduces drag
- Bio stretch zones:
 - 1,5mm panels at the back
- Thermo-Guard technology: on chest, shoulders and legs to maintain body heat.
- Back zippers: easy removal

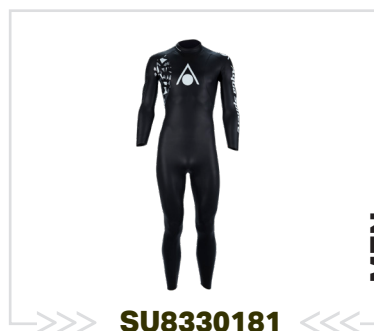

SU8330181

BLACK

2XS/XS/S/M/ML/L/XL/2XL

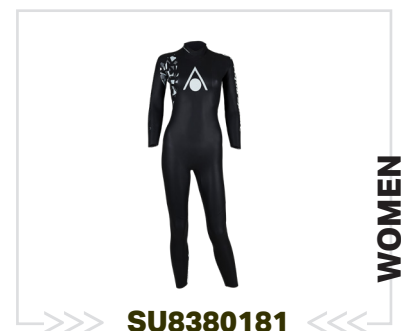

SU8380181

BLACK

2XS/XS/S/M/L/XL

Limitless

PERFORMANCE



The Limitless Swim & Run Shorty is your perfect swimrun partner. Ready for race day, the superstretch neoprene assists you to performance at the highest level. Equipped with 5mm panels on thighs for increased buoyancy, two zippers on the front and back for easy removal, inside pockets for snacks makes this a must have.



FRONT & BACK ZIPPER
Easy removal

STRATEGICALLY PLACED POCKETS
2 front ones and 1 back zipper one

BACK THIGH PANEL
Printed to protect and prevent from tear

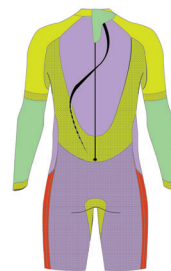

- 1.5mm
- 2mm
- 3mm
- 3.5mm C39

OTHER FEATURES

- Yamamoto 38
3mm neoprene panels on the front thigh: maximize range of motion and additional buoyancy
- Thermo-Guard technology: on chest, shoulders and legs to maintain body heat
- SIDE THIGH PANELS : in 3.5mm for additional buoyancy



»»» SU8290131 «««
BLACK & BRIGHT GREEN
XS/S/M/L/XL/2XL

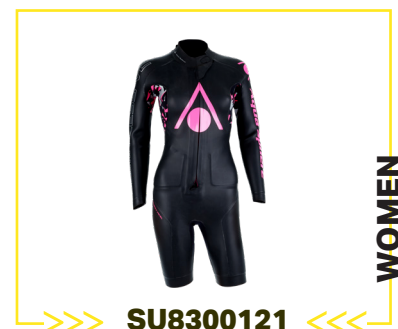

»»» SU8300121 «««
BLACK & BRIGHT PINK
XS/S/M/L/XL

MEN

WOMEN



Aqua Skin Full Suit V3



>>> The Aqua Skin Full Suit and Shorty use 1,5mm Glideskin neoprene to increase speed, flexibility and range of motion in the shoulders, legs and chest; reducing drag coefficient for fast swimming. Designed to take the chill out of your swim, the Thermo-Guard technology not only provides warmth, but also a watertight seal with glued and blindstitched panels.



NEOPRENE 1,5mm
Maximizes comfort and flexibility

THERMO-GUARD TECHNOLOGY
Maintain body heat

OTHER FEATURES

- Glued and blindstitched assembling: keep water out
- Inside wrist
- Pull back zipper: easy on and off
- Armpits in superstretch fabric to optimize movements
- Printed inside wrist and ankle to limit water entries

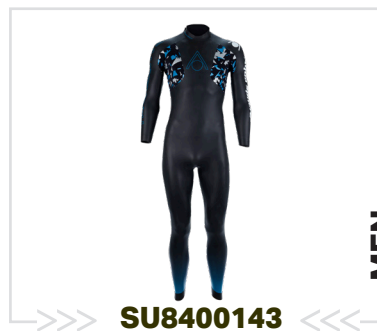

MEN

SU8400143

BLACK TURQUOISE

S/M/L/XL/2XL

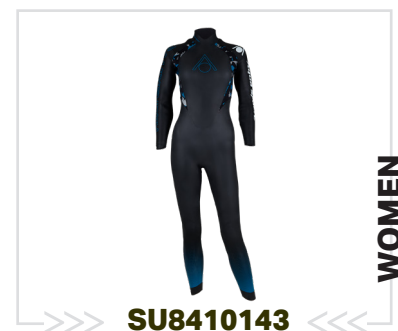

WOMEN

SU8410143

BLACK TURQUOISE

XS/S/M/L/XL

Aqua Skin Shorty V3

>>> The Aqua Skin Full Suit and Shorty use 1,5mm Glideskin neoprene to increase speed, flexibility and range of motion in the shoulders, legs and chest; reducing drag coefficient for fast swimming. Designed to take the chill out of your swim, the Thermo-Guard technology not only provides warmth, but also a watertight seal with glued and blindstitched panels.



NEOPRENE 1,5mm
Maximizes comfort and flexibility

THERMO-GUARD TECHNOLOGY
Maintain body heat

OTHER FEATURES

- Glued and blindstitched assembling: keep water out
- Inside wrist
- Pull back zipper: easy on and off
- Printed inside wrist to limit water entries



SU8520143
BLACK TURQUOISE
S/M/L/XL/2XL

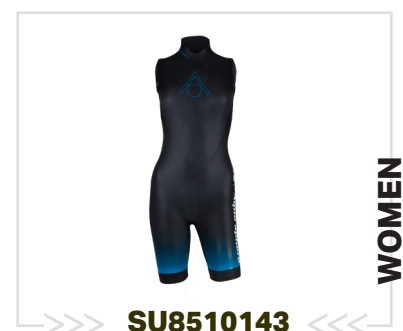

SU8510143
BLACK TURQUOISE
XS/S/M/L/XL

Aqua Skin Top V3

>>> The Aqua Skin Top is ultra-light, durable and offers high range of motion thanks to its ultra thin neoprene panels combined with Polyester spandex sleeves.



HYBRID CONSTRUCTION

0,5mm Neoprene on body and fabric on sleeve: protect and maintain heat

THERMO-GUARD TECHNOLOGY

Maintain body heat



MEN

SU8430143

BLACK TURQUOISE

S/M/L/XL/2XL



WOMEN

SU8440143

BLACK TURQUOISE

XS/S/M/L/XL

Aqua Skin Short V2



ADJUSTABLE WAIST BAND
With flat lace: better fitting

AERODOME TECHNOLOGY
5mm neoprene: maximizes buoyancy and reduces drag

NEOPRENE 3mm
Maximizes comfort and flexibility

>>> Designed to take the chill out of your swim, the Aqua Skin Shorts uses super stretch, 3mm Glideskin neoprene to increase speed and freedom of movement in the water by reducing drag coefficient.



Aqua Skin Hood V2



THERMO-GUARD TECHNOLOGY
Maintain body heat

NEOPRENE 2mm
Maximize comfort

The Aqua Skin Hood takes the chill out of your swim with Thermo-Guard technology.

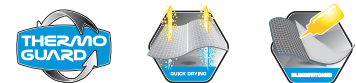

OTHER FEATURES

- Glued and blindstitched assembling

Stingray

JUNIOR



>>> The Stingray HP2 core warmer will keep kids warm, protect them from the sun and allow the freedom of movement they need while playing in and out of the water.

HYBRID CONSTRUCTION
Neoprene and fabric (80% Nylon, 20% Spandex) panels



>>> **SJ4354204** <<<<
ROYAL BLUE NAVY BLUE

1/2/4/6/8/10/12



>>> **SJ4350204** <<<<
PINK NAVY BLUE

1/2/4/6/8/10/12



>>> **SJ4353104** <<<<
BRIGHT GREEN NAVY BLUE

1/2/4/6/8/10/12



>>> **SJ4344204** <<<<
ROYAL BLUE NAVY BLUE

1/2/4/6/8/10/12

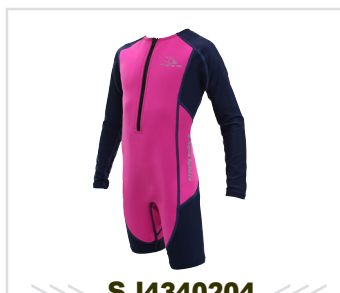

>>> **SJ4340204** <<<<
PINK NAVY BLUE

1/2/4/6/8/10/12

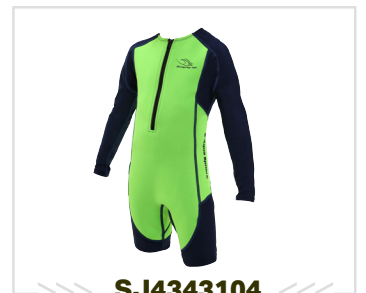

>>> **SJ4343104** <<<<
BRIGHT GREEN NAVY BLUE

1/2/4/6/8/10/12



MEN

PHANTOM V3	WEIGHT (LB/KG)	A - HEIGHT (INCH/CM)	B - CHEST (INCH/CM)	C - WAIST (INCH/CM)	D - HIP (INCH/CM)
2XS	104-121 / 47-55	55-59" / 140-150CM	29-31" / 74-78CM	23-25" / 60-64CM	30-32" / 76-81CM
XS	121-143 / 55-63	59-65" / 150-165CM	31-33" / 78-83CM	25-27" / 64-68CM	31-33" / 78-83CM
S	139-161 / 63-73	65-69" / 165-175CM	32-34" / 82-87CM	27-29" / 68-73CM	32-34" / 81-86CM
M	155-175 / 70-80	68-73" / 173-185CM	34-36" / 86-91CM	28-30" / 72-77CM	33-35" / 84-89CM
ML	165-198 / 75-90	70-75" / 178-190CM	34-37" / 87-93CM	29-31" / 75-80CM	35-37" / 90-95CM
L	187-214 / 85-97	73-76" / 185-195CM	37-39" / 93-99CM	30-32" / 76-82CM	36-38" / 92-97CM
XL	207-242 / 94-110	75-80" / 190-205CM	38-41" / 97-103CM	32-35" / 82-88CM	37-39" / 94-99CM
2XL	242+ / 110+	78+" / 200+CM	40-42" / 101-107CM	34-36" / 86-92CM	38-40" / 96-101CM

RACER V3	WEIGHT (LB/KG)	A - HEIGHT (INCH/CM)	B - CHEST (INCH/CM)	C - WAIST (INCH/CM)	D - HIP (INCH/CM)
2XS	104-121 / 47-55	55-59" / 140-150CM	27-29" / 70-74CM	21-23" / 54-58CM	30-32" / 76-81CM
XS	121-143 / 55-63	59-65" / 150-165CM	29-31" / 74-78CM	23-24" / 58-62CM	31-33" / 78-83CM
S	139-161 / 63-73	65-69" / 165-175CM	31-33" / 78-83CM	24-26" / 62-67CM	32-34" / 80-85CM
M	155-175 / 70-80	68-73" / 173-185CM	32-34" / 82-87CM	25-26" / 66-67CM	34-35" / 85-90CM
ML	165-198 / 75-90	70-75" / 178-190CM	33-36" / 86-91CM	27-29" / 69-74CM	35-37" / 89-94CM
L	187-214 / 85-97	73-76" / 185-195CM	34-37" / 87-93CM	28-30" / 70-76CM	35-37" / 90-95CM
XL	207-242 / 94-110	75-80" / 190-205CM	37-39" / 93-99CM	30-32" / 76-82CM	36-38" / 91-96CM
2XL	242+ / 110+	78+" / 200+CM	38-41" / 97-103CM	32-34" / 80-86CM	37-39" / 93-98CM

PURSUIT V3	WEIGHT (LB/KG)	A - HEIGHT (INCH/CM)	B - CHEST (INCH/CM)	C - WAIST (INCH/CM)	D - HIP (INCH/CM)
2XS	104-121 / 47-55	55-59" / 140-150CM	28-30" / 72-76CM	23-24" / 58-62CM	30-32" / 76-81CM
XS	121-143 / 55-63	59-65" / 150-165CM	30-32" / 76-80CM	24-25" / 62-64CM	31-33" / 78-83CM
S	139-161 / 63-73	65-69" / 165-175CM	32-34" / 80-85CM	26-28" / 66-71CM	32-34" / 80-85CM
M	155-175 / 70-80	68-73" / 173-185CM	33-35" / 84-89CM	27-30" / 70-75CM	34-35" / 85-90CM
ML	165-198 / 75-90	70-75" / 178-190CM	34-37" / 88-93CM	28-30" / 73-78CM	35-37" / 89-94CM
L	187-214 / 85-97	73-76" / 185-195CM	35-37" / 89-95CM	29-31" / 74-80CM	35-37" / 90-95CM
XL	207-242 / 94-110	75-80" / 190-205CM	37-40" / 95-101CM	31-34" / 80-86CM	36-38" / 91-96CM
2XL	242+ / 110+	78+" / 200+CM	39-41" / 99-105CM	33-36" / 84-90CM	37-39" / 93-98CM

LIMITLESS	WEIGHT (LB/KG)	A - HEIGHT (INCH/CM)	B - CHEST (INCH/CM)	C - WAIST (INCH/CM)	D - HIP (INCH/CM)
XS	121-143 / 55-63	59-65" / 150-165CM	29-31" / 74-78CM	23-24" / 58-62CM	31-33" / 78-83CM
S	139-161 / 63-73	65-69" / 165-175CM	31-33" / 78-83CM	24-26" / 62-67CM	32-34" / 80-85CM
M	155-175 / 70-80	68-73" / 173-185CM	32-34" / 82-87CM	25-26" / 66-67CM	34-35" / 85-90CM
L	187-214 / 85-97	73-76" / 185-195CM	34-37" / 87-93CM	28-30" / 70-76CM	35-37" / 90-95CM
XL	207-242 / 94-110	75-80" / 190-205CM	37-39" / 93-99CM	30-32" / 76-82CM	36-38" / 91-96CM
2XL	242+ / 110+	78+" / 200+CM	38-41" / 97-103CM	32-34" / 80-86CM	37-39" / 93-98CM

AQUA SKIN - MEN

SIZE	WEIGHT	HEIGHT
S	136-152 LBS 62-69 KG	63-66 IN 158-168 CM
M	152-167 LBS 69-76 KG	66-69 IN 167-177 CM
L	167-182 LBS 76-83 KG	69-73 IN 176-186 CM
XL	182-198 LBS 83-90 KG	73-76 IN 185-195 CM
XXL	198-213 LBS 90-97 KG	76-80 IN 194-204 CM

AQUA SKIN - WOMEN

SIZE	WEIGHT	HEIGHT
XS	101-123 LBS 46-56 KG	56-60 IN 144-154 CM
S	123-138 LBS 56-63 KG	60-64 IN 153-163 CM
M	138-154 LBS 63-70 KG	64-68 IN 162-172 CM
L	154-169 LBS 70-77 KG	68-71 IN 171-181 CM
XL	169-185 LBS 77-84 KG	71-74 IN 180-190 CM

WOMEN

PHANTOM V3	WEIGHT (LB/KG)	A - HEIGHT (INCH/CM)	B - CHEST (INCH/CM)	C - WAIST (INCH/CM)	D - HIP (INCH/CM)
2XS	104-121 / 47-55	55-59" / 140-150CM	24-26" / 64-67CM	23-25" / 60-64CM	30-32" / 76-81CM
XS	100-115 / 45-52	57-61" / 145-155CM	26-27" / 67-70CM	21-23" / 55-58CM	28-31" / 73-78CM
S	110-125 / 50-57	61-65" / 155-165CM	27-29" / 70-74CM	23-24" / 58-62CM	29-31" / 75-80CM
M	120-145 / 54-64	65-69" / 165-175CM	29-30" / 74-78CM	24-26" / 62-66CM	30-32" / 77-82CM
L	140-165 / 64-75	68-73" / 173-185CM	30-32" / 78-83CM	26-28" / 66-71CM	31-34" / 80-85CM
XL	165+ / 75+	73+" / 185+CM	32-34" / 82-87CM	27-30" / 70-75CM	33-35" / 84-89CM

RACER V3	WEIGHT (LB/KG)	A - HEIGHT (INCH/CM)	B - CHEST (INCH/CM)	C - WAIST (INCH/CM)	D - HIP (INCH/CM)
2XS	92-108 / 42-49	54-58" / 137-147CM	27-28" / 68-72CM	22-23" / 55-59CM	27-30" / 71-76CM
XS	100-115 / 45-52	57-61" / 145-155CM	27-29" / 70-74CM	22-24" / 57-61CM	28-31" / 73-78CM
S	110-125 / 50-57	61-65" / 155-165CM	28-30" / 72-77CM	23-25" / 59-64CM	29-31" / 75-80CM
M	120-145 / 54-64	65-69" / 165-175CM	29-31" / 74-79CM	24-26" / 61-66CM	30-32" / 77-82CM
L	140-165 / 64-75	68-73" / 173-185CM	31-34" / 79-85CM	26-28" / 66-72CM	31-33" / 79-84CM
XL	165+ / 75+	73+" / 185+CM	33-36" / 84-90CM	28-30" / 71-77CM	32-34" / 82-87CM

PURSUIT V3	WEIGHT (LB/KG)	A - HEIGHT (INCH/CM)	B - CHEST (INCH/CM)	C - WAIST (INCH/CM)	D - HIP (INCH/CM)
2XS	92-108 / 42-49	54-58" / 137-147CM	27-28" / 71-75CM	22-24" / 58-62CM	28-30" / 73-78CM
XS	100-115 / 45-52	57-61" / 145-155CM	28-30" / 73-77CM	23-25" / 60-64CM	29-31" / 75-80CM
S	110-125 / 50-57	61-65" / 155-165CM	29-31" / 75-80CM	24-26" / 62-67CM	30-32" / 77-82CM
M	120-145 / 54-64	65-69" / 165-175CM	30-32" / 77-82CM	25-27" / 64-69CM	31-33" / 79-84CM
L	140-165 / 64-75	68-73" / 173-185CM	32-35" / 82-88CM	27-30" / 69-75CM	32-34" / 82-87CM
XL	165+ / 75+	73+" / 185+CM	34-37" / 87-93CM	29-31" / 74-80CM	34-36" / 85-90CM

LIMITLESS	WEIGHT (LB/KG)	A - HEIGHT (INCH/CM)	B - CHEST (INCH/CM)	C - WAIST (INCH/CM)	D - HIP (INCH/CM)
XS	100-115 / 45-52	57-61" / 145-155CM	27-29" / 70-74CM	22-24" / 57-61CM	28-31" / 73-78CM
S	110-125 / 50-57	61-65" / 155-165CM	28-30" / 72-77CM	23-25" / 59-64CM	29-31" / 75-80CM
M	120-145 / 54-64	65-69" / 165-175CM	29-31" / 74-79CM	24-26" / 61-66CM	30-32" / 77-82CM
L	140-165 / 64-75	68-73" / 173-185CM	31-34" / 79-85CM	26-28" / 66-72CM	31-33" / 79-84CM
XL	165+ / 75+	73+" / 185+CM	33-36" / 84-90CM	28-30" / 71-77CM	32-34" / 82-87CM

KIDS

STINGRAY	WEIGHT (LB/KG)	A - HEIGHT (INCH/CM)
2	25-35 / 11-16	33-39" / 84-99CM
4	35-45 / 16-20	40-44" / 101-112CM
6	42-47 / 19-22	45-47" / 114-119CM
8	47-54 / 21-25	48-50" / 122-127CM
10	55-70 / 25-32	51-56" / 130-142CM
12	73-84 / 33-38	55-60" / 140-152CM

SWIMWEAR

INSIGHTFUL &
SUSTAINABLE

Aquasphere swimwear *chlorine-resistant fabric mixed to the right amount of stretch offers **durability, functionality and comfort.** This year, we are proud to introduce sustainable fabric to our **swimwear.***



MATRIX

PERFORMANCE

The Matrix Tech Suit is a **top-of-the-line FINA** approved competitive tech suit created with propriety **Exo-Core technology**. *It features both adaptive compression material to reduce muscle vibration and drag while ensuring maximum flexibility and freedom of movement.* In addition, **the Matrix** includes a sustaining tape system for improved body position by utilizing front and back axis tape and **cross-coordinating to improve length and position.**



RESEARCH & DEVELOPMENT

>>> 5000 HOURS OF TESTING

- Full dedicated team of 6 athletes, coaches and scientists
- Tested on 100+ athletes
- Granada university of sport science & a tech team involved
- Made in Italy

>>> CORE FEATURES

- Exo core Technology – Greater compression and range of motion
- Combines 2 fabrics:
 - Adapted Compression: high level of compression and progressive stretch to control muscle vibration
 - Jacquard: reduce drag and maximize muscle flexibility

>>> SUSTAINING TAPE CAGE - IMPROVE LENGTH & BODY POSITION

- The structure that snaps back allows greater propulsion.
- Cross-coordinating front and back axis tape offers horizontal buoyancy.



SUSTAINING
TAPES SYSTEMS



 <p>NEW</p>	 <p>NEW</p>		
<p>>>> CLOSE Back <<<</p> <p>CW0150471</p> <p>US: 26/28/30/32/34/36/38/40</p> <p>CW0140471</p> <p>EU: 26/28/30/32/34/36/38/40</p>	<p>>>> OPEN Back <<<</p> <p>CW0170471</p> <p>US: 26/28/30/32/34/36/38/40</p> <p>CW0160471</p> <p>EU: 26/28/30/32/34/36/38/40</p>	<p>>>> CLOSE Back <<<</p> <p>CW0150101</p> <p>US: 26/28/30/32/34/36/38/40</p> <p>CW0140101</p> <p>EU: 26/28/30/32/34/36/38/40</p>	<p>>>> OPEN Back <<<</p> <p>CW0170101</p> <p>US: 26/28/30/32/34/36/38/40</p> <p>CW0160101</p> <p>EU: 26/28/30/32/34/36/38/40</p>



JACQUARD THREAD FABRIC

- Reduced drag
- 4-way stretch allows for maximum muscle flexibility
- 55% Polyamide / 45% Elastane

SUSTAINING TAPE CAGE

- Structure snaps back
- Greater propulsion
- Horizontal buoyancy

EXO-CORE TECHNOLOGY

- Combination of the 2 fabrics
- Greater compression and range of motion

ADAPTED COMPRESSION PROGRESSIVE FABRIC

- Muscles vibrating control
- Striped fabric provides high level of compression and one-way progressive stretch (vertical)
- 53% Polyamide / 33% Elastane / 13% Polyester / 1% Metal

>>> **OTHER FEATURES**

- Water repellent fabrics: reduce drag



JACQUARD THREAD FABRIC

- Reduced drag
- 4-way stretch allows for maximum muscle flexibility
- 55% Polyamide / 45% Elastane

ADAPTED COMPRESSION PROGRESSIVE FABRIC

- Muscles vibrating control
- Striped fabric provides high level of compression and one-way progressive stretch (vertical)
- 53% Polyamide / 33% Elastane / 13% Polyester / 1% Metal

EXO-CORE TECHNOLOGY

- Combination of the 2 fabrics
- Greater compression and range of motion



SUSTAINING TAPE CAGE

- Structure snaps back
- Greater propulsion
- Horizontal buoyancy

OTHER FEATURES

- Water repellent fabrics: reduce drag



SIZING CHART

MATRIX TECH SUIT - MAN

SIZES	A - WAIST (INCH/CM)	B - HIP (INCH/CM)	FR	DE / A / CH	IT	USA	UK / AUS
50	26-27" / 66-69CM	30-32" / 78-82CM	50	000	34	20	2
55	27-28" / 69-71CM	32-33" / 82-84CM	55	00	36	22	4
60	28-29" / 71-74CM	33-34" / 84-87CM	60	0	38	24	6
65	29-30" / 74-76CM	34-36" / 87-92CM	65	1	40	26	8
70	30-31" / 76-79CM	36-38" / 92-97CM	70	2	42	28	10
75	31-32" / 79-81CM	38-39" / 97-99CM	75	3	44	30	12
80	32-33" / 81-84CM	39-40" / 99-102CM	80	4	46	32	14
85	33-34" / 84-87CM	40-41" / 102-104CM	85	5	48	34	16

MATRIX TECH SUIT - WOMAN

SIZES	A - CHEST (INCH/CM)	B - WAIST (INCH/CM)	C - HIP (INCH/CM)	D - BODY LOOP (INCH/CM)	FR	DE / A / CH	IT	USA	UK / AUS
26	25-27" / 64-70CM	20-22" / 51-56CM	28-30" / 71-76CM	53-54" / 135CM	26	24	30	20	
28	27-32" / 70-81CM	22-24" / 56-61CM	30-32" / 76-81CM	55-56" / 140CM	28	26	32	22	0
30	32-33" / 81-84CM	24-26" / 61-66CM	32-34" / 81-87CM	57-58" / 145CM	30	28	34	24	2
32	33-35" / 84-89CM	26-28" / 66-71CM	34-36" / 87-92CM	59-60" / 150CM	32	30	36	26	4
34	35-36" / 89-92CM	28-29" / 71-74CM	36-38" / 92-97CM	61-62" / 155CM	34	32	38	28	6
36	36-38" / 92-97CM	29-30" / 74-76CM	38-40" / 97-102CM	63-64" / 160CM	36	34	40	30	8
38	38-39" / 97-99CM	30-31" / 76-79CM	40-42" / 102-107CM	65-66" / 165CM	38	36	42	32	10
40	39-40" / 99-102CM	31-32" / 79-81CM	42-44" / 107-112CM	67-68" / 170CM	40	38	44	34	12



SWIMWEAR FABRICS

SUSTAINABILITY

We are proud to introduce two sustainable fabrics to our swimwear. All the Essential training suits are made from 2 to 5 plastic bottles!

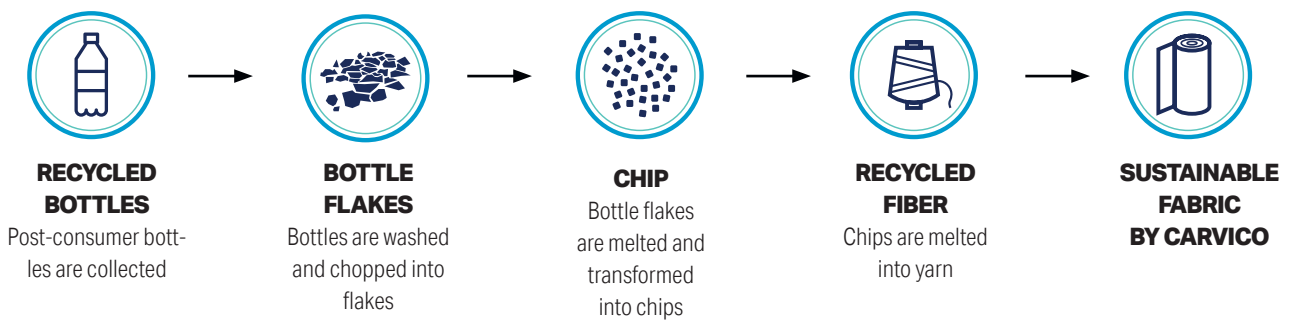

SUSTAINABLE FABRICS

100%
POLYESTER

55% recycled PL + 45% P.B.T.

MELVILLE

Melville sustainable fabric is designed to last through any intense training of Elite athletes.



AVAILABLE FOR:

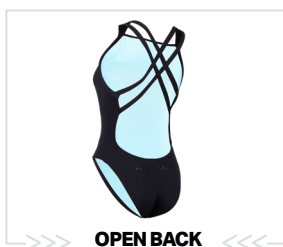

78%
recycled PL

+ 22% ELASTOLEFIN

X-PLAY

X-Play sustainable fabric is designed to assure support and comfort during fitness swim training.



AVAILABLE FOR:

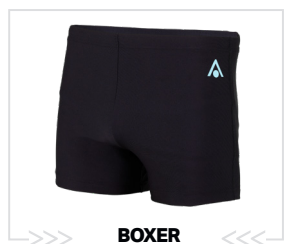

BRIEF8CM

ESSENTIALS



>>> The Essential Brief 8cm has been designed to last through any intense training. Crafted with Melville sustainable fabric, it allows a compressive and breathable fit while guaranteeing long lasting comfort.

This training suit is made of 2 plastic bottles!*



chlorine proof



recycled yarn



shape retention



pilling resistant



two-way stretch

100%
Chlorine resistant

FULLY LINED
Long-lasting comfort



SM4740141

BLACK LIGHT BLUE

65/70/75/80/85/90/95

NEW



SM4749940

MULTICOLOR BLUE

65/70/75/80/85/90/95



SM4740406

NAVY BLUE RED

65/70/75/80/85/90/95

OTHER FEATURES

- Durable Fabric Elasticity
- Melville composition:
45% polyester from PBT
55% recycled polyester derived from PET bottles

* Based on 1L bottle and size 85

BRIEF 14CM

ESSENTIALS

>>> The Essential Brief 14cm has been designed to last through any intense training. Crafted with Melville sustainable fabric, it allows a compressive and breathable fit while guaranteeing long lasting comfort.

This training suit is made of 2 plastic bottles!*

- 
chlorine proof
- 
recycled yarn
- 
shape retention
- 
pilling resistant
- 
two-way stretch



100%
Chlorine resistant

FULLY LINED
Long-lasting comfort



SM4770141
BLACK LIGHT BLUE

65/70/75/80/85/90/95



SM4779940
MULTICOLOR BLUE

65/70/75/80/85/90/95



SM4770406
NAVY BLUE RED

65/70/75/80/85/90/95

OTHER FEATURES

- Durable Fabric Elasticity
- Melville composition:
45% polyester from PBT
55% recycled polyester derived from PET bottles

* Based on 1L bottle and size 85

BOXER

ESSENTIALS

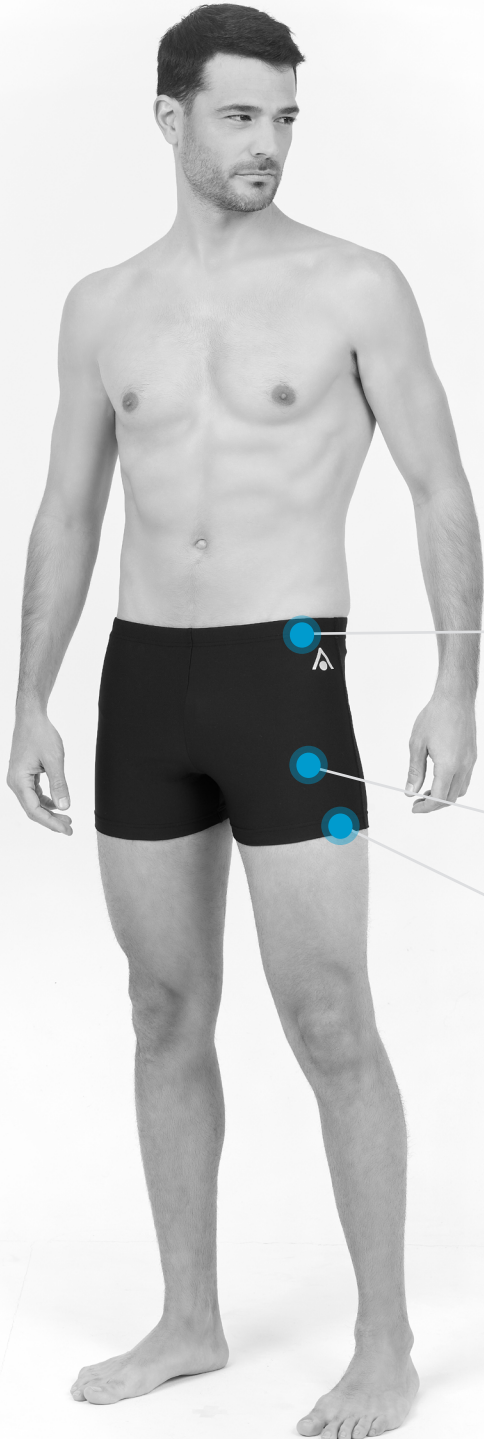

>>> The Essential Boxer has been designed to guarantee long lasting comfort during swim training. Crafted with X-Play sustainable fabric, it allows high flexible fit guaranteeing greater range of motion.

This training suit is made of 3 plastic bottles!*



100%
Chlorine resistant

FULLY LINED
Long-lasting comfort

INNER BRIEF



>>> **SM4750141** <<<<
BLACK LIGHT BLUE
65/70/75/80/85/90/95



>>> **SM4750606** <<<<
RED
65/70/75/80/85/90/95



>>> **SM4750406** <<<<
NAVY BLUE RED
65/70/75/80/85/90/95

OTHER FEATURES

- Durable Fabric Elasticity
 - X-Play composition: 78% Recycled Polyester (100% regenerated from PET plastic bottles) + 22 % Elastofin
- * Based on 1L bottle and size 85

JAMMER

ESSENTIALS

>>> The Essential Jammer has been designed to assure long lasting comfort during swim training. Crafted with X-Play sustainable fabric, it allows high flexible fit guaranteeing greater range of motion.

This training suit is made of 5 plastic bottles!*

- 
chlorine proof
- 
recycled yarn
- 
four-way stretch
- 
breathable
- 
pilling resistant

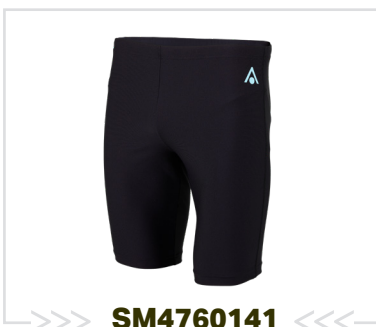
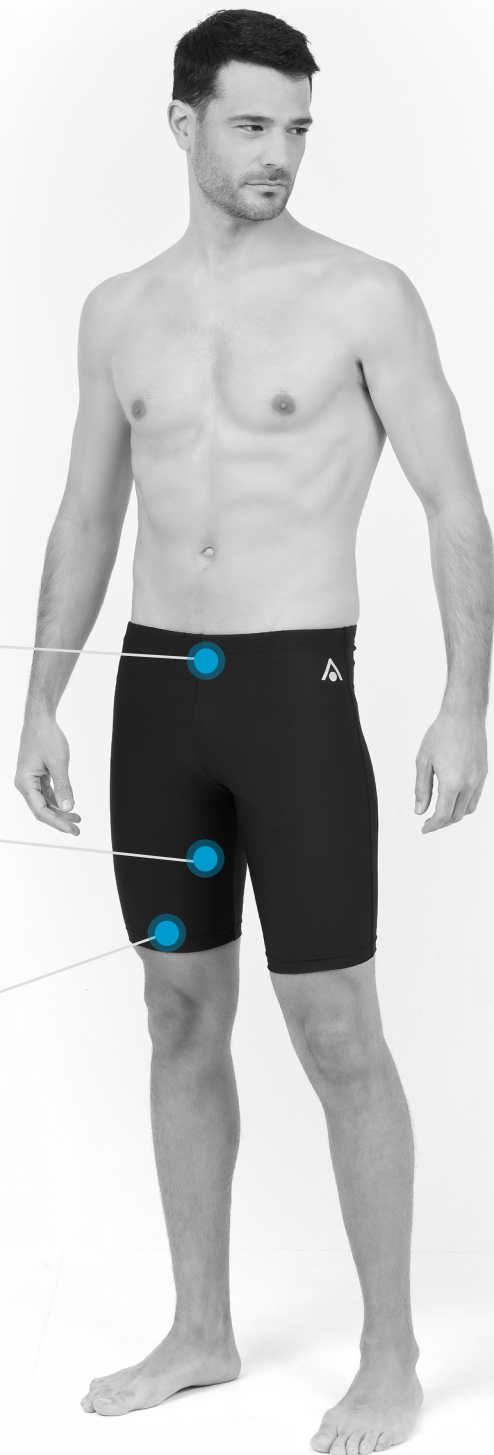

>>> **SM4760141** <<<<
BLACK LIGHT BLUE
65/70/75/80/85/90/95



>>> **SM4761206** <<<<
DARK GREY RED
65/70/75/80/85/90/95



>>> **SM4760406** <<<<
NAVY BLUE RED
65/70/75/80/85/90/95

OTHER FEATURES

- Durable Fabric Elasticity
 - X-Play composition: 78% Recycled Polyester (100% regenerated from PET plastic bottles) + 22 % Elastolefin
- * Based on 1L bottle and size 85

TIEBACK

ESSENTIALS

>>> The Essential Tie Back has been designed to last through any intense training. Crafted with Melville sustainable fabric, it allows a compressive and breathable fit while guaranteeing long lasting comfort.

This training suit is made of 3 plastic bottles!*

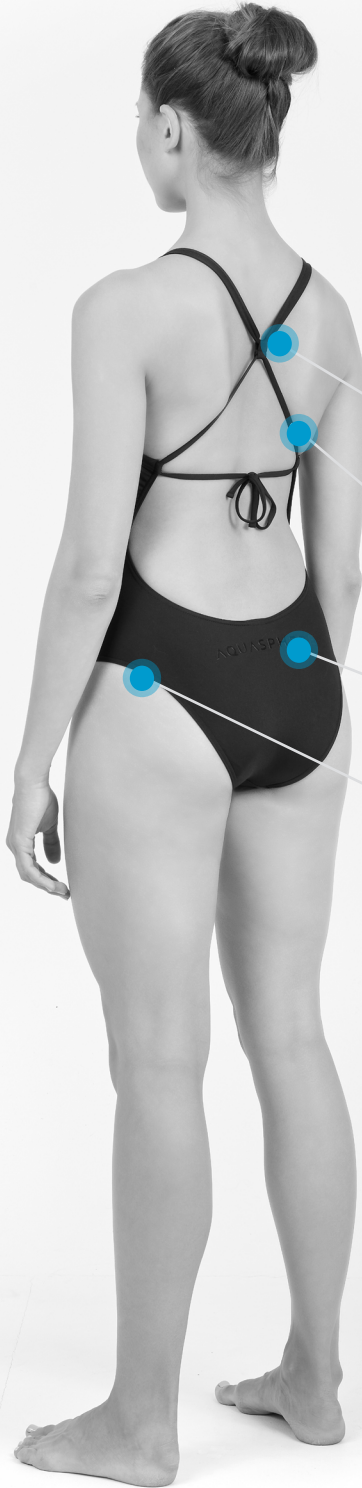

TIE BACK
Adjust chest fitting

DURABLE SILICONE STRAPS
Long-lasting comfort

100%
Chlorine resistant

HIGH-LEG CUT
Greater range of motion



SW4690101
BLACK BLACK

34/36/38/40/42/44/46/48

NEW

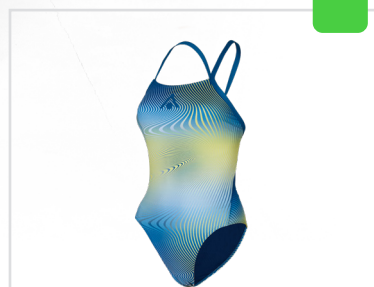

SW4699940
MULTICOLOR BLUE

34/36/38/40/42/44/46/48



SW4690406
NAVY BLUE RED

34/36/38/40/42/44/46/48

OTHER FEATURES

- Durable Fabric Elasticity
- Double lining
- Melville composition: 45% polyester from PBT 55% recycled polyester derived from PET bottles

* Based on 1L bottle and size FR 36

OPENBACK

ESSENTIALS

>>> The Essential Open Back has been designed to last through any intense training. Crafted with Melville sustainable fabric, it allows a compressive and breathable fit while guaranteeing long lasting comfort.

This training suit is made of 3 plastic bottles!*

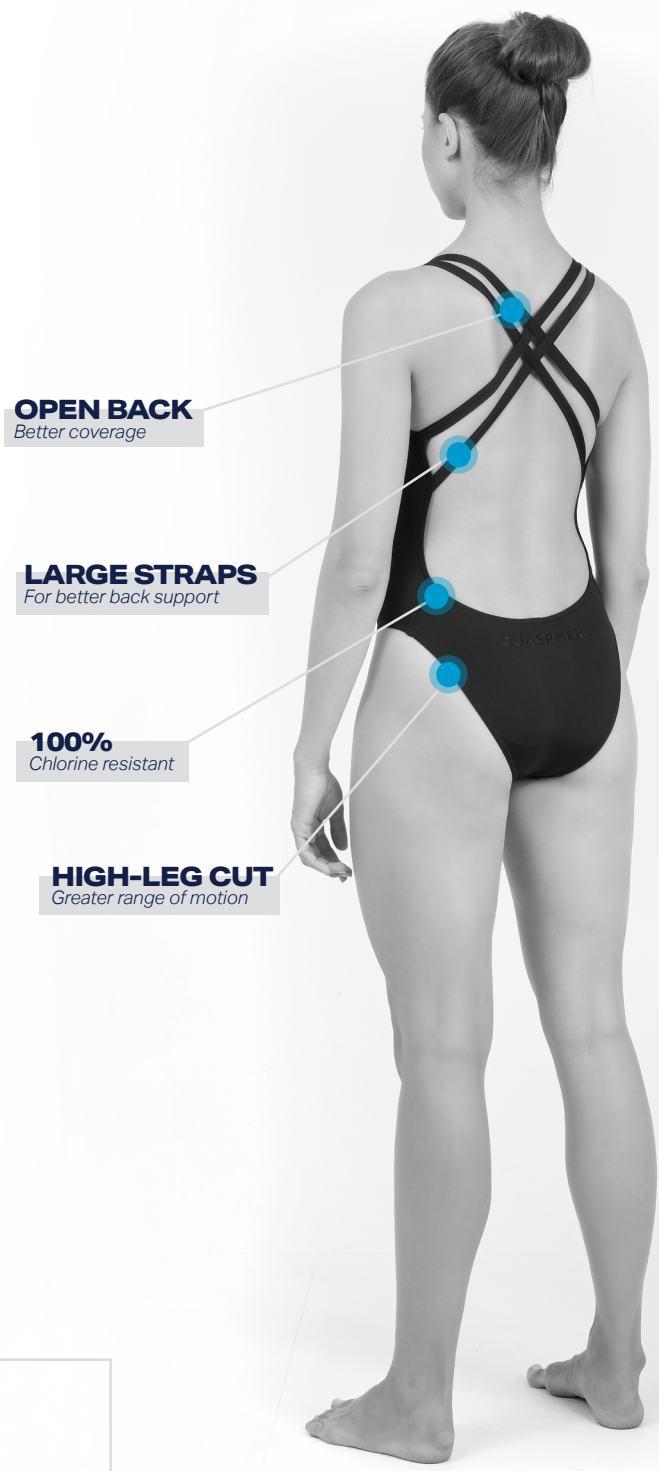

SW4700101
BLACK BLACK

34/36/38/40/42/44/46/48



SW4709940
MULTICOLOR BLUE

34/36/38/40/42/44/46/48

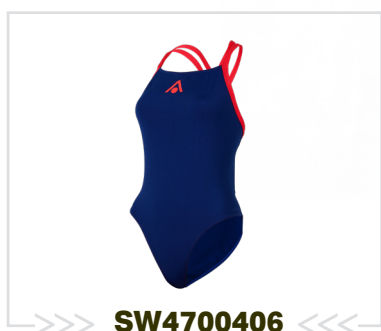

SW4700406
NAVY BLUE RED

34/36/38/40/42/44/46/48

OTHER FEATURES

- Durable Fabric Elasticity
- Double lining
- Melville composition: 45% polyester from PBT 55% recycled polyester derived from PET bottles
- * Based on 1L bottle and size FR 36

WIDEBACK

ESSENTIALS

>>> The Essential Wide Back has been designed to assure long lasting comfort during swim training. Crafted with X-Play sustainable fabric, it allows high flexible fit guaranteeing greater range of motion.

This training suit is made of 4 plastic bottles!*



WIDE BACK
Better water sensation

THIN STRAPS
Long-lasting comfort

100%
Chlorine resistant

MIDDLE-LEG CUT
Greater coverage



SW4660101
BLACK BLACK

34/36/38/40/42/44/46/48

NEW

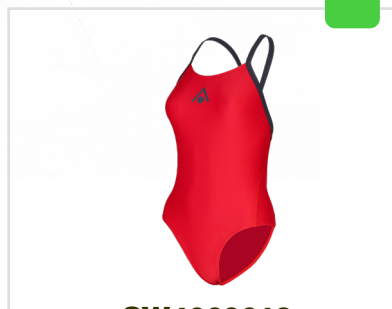

SW4660612
RED DARK GREY

34/36/38/40/42/44/46/48

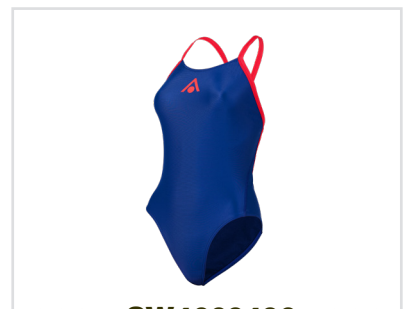

SW4660406
NAVY BLUE RED

34/36/38/40/42/44/46/48

OTHER FEATURES

- Durable Fabric Elasticity
- Double lining
- X-Play composition: 78% Recycled Polyester (100% regenerated from PET plastic bottles) + 22 % Elastolefin

* Based on 1L bottle and size 36

FLYBACK

ESSENTIALS

>>> The Essential Fly Back has been designed to assure long lasting comfort during swim training. Crafted with X- Play sustainable fabric, it allows high flexible fit guaranteeing greater range of motion.

This training suit is made of 4 plastic bottles!*

- 
chlorine proof
- 
recycled yarn
- 
four-way stretch
- 
breathable
- 
pilling resistant

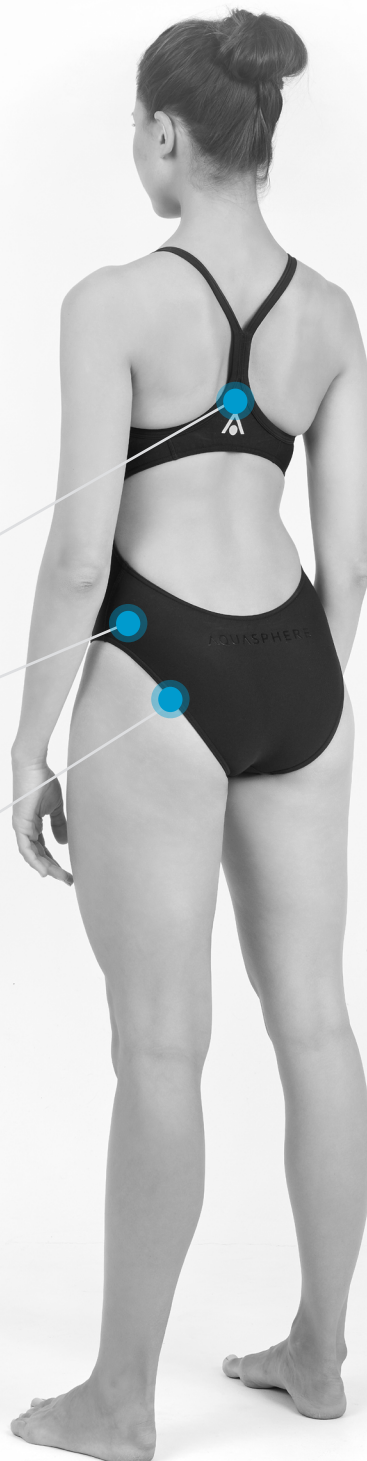

FLY BACK
Greater flexibility

100%
Chlorine resistant

MIDDLE-LEG CUT
Greater coverage



SW4670101
BLACK BLACK

34/36/38/40/42/44/46/48

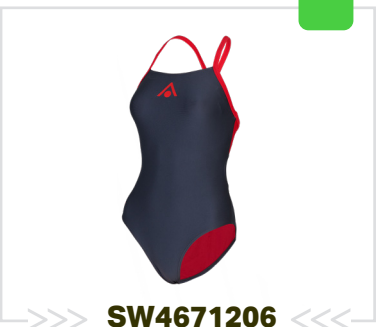

SW4671206
DARK GREY RED

34/36/38/40/42/44/46/48

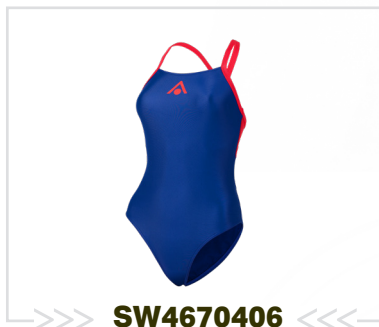

SW4670406
NAVY BLUE RED

34/36/38/40/42/44/46/48

OTHER FEATURES

- Durable Fabric Elasticity
- Double lining
- X-Play composition: 78% Recycled Polyester (100% regenerated from PET plastic bottles) + 22 % Elastolefin

* Based on 1L bottle and size 36

CLASSICBACK

ESSENTIALS

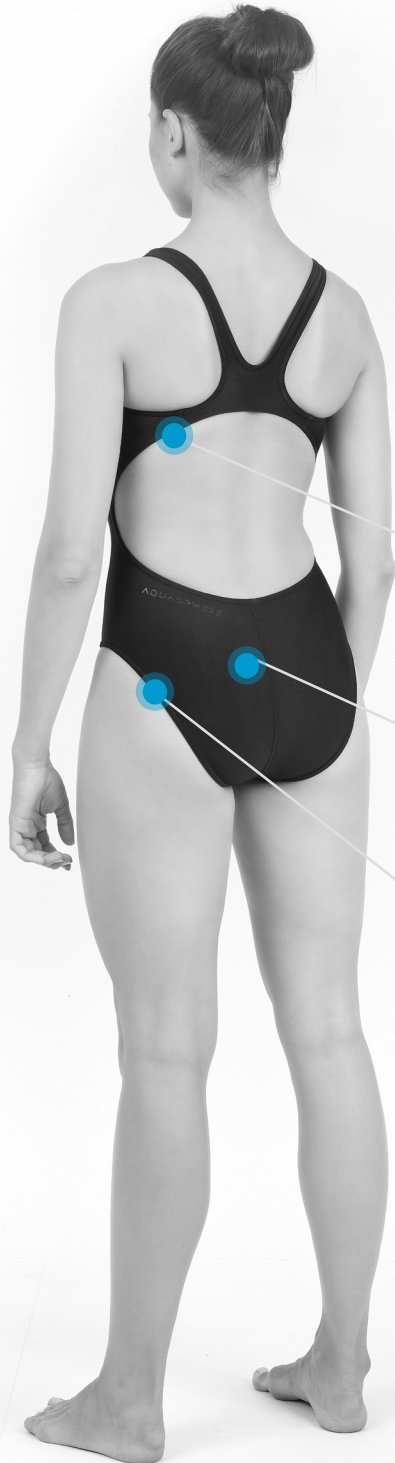

The Essential Classic Back has been designed to assure long lasting comfort during swim training. Crafted with X- Play sustainable fabric, it allows high flexible fit guaranteeing greater range of motion.

This training suit is made of 4 plastic bottles!*



CLASSIC BACK
Greater coverage & better stability

100%
Chlorine resistant

MIDDLE-LEG CUT
Greater coverage



SW4680101
BLACK BLACK

34/36/38/40/42/44/46/48

NEW

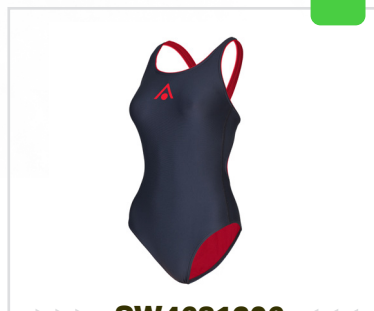

SW4681206
DARK GREY RED

34/36/38/40/42/44/46/48

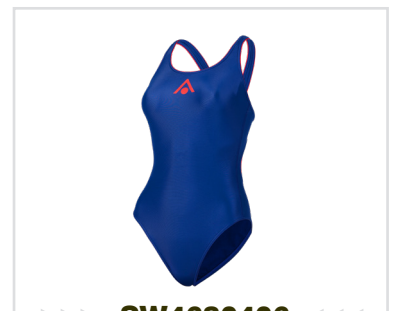

SW4680406
NAVY BLUE RED

34/36/38/40/42/44/46/48

OTHER FEATURES

- Durable Fabric Elasticity
- Double lining
- X-Play composition: 78% Recycled Polyester (100% regenerated from PET plastic bottles) + 22% Elastolefin

* Based on 1L bottle and size 36



SIZING TRAINING CHART

TRAINING SUIT - MEN

ESSENTIALS	A - WAIST (CM)	B - HIP (CM)
65	65	84
70	70	88
75	75	90
80	80	95
85	85	100
90	90	105
95	95	110

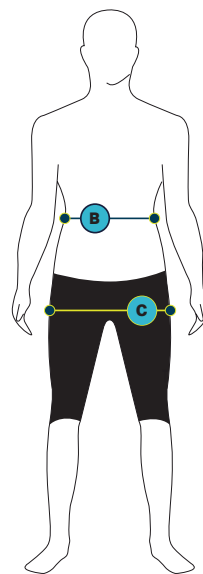
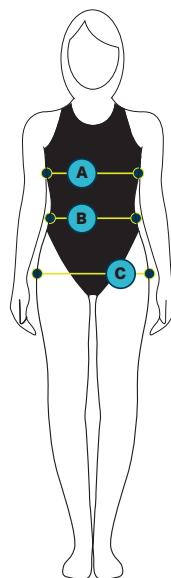

TRAINING SUIT - WOMEN

ESSENTIALS	A - CHEST (CM)	B - WAIST (CM)	C - HIP (CM)
32	75	60	80
34	80	65	85
36	85	70	90
38	90	75	95
40	95	80	100
42	100	85	105
44	105	90	110
46	110	95	115
48	115	100	120

TRAINING GEAR & ACCESSORIES

Our commitment to innovation leads us to design tailored training equipment and accessories dedicated to developing specific workouts and muscle groups to achieve an individual's personal training requirements.

TAKE CARE OF YOUR SWIM GOGGLE

SEA-CLR ECO FRIENDLY ANTI-FOG



SA2040940

SEA-CLR PEN

SA2130040

SEA-CLR SPRAY

FEATURES

- Clean and restore plastic lenses for swim goggles
- Crystal vision and anti-fog guard
- Environmentally safe
- Physiologically safe
- Anti-fog
- Scratch-resistant
- No eye irritation
- Reef safe formula
- Made in Italy

SWIM MASK AND GOGGLE CASE EYEWEAR STORAGE CASE

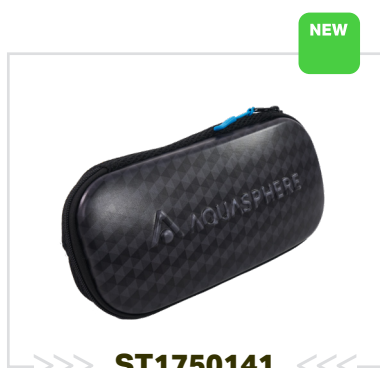

ST1750141

SWIM MASK CASE

110 x 230 mm



ST1760106

SWIM GOGGLE CASE

80 x 190 mm

FEATURES

- Fits and protects all your small accessories
- Two inner pocket for valuables (anti-fog, nose clip, ear plugs...)
- 3D mesh for ventilation against moisture
- EVA thermoformed case to protect and resist against impacts

FOCUS SNORKEL

SWIM TRAINING SNORKEL



HYDRODYNAMIC TUBE

Reduces drag and eases breathing

ADJUSTABLE & LIGHTWEIGHT HEAD BRACKET

Greater stability and comfortable fit

ONE WAY PURGE VALVE

Maximizes clearing of excess water

FEATURES

- Low profile & triangular shape: quick water clearing
- Integrated cushion in head bracket : maximum comfort
- Silicone piece for the palate inspired from scuba diving: greater stability and comfort
- Soft silicone mouth piece: minimize jaw fatigue

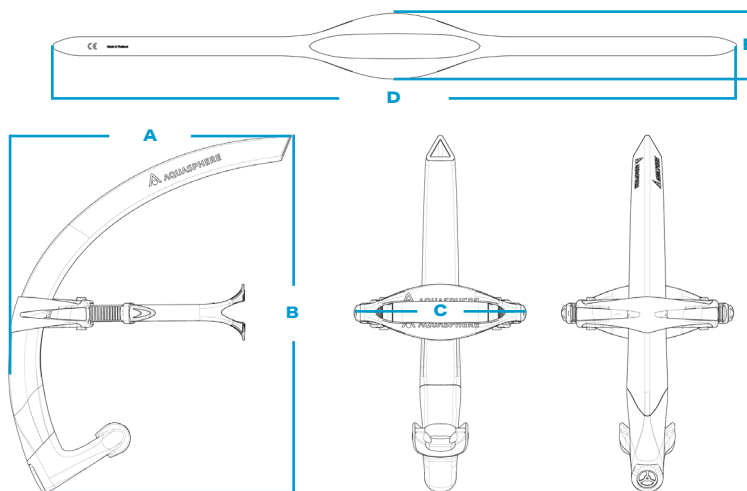

OUR SIZES	A-WIDTH (CM)	B-HEIGHT (CM)	C-BASE WIDTH (CM)	D-STRAP WIDTH (CM)	E-STRAP HEIGHT (CM)
SMALL FIT	25,5	33,9	12,1	57,6	5,5
REGULAR FIT	27,5	34,9	14	57,6	5,5



GEAR MESH BACKPACK

EQUIPMENT BAG 30ML

RIGID ROLL TOP OPENING
For easy loading

MESH FABRIC
Allows maximum breathing and quick drying



POLYESTER 210D PU RIPSTOP
Lightweight and resistant to heavy loading



SA2170401
NAVY BLACK
 55 x 36 x 15,5 cm

FEATURES

- Fits all your wet equipment (pull buoy, kickboard, focus snorkel...)
- 2 ways of closing: from the top or on the side to adapt to the volume of your equipment
- Adjustable shoulder straps: allows to wear as backpack for comfort.
- One outside zip pocket: store your small accessories (eyewear, nose clip, ear plugs...)
- One outside mesh bottle pocket

PULL BUOY

UPPER BODY CONDITIONING



ST1520471
NAVY BRIGHT YELLOW

FEATURES

- Maximizes upper body workout by immobilizing the legs
- Isolates the arm motion to improve stroke form, strengthen and tone
- High density EVA foam with an ergonomic shape
- Durable and will not waterlog

KICKBOARD

LOWER BODY CONDITIONING

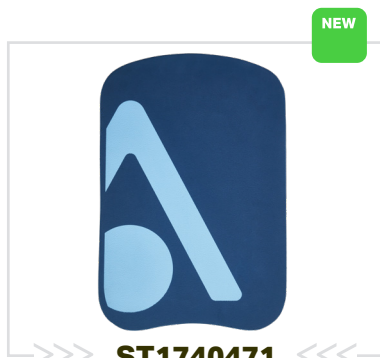

ST1740471
NAVY BRIGHT YELLOW

FEATURES

- Maximizes lower body workout by immobilizing the upper body
- High density EVA foam
- Textured to protect against scratches
- Durable and will not waterlog

TRI-CAP

ADULT SWIM CAP

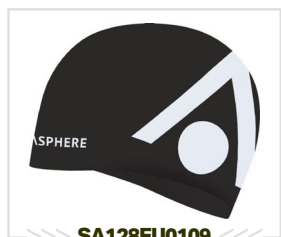

SA128EU0109
BLACK WHITE

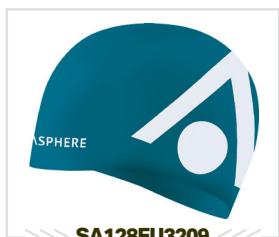

SA128EU3209
DARK GREEN WHITE

FEATURES

- Designed for training and competition
- Semi-formed shape
- Durable chlorine-resistant Silicone



SA128EU0806
ORANGE RED



SA128EU0601
RED BLACK



SA128EU7110
BRIGHT YELLOW GREY

Race CAP

ADULT SWIM CAP



SA218EU0109
BLACK WHITE

FEATURES

- Provides a streamlined and competitive fit
- 3D cut for comfort and perfect fit
- Reduces wrinkles and drag
- 100% silicone



SA218EU0901
WHITE BLACK



SA218EU0471
NAVY BRIGHT YELLOW



AQUA COMFORT

ADULT SWIM CAP



SA216EU0101
BLACK

FEATURES

- Adjustable, ultra-lightweight and comfortable for the casual aquatic enthusiast
- Adjustable headband
- Ultra lightweight, quick-drying and durable
- 90% Polyester, 10% Rubber

PLAINCAP

ADULT SWIM CAP



SA212EU0109
BLACK WHITE



SA212EU3209
DARK GREEN WHITE



SA212EU2209
DARK PINK WHITE



SA212EU0601
RED BLACK



SA212EU0901
WHITE BLACK

FEATURES

- Designed for training and competition
- Semi-formed shape
- Durable chlorine-resistant Silicone

MICROFIN & MICROFIN Jr

LEG WORKOUT



FEATURES

- Rigid sole helps prevent cramping
- Closed foot pocket made of durable and ultrasoft TPR polymer
- Anti-slip rubber pads for grip on slippery surfaces
- Improves technique
- Muscles reinforcement

	USA	EU	SIZE
MICROFIN JR	10-13 ^{1/2}	27-31	S
MICROFIN JR	1-3 ^{1/2}	32-35	M
MICROFIN	4-5	36-37	XS
MICROFIN	5-6	38-39	S
MICROFIN	6-7	40-41	M
MICROFIN	8-9	42-43	L
MICROFIN	9 ^{1/2} -10 ^{1/2}	44-45	XL
MICROFIN	11/12	46-47	XXL

ZIP VX

INCREASE THRUST AND BODY POSITION



FA3274010

US: S/M/L

FA327EU4010

EU: S/M/L



FA3270110

US: S/M/L

FA327EU0110

EU: S/M/L

FEATURES

- Leverages natural kicking motion
- Hole in the blade for increased thrust
- Narrow blade improves kicking mechanics
- Easy-adjust buckles for a custom fit
- Non-slip pads on fin rails provide traction

USA	EU	SIZE
M 4-7 W 5-8	35-40	S
M 7-10 W 8-11	40-44	M
M 10-13 W 11-14	44-48	L

ALPHA FINNS

LEG AND BODY POSITION



FA3244040

US: XXS/XS/S/M/L/XL/XXL

FA324EU4040

EU: XXS/XS/S/M/L/XL/XXL

FEATURES

- Provides isolated leg workout
- Buoyancy improves body position
- Water channels provide stability and maximum power transfer
- Dedicated right and left fins with full arch support
- Made of non-water logging, EVA foam

USA	EU	SIZE
W 4-6	33-35	XXS
W 6-8 M 3-6	35-38	XS
W 8-10 M 6-8	38-41	S
W 10-12 M 8-10	41-44	M
W 12-13 M 10-11 ^{1/2}	44-45 ^{1/2}	L
W 13-14 M 11 ^{1/2} -13	45 ^{1/2} -47	XL
M 13-14	47-48 ^{1/2}	XXL

ERGO FLEX

HAND PADDLES



FEATURES

- Interconnected «bones» provide structure and resistance
- Rubber frame maintains flexibility and feel for the water
- Contoured fit mimics proper hand positioning and can flex to fit individual stroke mechanics
- Wide, adjustable hand strap for custom fit

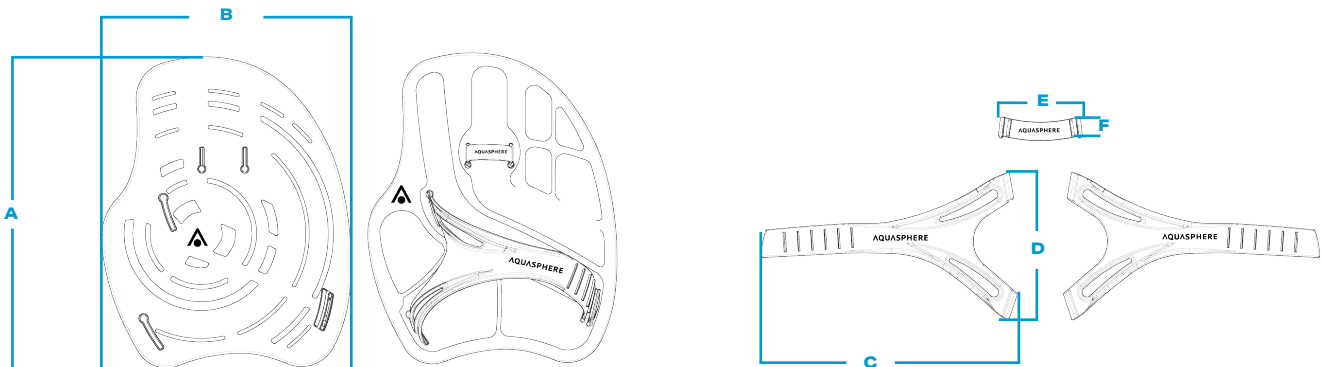

OUR SIZES	A-HEIGHT (CM)	B - WIDTH (CM)	C - STRAP WIDTH (CM)	D - STRAP HEIGHT (CM)	E - FINGER RING WIDTH (CM)	F - FINGER RING HEIGHT (CM)
S	18,7	15,1	18,6	10,6	6,1	1,5
M	22,5	18,1	23,4	13,1	6,6	1,5

SWIM GLOVES

LOW IMPACT RESISTANCE



ST1704040

US: S/M/L

ST170EU4040

EU: S/M/L

FEATURES

- Neoprene construction is comfortable, durable and quick drying
- Webbed fingers provide low-impact resistance
- Hook & loop wrist closure ensures secure fit

PART		S	M	L	TOL +/-
A	HEIGHT	21.5	22.5	23.5	1
B	BOTTOMWIDTH	5.5	6	6.5	0.5
C	TOPWIDTH	22.5	23	26	1

AQUASTOP

WITH CASE



SA2150800

FEATURES

- Soft, silicone covered nose pads provide unparalleled comfort and a tight fit
- Reusable transparent case

EAR PLUGS x4

FOUR PLUGS WITH CASE



SA112EU4040

FEATURES

- Moldable, soft ear plugs made of hypoallergenic silicone
- Reusable transparent box
- Includes 4 units

