



 AQUASPHERE

BUYERS GUIDE SPRING SUMMER 2023

EYEWEAR

ADULTS

VISTA PRO	16
VISTA	18
VISTA XP	20
KAYENNE PRO	22
KAYENNE	24
KAYENNE COMPACT	26
KAIMAN EXO	28
XCEED	30
NINJA	32
FASTLANE	34
SEAL 2.0	36
EAGLE	39
KAIMAN	40
KAIMAN COMPACT	42

KIDS

VISTA JUNIOR	44
SEAL KID	46
KAYENNE JUNIOR	48

WETSUITS

RACER.BOOST	54
RACER.BOOST SHORTS	56
RACER.FLEX	58
RACER.ACTIVE	60
RACER.SWIMRUN	62
AQUASKIN	64
STINGRAY	67
SIZE CHARTS	68

TECHSUITS

RACER.SPEEDSUIT	72
MATRIX	74
SIZE CHARTS	77

SWIMWEAR

ESSENTIALS	82
SIZE CHARTS	91

SWIM EQUIPMENT & ACCESSORIES

ALL ACCESSORIES	92
-----------------	----

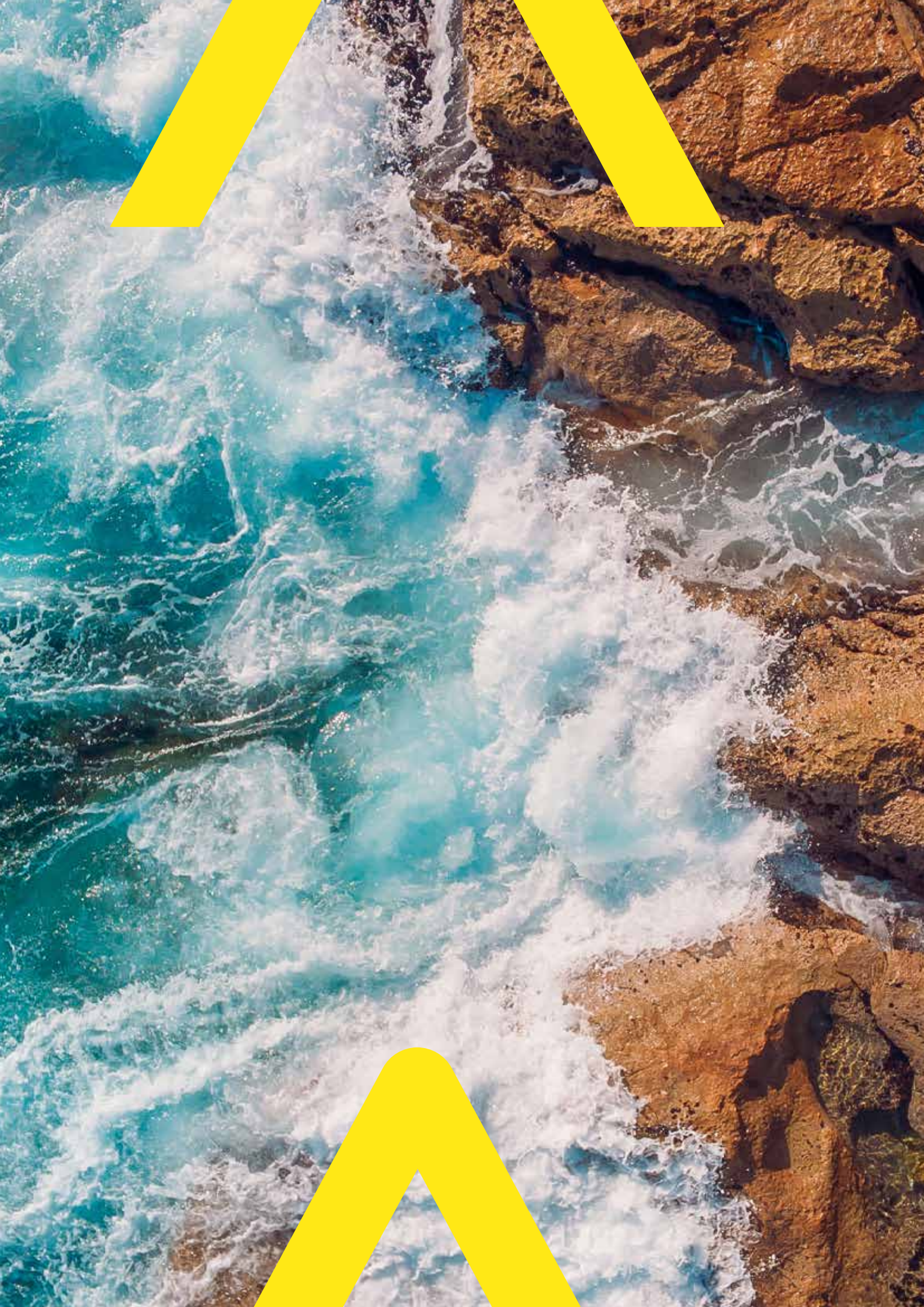



PATRICK LANGE

**YOUR PLAYGROUND.
YOUR CHALLENGES.
BE LIMITLESS.**



It's **not just swimming.**

It's about **breaking** *your personal barriers* and reaching **new horizons.**

It's about **embracing** *your individuality* while sharing your **PASSION.**

It's the **right** to be **real**, to be **BOLD.**

BORN IN 1998

Inspired by years of working in the scuba diving industry, it took the Italian engineers, P. Ferraro and G. Beltrani, two years of experimenting, testing and prototyping to finally patent the first curved lens with no visibility distortion: the Seal swim mask.

FROM CREATIVE *INGENUITY TO PERFORMANCE*

Sharpened over more than 30 years of research, Aquaphere's craftsmanship excellence is based on purposefully advanced and patented technologies, high-quality materials and driven by our swimming community.

AUTHENTIC *PASSION*

Whatever the playground, we gear the free-spirited swimmer and celebrate each individual in their pursuit of achievement.







EYEWEAR

CHALLENGE *DRIVEN*

Our passion for purposeful driven and innovative swim eyewear, keeps inspiring us to elevate our products to enhance our swimmers experience.

MADE IN *ITALY*

Through our in-house R&D Department and manufacturing facilities based in Italy, we design and craft swim eyewear that combine performance, reliability and comfort.

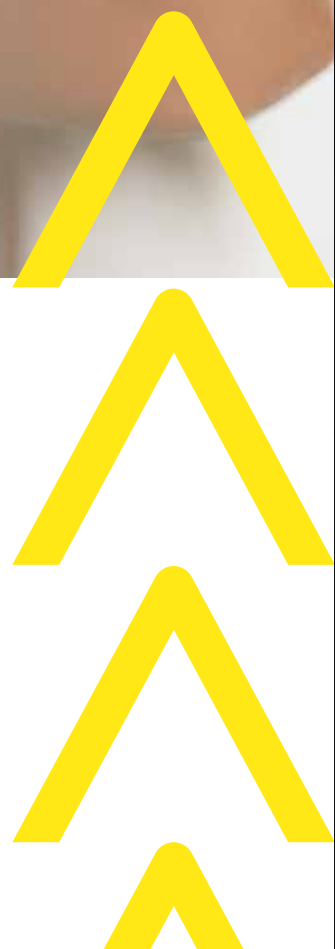

VISUAL CLARITY. REALIZED.

LENS GUIDE

SUNNY

PARTIALLY SUNNY

INDOOR / CLOUDY



- Maximum light protection
- Boost color contrast

- Decreased light transmission
- Reduced glare

- Maintain or enhance color contrast



SUNNY

SILVER

YELLOW

ORANGE



PARTIALLY SUNNY

SMOKE

BROWN POLARIZED



INDOOR / CLOUDY

CLEAR

BLUE TINTED

IRIDESCENT



TITANIUM MIRRORCO

PHOTOCHROMATIC LENSES

- Adapts to all conditions
- Increased light protection



LENS TECHNOLOGY

A full assortment of performance-engineered lenses in a wide range of tints to enhance our swimmers experience.



SILVER TITANIUM MIRRORED



- Ultimate Light Protection
- Maintain natural colors
- Infra red cut
- *light transmission : 13%*



YELLOW TITANIUM MIRRORED



- Maximum Light Protection
- Boosts Color Contrast
- Reduced glare



BROWN POLARIZED



- Decreased light transmission
- Reduced glare
- Enhances sharpness
- *light transmission : 11%*



ORANGE TITANIUM MIRRORED



- Maximum Light Protection
- Boosts Color Contrast
- Reduced glare
- *light transmission : 23%*



SMOKE



- Decreased light transmission
- Maintains color saturation
- Increases natural contrast
- *light transmission : 27% - 53%*

NEW

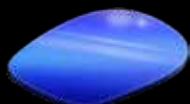

INDIGO TITANIUM MIRRORED



- Maximum Light Protection
- Boosts Color Contrast
- Reduced glare



PHOTOCHROMATIC



- Adapts to all conditions
- Changes with level of UV
- Increased light protection
- *light transmission : 25% - 78%*

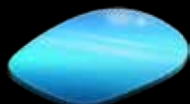

BLUE TITANIUM MIRRORED



- Maximum Light Protection
- Boosts Color Contrast
- Enhances warm color against blue
- *light transmission : 18% - 27%*



BLUE TINTED



- Increased contrast
- Reduced glare
- *light transmission : 58%*



RED TITANIUM MIRRORED



- Maximum Light Protection
- Boosts Color Contrast
- Infra red cut
- *light transmission : 18% - 43%*



IRIDESCENT MIRRORED



- Maximizes visibility
- Decreased light transmission
- *light transmission : 75% - 78%*



PINK TITANIUM MIRRORED



- Maximum Light Protection
- Boosts Color Contrast
- Increases contrast against blue water
- *light transmission : 24%*





































































































CLEAR



- Transmits natural light
- Maximizes visibility
- *light transmission : 88% - 92%*

Light Transmission may vary depending on skus.

	CLEAR	IRIDESCENT MIRRORED	TINTED	PHOTO CHROMATIC	SMOKE	POLARIZED	TITANIUM MIRRORED						
							PINK	RED	INDIGO	BLUE	ORANGE	YELLOW	SILVER
CONDITIONS	 	 		 									
 VISTA PRO													
 VISTA								 					
 VISTA XP													
 KAYENNE PRO													
 KAYENNE													
 KAYENNE COMPACT													
 KAIMAN EXO													
 XCEED							 						
 NINJA													
 FASTLANE							 						
 SEAL 2.0													
 EAGLE													
 KAIMAN													
 KAIMAN COMPACT													
 VISTA JR													
 SEAL KID													
 KAYENNE JR													

LENS FEATURES



CURVED LENS

Premium optical engineering and three critically placed radii let you experience a 180° field of vision.



ANTI-FOG

Durable anti-fog treatment for guaranteed clearer vision. Use our eco-friendly anti-fog solution Sea-Clr Antifog spray for extra protection.



LIGHT PROTECTION

Embedded within the lens' material (polycarbonate and plexisol), the properties of our lenses protect your eyes from harmful rays.



FRAME FEATURES

A·F·T

ADVANCED FIT TECHNOLOGY

The dual texture and dual-density soft grip on the face reduces skin marks while ensuring a water-tight seal for focused performance.

AVAILABLE FOR: VISTA PRO, KAYENNE PRO, NINJA, KAIMAN EXO, SEAL 2.0

EXO CORE

Bi-material frame technology combines exceptional stability with maximum comfort. A semi-rigid exoskeleton protects the lens with an integrated structure, while the ultra-soft Softeril material creates a streamlined, lightweight design.

AVAILABLE FOR: XCEED, NINJA, KAIMAN EXO.



ADJUSTABLE NOSE BRIDGE

The adjustable nose bridge ensures a snug, leak-free seal that adapts to any face shape.

AVAILABLE FOR: KAYENNE PRO, XCEED, NINJA, FASTLANE.

R·F·S

RACE FIT SYSTEM

Customise your fit just once and ensure perfect fit and stability every time.

AVAILABLE FOR: NINJA



PIVOTING BUCKLE

An adjustable, rotating buckle ensures the fit every time for any head shape.

AVAILABLE FOR: VISTA PRO



QUICK FIT

Easy push button to tighten or loosen your goggles while still wearing them.

AVAILABLE FOR: VISTA PRO, KAYENNE PRO, KAYENNE, VISTA, VISTA JUNIOR



E-Z ADJUST

Low profile strap allows for precise adjustment. Simply pull the straps back to your desired level of tension for a leak free fit or lift the buckle tabs and pull the goggle forward to loosen.

AVAILABLE FOR: KAIMAN EXO, KAIMAN, SEAL 2.0, KAYENNE JUNIOR, EAGLE, SEAL KID





VISTA**PRO**

PERFORMANCE

>>> Designed with the Open Water Adventure Swimmer in mind, the Vista Pro offers great field of vision through its curved single lens. Utilising Advanced Fit Technology (AFT) into our silicone skirt to offer best fit and comfort for a wide range of faces. The buckle system integrates a pivoting technology providing two important benefits: structural stability and fit.



SINGLE LENS

Provides 180° distortion free vision

A·F·T

AFT: ADVANCED FIT TECHNOLOGY

provides a leak resistant seal



PIVOT BUCKLE STRAP SYSTEM

adjusts to the shape of your head

SILICONE COMFORTABLE SKIRT

for comfort and a better fit



LATEX FREE **MADE IN ITALY**

>>> OTHER FEATURES:

- quick fit buckle
- antiscratch
- hypoallergenic



>>> **MS5041201LMO** <<<
Orange Titanium Mirrored
VISTA PRO.A DGY BLK LMO



>>> **MS5040007LMS** <<<
Silver Titanium Mirrored
VISTA PRO.A CL/YLW LMS



>>> **MS5041208LMB** <<<
Indigo Titanium Mirrored
VISTA PRO.A DK GRY ORG LMB



>>> **MS5040001LMI** <<<
Iridescent Mirrored
VISTA PRO.A TRANSP BLK LMI

VISTA

ACTIVE

>>> Popular with Open Water Swimmers ready for a challenge, the Vista is a durable silicone mask made for unpredictable environments. Vista's low profile reduces the drag experienced with other swimming masks. With its soft silicone skirt, and quick fit buckle, you are ensured a comfortable, custom fit so you can focus on your swim, not your gear.



QUICK FIT BUCKLE

provides perfect fit & easy adjustments

SILICONE

COMFORTABLE SKIRT

assures leak resistant seal



LATEX FREE **MADE IN ITALY**



CURVED LENS GEOMETRY

for 180° wide peripheral vision

>>> **OTHER FEATURES:**

- distortion free vision
- antiscratch
- hypoallergenic



>>> **MS5050915LMR** <<<
Red Titanium Mirrored
 VISTA.A WHITE RED LMR

NEW



>>> **MS5051208LMB** <<<
Indigo Titanium Mirrored
 VISTA.A DK GRY ORG LMB



>>> **MS5050906LMI** <<<
Iridescent Mirrored
 VISTA.A WHT RED LMI



>>> **MS5050915LD** <<<
Smoke
 VISTA.A WHITE RED LD



>>> **MS5050916LD** <<<
Smoke
 VISTA.A WHITE RASPBERRY LD



>>> **MS5050012LD** <<<
Smoke
 VISTA.A TRP DGY LD



>>> **MS5050915LC** <<<
Clear
 VISTA.A WHITE RED LC



>>> **MS5050916LC** <<<
Clear
 VISTA.A WHITE RASPBERRY LC



>>> **MS5050012LC** <<<
Clear
 VISTA.A TRP DGY LC



>>> **MS5054340LC** <<<
Clear
 VISTA.A TBL BLU LC

VISTA XP

ACTIVE

>>> The Vista XP swimming mask is a call for adventure to all swimmers tempted by the experience of open water swimming or training for their first triathlon. This single Plexisol lens mask with its soft skirt offers broad distortion-free vision while being quick to put on thanks to its Quick Fit buckle. Even if your goal is about your well-being and fitness, a simple but high-quality mask is where to start the adventure confidently.

SOFTERIL
ULTRA SOFT SKIRT
for maximum comfort

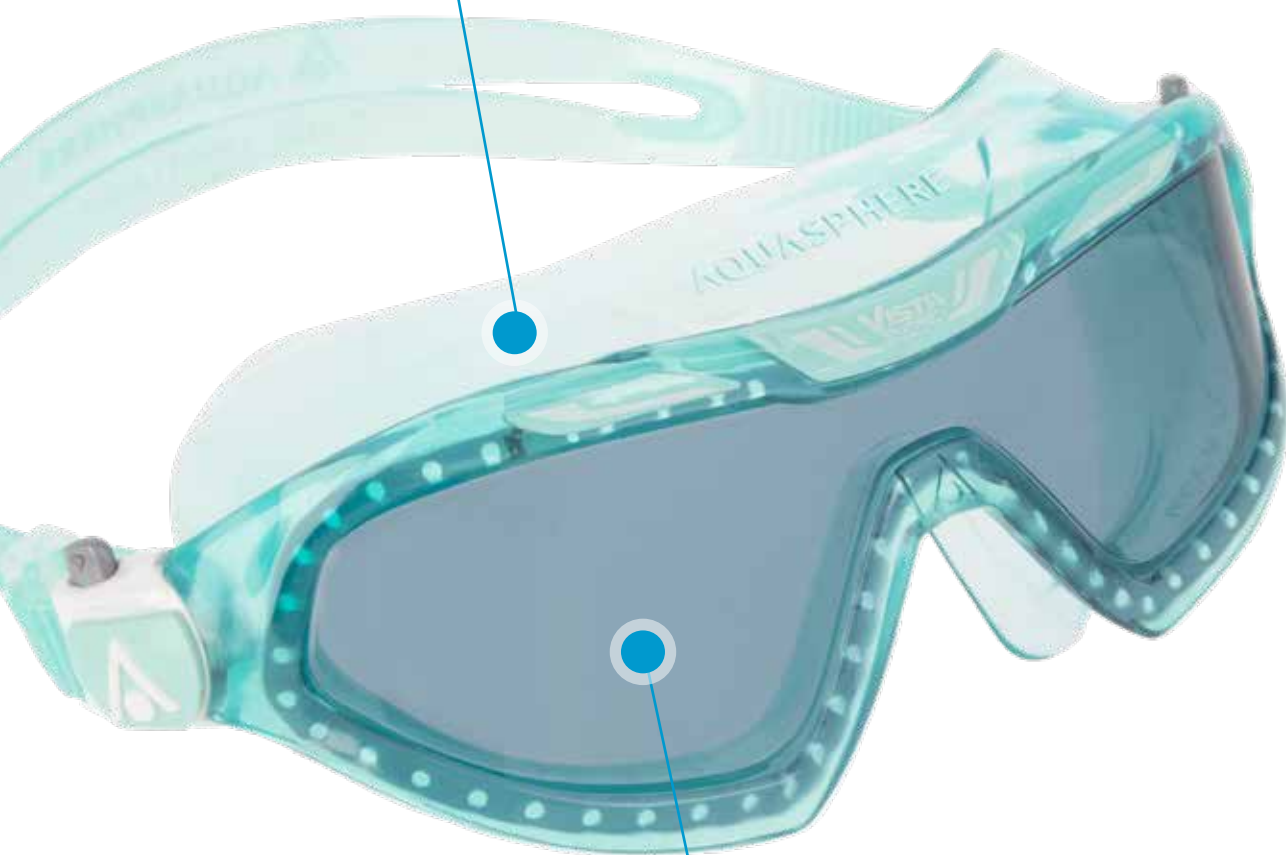

SINGLE LENS
provides 180° distortion free vision



LATEX FREE **MADE IN ITALY**

>>> **OTHER FEATURES:**

- antiscratch
- hypoallergenic
- softeril contains TPR



>>> **MS5090001LD** <<<

Smoke

VISTA X.P.A. TRANSP BLACK LD



>>> **MS5093535LD** <<<

Smoke

VISTA X.P.A. TINTED GREEN LD



>>> **MS5094009LC** <<<

Clear

VISTA X.P.A. BLUE WHITE LC



>>> **MS5090006LC** <<<

Clear

VISTA X.P.A. TRANSPARENT RED LC



>>> **MS5093535LC** <<<

Clear

VISTA X.P.A. TINTED GREEN LC

KAYENNE PRO

PERFORMANCE

>>> The Kayenne Pro, featuring an adjustable nose bridge with 4 interchangeable sizes and a superior fitting AFT leak-resistant seal, is perfect for any triathlete looking to up their game. Keep markers in sight using Curved Lens Geometry technology and our oversized Plexisol lens for an exceptional 180° wide peripheral vision with increased upper visibility. Start every race with confidence thanks to the high performance ultra-light frame and a Quick Fit Buckle.



ADJUSTABLE NOSE BRIDGE
with 4 interchangeable size options for a perfect fit

A·F·T

AFT: ADVANCED FIT TECHNOLOGY
provides a leak resistant seal



QUICKFIT BUCKLE
provides perfect fit & easy adjustments



CURVED LENS GEOMETRY
for 180° wide peripheral vision



LATEX FREE **MADE IN ITALY**

>>> OTHER FEATURES:

- ultra soft softeril skirt: for maximum comfort, softeril contains TPR
- oversized plexisol lens: increase upper visibility
- wide gasket: improve stability
- antiscratch
- hypoallergenic



>>> **EP3040910LP** <<<
Brown Polarized
 KAYENNE PRO.A WHT GRY LPB



>>> **EP3040910LPH** <<<
Photochromatic
 KAYENNE PRO.A WHT GRY LPH



NEW

>>> **EP3040171LPH** <<<
Photochromatic
 KAYENNE PRO.A BLK BR. YLW LPH



>>> **EP3040707LMY** <<<
Yellow Titanium Mirrored
 KAYENNE PRO.A YLW YLW LMY



>>> **EP3040010LMS** <<<
Silver Titanium Mirrored
 KAYENNE PRO.A TRASP/GRY LMS



>>> **EP3040010LMI** <<<
Iridescent Mirrored
 KAYENNE PRO.A TRANSP GRY LMI



>>> **EP3040707LD** <<<
Smoke
 KAYENNE PRO.A YLW YLW LD



>>> **EP3040010LD** <<<
Smoke
 KAYENNE PRO.A TRASP/GRY LD



>>> **EP3040010LC** <<<
Clear
 KAYENNE PRO.A TRASP/GRY LC

KAYENNE

ACTIVE

>>> Whether you're racing or training, the Kayenne is designed to help you reach your goals in the water using a unique, oversized lens design with expanded vision and a low-profile micro-frame. Save valuable seconds with our Quick Fit Buckle offering easy one-touch strap adjustments, and guarantee your perfect position thanks to the Stabilising BiMaterial Nose Bridge for a secure and comfortable fit.



STABILIZING BIMATERIAL NOSE BRIDGE
provides a secure and comfortable fit

SOFTERIL SKIRT
for comfort and leak resistant seal



QUICK FIT BUCKLE
offers easy onetouch strap adjustments



LATEX FREE



MADE IN ITALY

>>> **OTHER FEATURES:**

- distortion free vision
- antiscratch
- hypoallergenic
- softeril contains TPR



>>> **EP2960098LP** <<<

Brown Polarized

KAYENNE.A TR/SILVER/PETR LPB



>>> **EP2961008LPB** <<<

Brown Polarized

KAYENNE.A GRY ORG LPB



NEW

>>> **EP2961203LPH** <<<

Photochromatic

KAYENNE.A DK GRY GRN LPH



>>> **EP2961006LMR** <<<

Red Titanium Mirrored

KAYENNE.A GREY RED LMR



>>> **EP2961006LMS** <<<

Silver Titanium Mirrored

KAYENNE.A GREY RED LMS



>>> **EP2961006LMI** <<<

Iridescent Mirrored

KAYENNE.A GRY RED LMI



>>> **EP2960115LD** <<<

Smoke

KAYENNE.A BLK SLV LD



>>> **EP2960098LD** <<<

Smoke

KAYENNE.A TR/SILVER/PETR LD



>>> **EP2961006LD** <<<

Smoke

KAYENNE.A GREY RED LD



>>> **EP2960115LC** <<<

Clear

KAYENNE.A BLK SLV LC



>>> **EP2960098LC** <<<

Clear

KAYENNE.A TR/SILVER/PETR LC



>>> **EP2960001LC** <<<

Clear

KAYENNE.A TRP BLK LC

KAYENNE COMPACT

ACTIVE

>>> With its unique, oversized lens design, the Kayenne combines expanded 4-point vision with superior hydrodynamics thanks to its low-profile micro-frame. It also features a stabilising bimaterial nose bridge, for a secure and comfortable fit.

This combination makes the Kayenne a perfect choice whether in a pool or open water.



SOFTERIL SKIRT
for comfort and leak resistant seal

COMPACT FIT
made for smaller faces

STABILIZING BIMATERIAL NOSE BRIDGE
provides a secure and comfortable fit

  **LATEX FREE** **MADE IN ITALY**

- >>> **OTHER FEATURES:**
- distortion free vision
 - antiscratch
 - hypoallergenic
 - softeril contains TPR



>>> **EP2970910LPB** <<<

Brown Polarized

KAYENNE SMALL.A WHT GRY LPB



>>> **EP2970016LD** <<<

Smoke

KAYENNE SMALL.A TRAN/RASP LD



>>> **EP2970016LC** <<<

Clear

KAYENNE SMALL.A TRAN/RASP LC

KAIMAN EXO

ACTIVE

>>> Building off the long-standing success of our bestselling Kaiman design, which has sold more than eight million units, the Kaiman EXO incorporates first-of-its kind EXO-core bi-material frame technology that combines maximum stability with comfort. The Kaiman EXO is the perfect for the everyday swimmer looking to maximize comfort and durability.



**EXO
CORE**

EXO CORE TECHNOLOGY
provides stability and allows for a great fit



**EZ ADJUST BUCKLES WITH
SILICONE SPLIT STRAP**

for quick and easy fit adjustments



LATEX FREE **MADE IN ITALY**

>>> **OTHER FEATURES:**

- ultra soft softeril skirt: for maximum comfort, softeril contains TPR
- antiscratch
- hypoallergenic



>>> **EP2989800LMS** <<<

Silver Titanium Mirrored

KAIMAN EXO.A PETR/TRANSP LMS



>>> **EP2989800LD** <<<

Smoke

KAIMAN EXO.A PETR/TRANSP LD



>>> **EP2989800LC** <<<

Clear

KAIMAN EXO.A PETR/TRANSP LC

XCEED

PERFORMANCE

>>> The XCEED combines curved lens technology and a hydrodynamic low profile fit to give swimmers a competitive edge in perfect clarity. Featuring Exo-Core technology, for maximum comfort, stability and flexibility, the XCEED is a popular Racing and Training partner of many competitive swimmers.



ADJUSTABLE NOSE BRIDGE
with 4 interchangeable size options for a perfect fit

EXO CORE

TECHNOLOGY
provides stability and great hydrodynamics



CURVED LENS GEOMETRY
for 180° wide peripheral vision

SOFTERIL
ULTRA SOFT SKIRT
for maximum comfort



LATEX FREE **MADE IN ITALY**



>>> OTHER FEATURES:

- distortion free vision
- antiscratch
- hypoallergenic
- softeril contains TPR



>>> **EP3037104LMY** <<<

Yellow Titanium Mirrored

XCEED.A BRIGHT YLW NVY LMY



>>> **EP3030101LMY** <<<

Yellow Titanium Mirrored

XCEED.A BLK BLK BLK LMY



>>> **EP3030404LMB** <<<

Blue Titanium Mirrored

XCEED.A NVY NVY LMB



>>> **EP3030101LMR** <<<

Red Titanium Mirrored

XCEED.A BLK BLK BLK LMR



>>> **EP3030101LMP** <<<

Pink Titanium Mirrored

XCEED.A BLK BLK BLK LMP



>>> **EP3030109LMS** <<<

Silver Titanium Mirrored

XCEED.A BLK BLK WHT LMS



>>> **EP3030109LD** <<<

Smoke

XCEED.A BLK BLK WHT LD

NINJA

PERFORMANCE

>>> The revolutionary Ninja goggle combines a frame technology and a hydrodynamic low profile fit offering giving swimmers a competitive edge with the light weight, streamlined goggle. Utilising latest technologies, we have incorporated Advanced Fit Technology (AFT) into the softeril skirt to offer best fit and comfort. The patented Race Fit System offers swimmers a hassle-free experience so they can simply set the strap once and focus on swimming fast.

**EXO
CORE
TECHNOLOGY**
for ultimate hydrodynamics



**ADJUSTABLE
NOSE BRIDGE**
*with 4 interchangeable size
options for a perfect fit*

A·F·T
**ADVANCED FIT
TECHNOLOGY**
provides a leak resistant seal

R·F·S
RACE FIT SYSTEM
for customizable fit



**LATEX
FREE**

**MADE IN
ITALY**



>>> OTHER FEATURES:

- distortion free vision
- ultra soft softeril skirt: for maximum comfort, softeril contains TPR
- antiscratch
- hypoallergenic



>>> **EP3020101LMY** <<<

Yellow Titanium Mirrored
NINJA.A BLACK BLACK LMY



>>> **EP3020404LMB** <<<

Blue Titanium Mirrored
NINJA.A NAVY NAVY LMB



>>> **EP3020109LMS** <<<

Silver Titanium Mirrored
NINJA.A BLACK WHITE LMS

FASTLANE

ACTIVE

>>> The Fastlane goggle has an asymmetrical, anatomical design, and when paired with the soft silicone skirt offers a natural, comfortable, watertight fit. The Strap Management System offers quick hassle-free strap adjustments plus four nose bridge options ensuring a perfect fit. This is a perfect goggle for your everyday training needs.



SILICONE

ULTRA SOFT INNEREYE GASKET

assures comfort and leak resistant seal



STABLE STRAP SYSTEM

offers quick adjustments



ADJUSTABLE NOSE BRIDGE

with 4 interchangeable size options for a perfect fit



LATEX FREE



>>> **OTHER FEATURES:**

- antiscratch
- hypoallergenic



>>> **EP2990907LMY** <<<
Yellow Titanium Mirrored
 FASTLANE.A WHITE YELLOW LMY



>>> **EP2994009LMB** <<<
Blue Titanium Mirrored
 FASTLANE.A BLUE WHITE LMB



>>> **EP2990243LMP** <<<
Pink Titanium Mirrored
 FASTLANE.A PINK TURQUOISE LMP



>>> **EP2990406LMR** <<<
Red Titanium Mirrored
 FASTLANE.A NAVY BLUE RED LMR



>>> **EP2990910LMS** <<<
Silver Titanium Mirrored
 FASTLANE.A WHITE GREY LMS



>>> **EP2999898LD** <<<
Smoke
 FASTLANE.A PETROL PETROL LD



>>> **EP2990471LC** <<<
Clear
 FASTLANE.A NAVY BRIGHT YLW LC

SEAL 2.0

ACTIVE

>>> The Seal 2.0 is a direct descendant of our original swim mask, the Seal, and is the perfect swim mask for fitness swimmers. With its large format wrap-around lens design, the Seal offers a wide field of vision and the soft silicone facial skirt integrates Aquasphere's Advanced Fit Technology for a comfortable, watertight fit.

A·F·T

AFT: ADVANCED FIT TECHNOLOGY

provides a leak resistant seal

SILICONE

COMFORTABLE SKIRT

fits a wide variety of faces for maximum comfort



EZ ADJUST BUCKLES WITH SILICONE SPLIT STRAP

for quick and easy fit adjustments



LATEX FREE **MADE IN ITALY**

>>> **OTHER FEATURES:**

- distortion free vision
- antiscratch
- hypoallergenic



>>> **MS5070103LD** <<<

Smoke

SEAL 2.0.A BLK GRN LD



>>> **MS5073535LD** <<<

Smoke

SEAL 2.0.A TINTED GREEN LD



>>> **MS5074109LC** <<<

Clear

SEAL 2.0.A LBL WHT LC



>>> **MS5070110LC** <<<

Clear

SEAL 2.0.A BLK GRY LC



>>> **MS5073535LC** <<<

Clear

SEAL 2.0.A TINTED GREEN LC



EAGLE

ACTIVE

>>> Eagle Swim Goggles come with polycarbonate interchangeable lenses that you can easily swap out for custom corrective vision. Utilizing a unique construction of a one-piece silicone skirt and nose bridge frame combined with interchangeable lens retainer allows swimmers to purchase right and left high grade optical lenses to meet their specific vision.



>>> **EP3060000LC** <<<
Clear
EAGLE.A TRP TRP LC



>>> **EP3064400LC** <<<
Clear
EAGLE.A DBL TRP LC



>>> **EP3100000N*** <<<
Clear
OPTICAL LENS T EAGLE

SILICONE SKIRT

for comfort and leak resistant seal



EZ ADJUST BUCKLES WITH SILICONE SPLIT STRAP

for quick and easy fit adjustments

>>> Lenses come in half-step increments from -1.5 to -6.0 to match individual strengths for each eye.

Sold separately.

-1.5	EP3100000N15
-2.0	EP3100000N20
-2.5	EP3100000N25
-3.0	EP3100000N30
-3.5	EP3100000N35
-4.0	EP3100000N40
-4.5	EP3100000N45
-5.0	EP3100000N50
-5.5	EP3100000N55
-6.0	EP3100000N60



>>> OTHER FEATURES:

- antiscratch
- hypoallergenic

KAIMAN

ACTIVE

>>> Our original first curved lens goggle, bringing 180-degree vision to active swimmers. The Kaiman was designed with comfort and fit in mind, featuring our proprietary Softeril material and easy adjust side buckles.

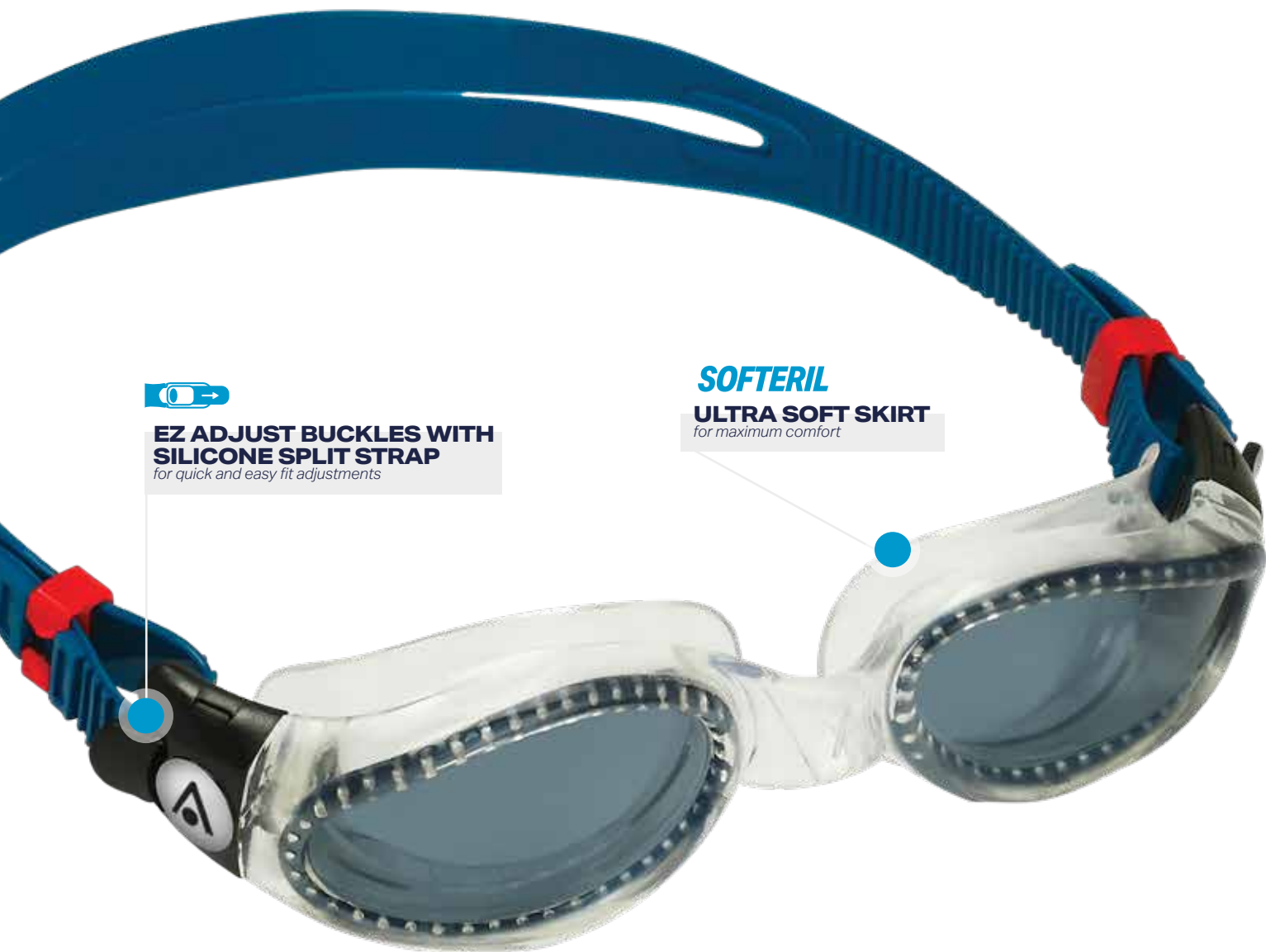

EZ ADJUST BUCKLES WITH SILICONE SPLIT STRAP
for quick and easy fit adjustments

SOFTERIL
ULTRA SOFT SKIRT
for maximum comfort



LATEX FREE **MADE IN ITALY**

>>> **OTHER FEATURES:**

- antiscratch
- hypoallergenic
- softeril contains TPR



>>> **EP3000098LMS** <<<

Silver Titanium Mirrored
KAIMAN.A CLEAR PETROL LMS



>>> **EP3000101LMS** <<<

Silver Titanium Mirrored
KAIMAN.A BLK BLK LMS



>>> **EP3000000LD** <<<

Smoke
KAIMAN.A TRP TRP LD



>>> **EP3000098LD** <<<

Smoke
KAIMAN.A CLEAR PETROL LD



>>> **EP3000101LD** <<<

Smoke
KAIMAN.A BLK BLK LD



>>> **EP3000000LB** <<<

Blue Tinted
KAIMAN.A TRP TRP LB



>>> **EP3000098LC** <<<

Clear
KAIMAN.A CLEAR PETROL LC



>>> **EP3000101LC** <<<

Clear
KAIMAN.A BLK BLK LC



>>> **EP3000000LC** <<<

Clear
KAIMAN.A TRP TRP LC



>>> **EP3004100LC** <<<

Clear
KAIMAN.A LBL TRP LC

KAIMAN COMPACT

ACTIVE

>>> Our original first curved lens goggle, bringing 180-degree vision to active swimmers. The Kaiman was designed with comfort and fit in mind, featuring our proprietary Softeril material and easy adjust side buckles.



SOFTERIL
ULTRA SOFT SKIRT
for maximum comfort



EZ ADJUST BUCKLES WITH SILICONE SPLIT STRAP
for quick and easy fit adjustments



COMPACT FIT
made for smaller faces



LATEX FREE **MADE IN ITALY**

>>> **OTHER FEATURES:**

- antiscratch
- hypoallergenic
- softeril contains TPR



>>> **EP3070101LD** <<<

Smoke

KAIMAN SMALL.A BLK BLK LD



>>> **EP3070000LD** <<<

Smoke

KAIMAN SMALL.A TRP TRP LD



>>> **EP3070000LB** <<<

Blue Tinted

KAIMAN SMALL.A TRP TRP LB



>>> **EP3070101LC** <<<

Clear

KAIMAN SMALL.A BLK BLK LC



>>> **EP3070043LC** <<<

Clear

KAIMAN SMALL.A TRP TBL LC

VISTA JR

JUNIOR

>>> Designed for aged 6+. The Vista Jr fits like a mask by sealing around the outside of the eyes, eliminating any pressure on the eye sockets. This creates a more Comfortable, Leak Free Fit so your kids can wear them all day without worrying about getting water in their eyes.

Incorporating our curved lens technology to offer a wide field of vision to give a very open, unrestricted feel that will boost your kids confidence in the water. Our Quick-Fit Buckle System makes adjusting the Vista Jr head strap easy.



6+

FIT
ages 6+

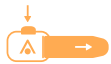

QUICK FIT BUCKLE
provides perfect fit & easy adjustments

SOFTERIL

ULTRA SOFT SKIRT
allows maximum comfort & leak resistant seal



LATEX FREE **MADE IN ITALY**

>>> **OTHER FEATURES:**

- antiscratch
- hypoallergenic
- softeril contains TPR



>>> **MS5080209LB** <<<
Blue Tinted
 VISTA JR.A PK WHT LB



>>> **MS5080031LB** <<<
Blue Tinted
 VISTA JR.A TRP BGN LB



>>> **MS5084008LC** <<<
Clear
 VISTA JR.A BLU ORG LC



>>> **MS5084007LC** <<<
Clear
 VISTA JUNIOR.A BLU YLW LC



>>> **MS5084302LC** <<<
Clear
 VISTA JUNIOR.A TRQ PNK LC

SEAL KID 2

JUNIOR

>>> The evolution of the original swim mask for children, the Seal Kid 2 delivers a leak-free fit for children as young as 3 years old. The Seal Kid 2 utilizes Aquasphere curved lenses technology for a wide field of vision, making children more confident in the water. The easy-adjust side buckles are simple for kids or parents to adjust even while wearing!



SOFTERIL

ULTRA SOFT SKIRT

allows maximum comfort & leak resistant seal

3+

FIT
ages 3+



LATEX FREE **MADE IN ITALY**

>>> OTHER FEATURES:

- torsion-free inserts
- antiscratch
- hypoallergenic
- softeril contains TPR



>>> **MS5060000LB** <<<

Blue Tinted

SEAL KID2 '18.A TRP TRP LB



>>> **MS5064002LC** <<<

Clear

SEAL KID2 '18.A BLUE PINK LC



>>> **MS5064340LC** <<<

Clear

SEAL KID2 '18.A TURQ BLUE LC



>>> **MS5063131LC** <<<

Clear

SEAL KID2 '18.A BGN BGN LC



>>> **MS5064343LC** <<<

Clear

SEAL KID2 '18.A TBL TBL LC



>>> **MS5060505LC** <<<

Clear

SEAL KID2 '18.A PRP PRP LC



>>> **MS5060202LC** <<<

Clear

SEAL KID2 '18.A PK PK LC

KAYENNE JR

JUNIOR

>>> Designed for ages 6-15. The Kayenne Jnr has unique oversized lens design and softeril skirt to combine for a comfortable leak free fit. Quick fit buckles make for easy one touch strap adjustments, even when wearing them!



SOFTERIL
ULTRA SOFT SKIRT
for comfort and leak resistant seal

6y+
FIT
ages 6+

EZ ADJUST BUCKLES WITH SILICONE SPLIT STRAP
for quick and easy fit adjustments

 **LATEX FREE** **MADE IN ITALY**

>>> **OTHER FEATURES:**

- antiscratch
- hypoallergenic
- softeril contains TPR



>>> **EP3014009LD** <<<
Smoke
 KAYENNE JR.A BLU WHITE LD



>>> **EP3010043LB** <<<
Blue Tinted
 KAYENNE JR.A TRANSP AQUA LB



>>> **EP3014007LC** <<<
Clear
 KAYENNE JR.A BLU YELLOW LC



>>> **EP3014302LC** <<<
Clear
 KAYENNE JR.A AQUA PINK LC



>>> **EP3010131LC** <<<
Clear
 KAYENNE JR.A BLK BGN LC



>>> **EP3010209LC** <<<
Clear
 KAYENNE JR.A PK WHT LC

WETSUITS

advanced
technology



Innovative mix of performance and long-lasting comfort, we aim to provide triathletes and open water swimmers the best training and race wetsuits.

PATRICK LANGE



MATERIALS

YAMAMOTO

Durable, lightweight, high-performance Japanese neoprene feels like a second skin thanks to maximum elasticity and thermal insulation.



YAMAMOTO 38

A more compressive version of the Japanese Yamamoto neoprene contours to your body in areas with smaller motion ranges.



YAMAMOTO 39

The high-elasticity version of Yamamoto neoprene offers a greater range of motion to reduce muscle fatigue while swimming.



YAMAMOTO 40

The latest generation of Japanese neoprene features improved flexibility for an unlimited range of motion.



Bio Stretch Zones

2-way stretch for an unlimited and uncompromised range of motion in the water.



Super Composite Skin

Hydrophobic coating to reduce surface drag for more speed in the water and during transitions.



TECHNOLOGIES



QUICK RELEASE PANELS

Increased mid-calf openings make your suit easier to get off for faster transition times.



AERODOME TECHNOLOGY

Retain water bubbles in air pockets to boost buoyancy and save energy.

2.0
AQUAFLEX

AQUAFLEX 2.0

Dual-sided SCS neoprene collar to limit water entry and avoid neck chafing. More comfortable than ever.



THERMO GUARD

More warmth for more time spent at the top of your game.

RACER.Boost

PERFORMANCE



>>> Feel the difference and save energy during your race with our best in class triathlon wetsuit, the RACER.Boost. Strategically placed Aerodome Technology provides extra boost of buoyancy for better horizontal positioning in the water and the latest generation of Yamamoto 40 neoprene improves flexibility in the shoulders and back to reduce muscle fatigue. Experience ultimate comfort with the new Aquaflex 2.0 anti-chafe collar, faster transitions with Quick Release Panels and reduced water drag with our SCS Coating.



YAMAMOTO

- 4MM - #39
- 3.5MM - #39
- 3.5MM - AERODOME
- 2MM - #40
- 1,5MM - #40
- LYCRA FABRIC



OTHER FEATURES

- SCS Coating: reduced drag and water absorption, greater water glide & increased speed
- Thermo Guard: neoprene panels on chest, shoulders and legs, maintains body heat
- Reversed back zipper: top to bottom for easy removal

NEW



MEN

>>> **SU0100173** <<<
BLACK & LIME
 XS / S / M / ML / L / XL / 2XL

NEW



WOMEN

>>> **SU0110173** <<<
BLACK & LIME
 2XS / XS / S / M / L / XL

RACER.**Boost** Shorts

PERFORMANCE

>>> Feel the difference in your next training session and lift your swim with a new Adjustable Waistband featuring flat lace to prevent water entry and Thermo Guard technology for warmth and protection. The RACER.BOOST helps you save energy and maximise performance by keeping you horizontal in the water and reducing drag thanks to Aerodome Technology and a Super Composite Skin Coating.

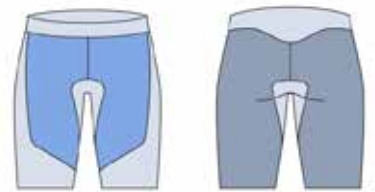

YAMAMOTO

- 4,5MM - AERODOME
- 3MM - #38
- 2MM - #38

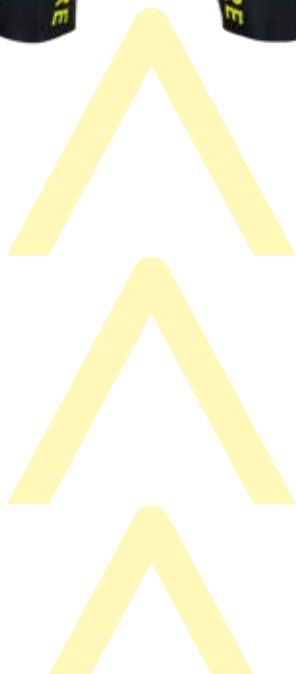

NEW

UNISEX

>>> **SU0260173** <<<
BLACK & LIME
 XS / S / M / L / XL



RACER.Flex

PERFORMANCE



2.0 AQUAFLEX

SCS neoprene double sided collar
Maximizes comfort
Prevents chaffing



39
XX

40
XX

Bio stretch zones & Yamamoto 40

Maximizes flexibility
Increase range of motion
Reduced fatigue

SCS COATING

SCS Coating

Reduced drag and water absorption for a greater water glide



Quick release panel

Increased mid-calf opening
Easy off
Improved transition time

>>> Set off into your triathlon race with confidence in the RACER.Flex thanks to Bio Stretch Zones and Yamamoto 40 limestone neoprene in strategic area for maximum flexibility and reduced muscle fatigue. Using Thermo Guard technology to maintain body heat and a new Aquaflex 2.0 double-sided collar to prevent chafing means you can focus on your stroke in extreme comfort. The different panels thicknesses allow for ideal buoyancy and greater water glide. The RACER.Flex is the optimal wetsuit for any triathlete.



YAMAMOTO

- 5MM - #39
- 4MM - #39
- 3MM - #39
- 2MM - #39
- 1,5MM - #40

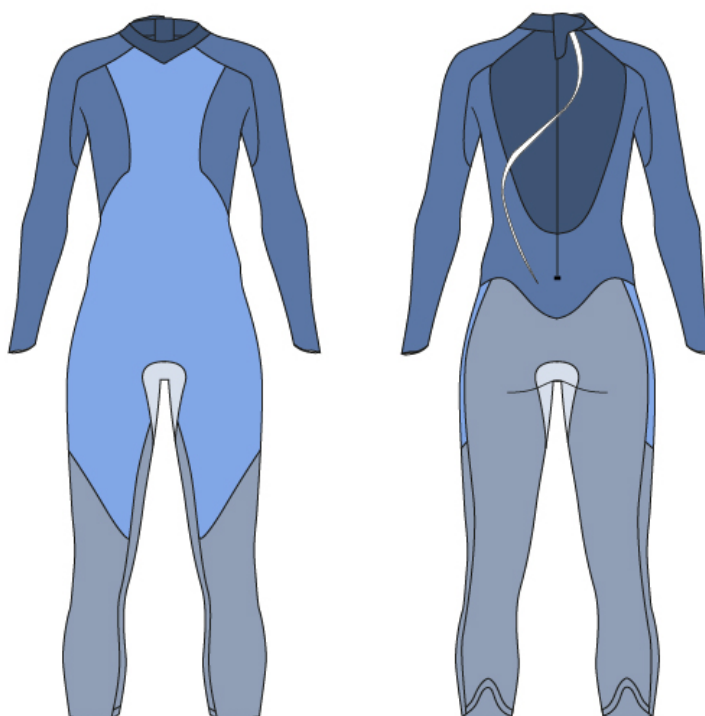

OTHER FEATURES

- Aquaflex 2.0: SCS neoprene double sided collar
- Thermo Guard: thick neoprene panels on chest, shoulders and legs to maintains body heat
- Regular back zipper: easy removal



NEW

MEN

>>> **SU0120131** <<<
BLACK & GREEN
 XS / S / M / ML / L / XL / 2XL



NEW

WOMEN

>>> **SU0130131** <<<
BLACK & GREEN
 2XS / XS / S / M / L / XL

RACER.Active

ACTIVE



2.0 AQUAFLEX

SCS neoprene double sided collar
Maximizes comfort
Prevents chaffing



Bio stretch zones

Maximizes flexibility
Increase range of motion
Reduced fatigue

38 XX

Yamamoto 38

4mm neoprene panels on chest and thighs
Increased buoyancy & reduced drag

>>> The RACER.Active is designed to fit you better thanks to 2mm Bio Stretch Zones in critical areas for freedom of movement and more compressive Yamamoto 38 neoprene for extra support where you need it most. Our new and improved Aquaflex 2.0 double-sided collar is our comfiest anti-chafe neck seal yet, while the Thermo Guard panels help you maintain your body temperature so you can stay in the water for longer. Training for your next triathlon has never felt better.



YAMAMOTO

- 4MM - #38
- 3,5MM - #38
- 3MM - #38
- 2MM - #38
- 2MM - #39
- 1,5MM - #38



OTHER FEATURES

- SCS Coating: reduced drag & water absorption, greater water glide
- Thermo Guard: thick neoprene panels on chest, shoulders and legs to maintains body heat
- Regular back zipper: easy removal
- Quick release panels: increased mid-calf opening, easy off



NEW

MEN

>>> **SU0220140** <<<
BLACK & BLUE
 XS / S / M / ML / L / XL / 2XL



NEW

WOMEN

>>> **SU0230140** <<<
BLACK & BLUE
 2XS / XS / S / M / L / XL

RACER.Swimrun

PERFORMANCE



Thermo Guard

3mm pannels on chest, shoulders and legs. Maintains body heat.

39
XX

Yamamoto 39

Maximized range of motion & reduced fatigue



Strategic storage pockets

2 zippers on the front
1 zipper at the back



Front and Back zipper opening

Velcro flap to protect neck from chaffing and water entry

>>> The innovative RACER.Swimrun Shorty features Yamamoto 39 Japanese neoprene for a maximised range of motion and reduced fatigue, while the printed back thigh panels ensure durability and protection. Take your training and competitions to the next level with easy-access strategic storage pockets for energy snacks, front and back zip openings, including an anti-chafe collar and woven loops for safety buoys or other accessories.



YAMAMOTO

- 4MM - #39
- 3MM - #39
- 2MM - #39
- 1,5MM - #39



OTHER FEATURES

- Side thigh panels 3,5mm: additional buoyancy
- Printed back thigh panels: protect and prevent from tear and enhanced durability
- Woven loop on waist and back: secure tie for buoy, pull buoy and accessories
- Front zipper: whistle attached to the puller



MEN

>>> **SU0080173** <<<

BLACK & LIME

XS / S / M / L / XL / 2XL



WOMEN

>>> **SU0090173** <<<

BLACK & LIME

XS / S / M / L / XL

Aquaskin Full suit

ACTIVE



**SCS
COATING**

SCS Coating

SCS Neoprene 1,5mm
Maximum flexibility & reduced
drag and water absorption

>>> Extend the length of your stroke and increase your speed in the water with 1.5mm SCS Neoprene, designed to provide maximum flexibility where you need it most and reduced drag and water absorption. Experience lighter, warmer or more comfortable swim sessions with the AQUASKIN Full Suit, the perfect match for any open water swimmer.



OTHER FEATURES

- Glued & Blindstitched assembling: watertight seal
- Pull back zipper: easy on & off

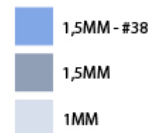
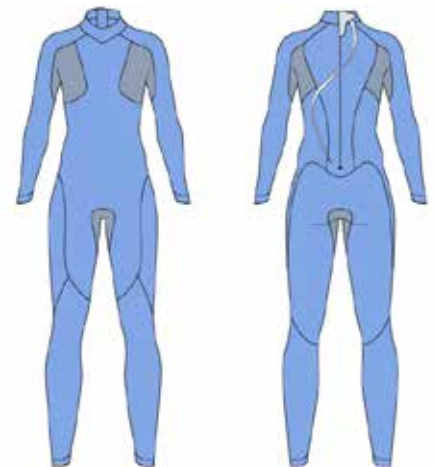

MEN



WOMEN

>>> **SU8400140** <<<
BLACK & BLUE
S / M / L / XL / 2XL

>>> **SU8410140** <<<
BLACK & BLUE
XS / S / M / L / XL

Aquaskin **Shorty**

ACTIVE



SCS
COATING

SCS Coating

SCS Neoprene 1,5mm
Maximum flexibility & reduced
drag and water absorption

>>> Maximise your time in the water and boost your training sessions with 1.5mm SCS Neoprene for maximum flexibility. Thanks to watertight glued and blind stitched seams, the easy on-and-off back zip AQUASKIN Shorty is the perfect match for any open water swimmer.



OTHER FEATURES

- *Glued & Blindstitched assembling: watertight seal*
- *Pull back zipper: easy on & off*

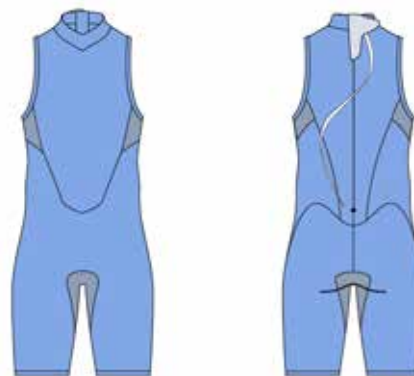

MEN

>>> **SU8520140** <<<
BLACK & BLUE
S / M / L / XL / 2XL



WOMEN

>>> **SU8510140** <<<
BLACK & BLUE
XS / S / M / L / XL

Aquaskin **Top**

ACTIVE



The long sleeve AQUASKIN Top features a Hybrid Construction, with ultra-thin 0.5mm neoprene panels on the body and polyester-spandex fabric on the shoulders and sleeves to provide complete rotational freedom with each stroke.



HYBRID CONSTRUCTION

0,5mm Neoprene on body and fabric on sleeve: protect and maintain heat



MEN

>>> **SU8430140** <<<

BLACK TURQUOISE
S/M/L/XL/2XL



WOMEN

>>> **SU8440140** <<<

BLACK TURQUOISE
XS/S/M/L/XL

Aquaskin **Hood**



S.C.S. COATING

Neoprene 2mm
Warmth & Comfort



>>> **SU8230140** <<<

BLACK & BLUE
S / M / L / XL

OTHER FEATURES

- Glued and blindstitched assembling

Stingray

JUNIOR



HYBRID CONSTRUCTION
 Neoprene and fabric (80%Nylon, 20% Spandex) panels



>>> **SJ4354204** <<<
ROYAL BLUE NAVY BLUE
 1/2/4/6/8/10/12



>>> **SJ4350204** <<<
PINK NAVY BLUE
 1/2/4/6/8/10/12



>>> **SJ4353104** <<<
BRIGHT GREEN NAVY BLUE
 1/2/4/6/8/10/12



>>> **SJ4344204** <<<
ROYAL BLUE NAVY BLUE
 1/2/4/6/8/10/12



>>> **SJ4340204** <<<
PINK NAVY BLUE
 1/2/4/6/8/10/12



>>> **SJ4343104** <<<
BRIGHT GREEN NAVY BLUE
 1/2/4/6/8/10/12

SIZING CHART

MEN

WETSUITS	HEIGHT (INCH/CM)	WEIGHT (LB/KG)
XS	59 - 65	121 - 143
	150 - 165	55 - 63
S	65 - 69	139 - 161
	165 - 175	63 - 73
M	68 - 73	155 - 175
	173 - 185	70 - 80
ML	70 - 75	165 - 198
	178 - 190	75 - 90
L	73 - 76	187 - 214
	185 - 195	85 - 97
XL	75 - 80	207 - 242
	190 - 205	94 - 110
2XL	78 +	242 +
	200+	110+

WOMEN

WETSUITS	HEIGHT (INCH/CM)	WEIGHT (LB/KG)
2XS	54 - 58	92 - 108
	137 - 147	42 - 49
XS	57 - 61	100 - 115
	145 - 155	45 - 52
S	61 - 65	110 - 125
	155 - 165	50 - 57
M	65 - 69	120 - 145
	165 - 175	54 - 64
L	68 - 73	140 - 165
	173 - 185	64 - 75
XL	73+	165+
	185+	75+

KIDS

STINGRAY	HEIGHT (INCH/CM)	WEIGHT (LB/KG)
1	30 - 32	19 - 24
	76 - 83	9 - 11
2	33 - 39	25 - 35
	84 - 99	11 - 16
4	40 - 44	35 - 45
	101 - 112	16 - 20
6	45 - 47	42 - 47
	114 - 119	19 - 22
8	48 - 50	47 - 54
	122 - 127	21 - 25
10	51 - 56	55 - 70
	130 - 142	25 - 32
12	55 - 60	73 - 84
	140 - 152	33 - 38



TECH SUITS

purposeful
innovations

Designed for the elite athletes,
our competitive tech suits feature
compressive support and exceptional
hydrodynamics.

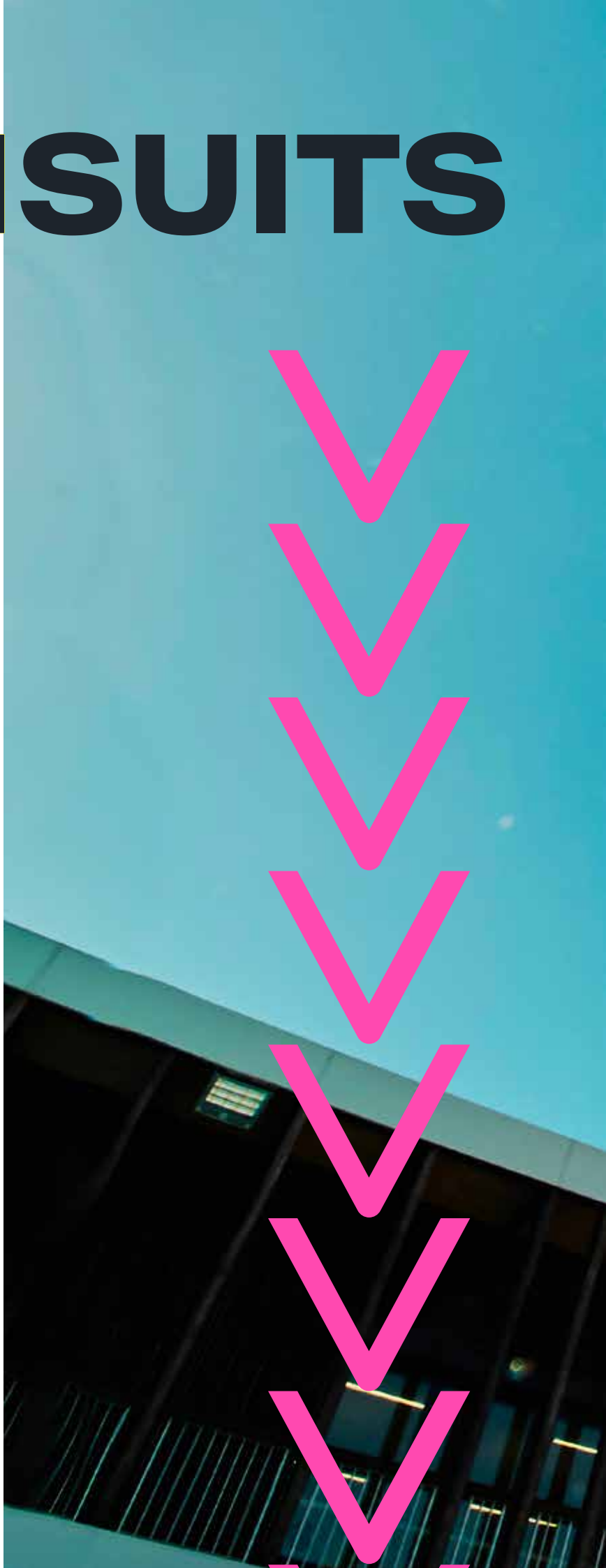



PENNY OLEKSIK

RACER.Speedsuit

PERFORMANCE

>>> Speed through the warm water like never before using a combination of hydrophobic fabric that decreases drag and reduces water absorption, jacquard fabric for more flexibility, and woven materials for compressive support when you need it most. Designed for the elite triathlete, the exceptionally hydrodynamic RACER.Speedsuit is engineered with Thermo-Bonded Seams to prevent chafing and an Auto-Lock Zipper with an easy release for super-fast, fuss-free transitions.



JACQUARD FABRIC

Increased flexibility



THERMO BOUNDED SEAMS

Prevents chaffing & maximize comfort



WOVEN FABRIC

Increased compression



HYDROPHOBIC FABRICS

Muscle vibrating control, reduced water absorption & drag



● JACQUARD fabric
● Woven fabric

OTHER FEATURES

- Auto Lock Zipper
- Back staydown puller: quick transition & easy release

NEW



MEN

>>> CM0130101 <<<<

BLACK

XS/S/M/ML/L/XL/2XL

NEW



WOMEN

>>> CW0180101 <<<<

BLACK

XS/S/M/L/XL

SIZING CHART

MEN

TECHSUITS	HEIGHT (INCH/CM)	WEIGHT (LB/KG)
XS	59 - 65	121 - 143
	150 - 165	55 - 63
S	65 - 69	139 - 161
	165 - 175	63 - 73
M	68 - 73	155 - 175
	173 - 185	70 - 80
ML	70 - 75	165 - 198
	178 - 190	75 - 90
L	73 - 76	187 - 214
	185 - 195	85 - 97
XL	75 - 80	207 - 242
	190 - 205	94 - 110
2XL	78 +	242 +
	200+	110+

WOMEN

TECHSUITS	HEIGHT (INCH/CM)	WEIGHT (LB/KG)
2XS	54 - 58	92 - 108
	137 - 147	42 - 49
XS	57 - 61	100 - 115
	145 - 155	45 - 52
S	61 - 65	110 - 125
	155 - 165	50 - 57
M	65 - 69	120 - 145
	165 - 175	54 - 64
L	68 - 73	140 - 165
	173 - 185	64 - 75
XL	73+	165+
	185+	75+

MATRIX

PERFORMANCE

The Matrix Tech Suit is a **top-of-the-line FINA** approved competitive tech suit created with propriety **Exo-Core technology**. *It features both adaptive compression material to reduce muscle vibration and drag while ensuring maximum flexibility and freedom of movement.* In addition, **the Matrix** includes a sustaining tape system for improved body position by utilizing front and back axis tape and **cross-coordinating to improve length and position.**



RESEARCH & DEVELOPMENT

>>> 5000 HOURS OF TESTING

- Full dedicated team of 6 athletes, coaches and scientists
- Tested on 100+ athletes
- Granada university of sport science & a tech team involved
- Made in Italy

>>> CORE FEATURES

- Exo core Technology – Greater compression and range of motion
- Combines 2 fabrics:
 - Adapted Compression: high level of compression and progressive stretch to control muscle vibration
 - Jacquard: reduce drag and maximize muscle flexibility

>>> SUSTAINING TAPE CAGE - IMPROVE LENGTH & BODY POSITION

- The structure that snaps back allows greater propulsion.
- Cross-coordinating front and back axis tape offers horizontal buoyancy.



SUSTAINING
TAPES SYSTEMS



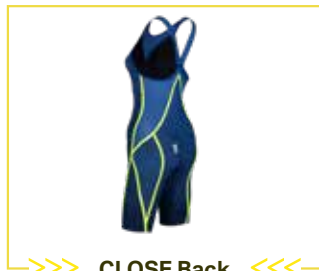

CLOSE Back

CW0150471

US: 26/28/30/32/34/36/38/40

CW0140471

EU: 26/28/30/32/34/36/38/40

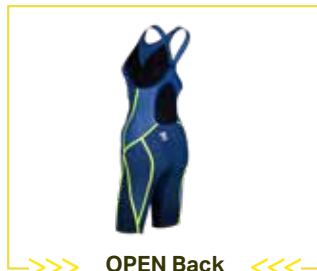

OPEN Back

CW0170471

US: 26/28/30/32/34/36/38/40

CW0160471

EU: 26/28/30/32/34/36/38/40



CLOSE Back

CW0150101

US: 26/28/30/32/34/36/38/40

CW0140101

EU: 26/28/30/32/34/36/38/40

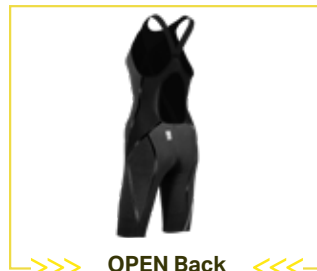

OPEN Back

CW0170101

US: 26/28/30/32/34/36/38/40

CW0160101

EU: 26/28/30/32/34/36/38/40



JACQUARD THREAD FABRIC

- Reduced drag
- 4-way stretch allows for maximum muscle flexibility
- 55% Polyamide / 45% Elastane

SUSTAINING TAPE CAGE

- Structure snaps back
- Greater propulsion
- Horizontal buoyancy

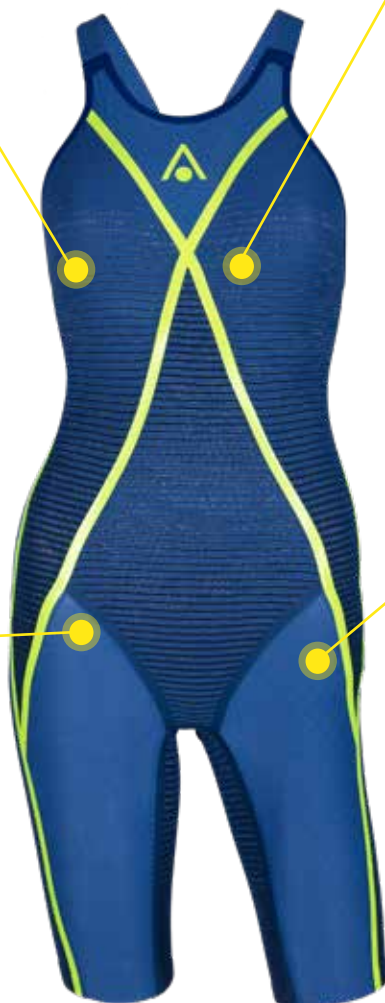

EXO CORE

EXO-CORE TECHNOLOGY

- Combination of the 2 fabrics
- Greater compression and range of motion

ADAPTED COMPRESSION PROGRESSIVE FABRIC

- Muscles vibrating control
- Striped fabric provides high level of compression and one-way progressive stretch (vertical)
- 53% Polyamide / 33% Elastane / 13% Polyester / 1% Metal

OTHER FEATURES

- Water repellent fabrics: reduce drag



HIGH Waist

CM0110471

50/55/60/65/70/75/80/85



LOW Waist

CM0120471

50/55/60/65/70/75/80/85

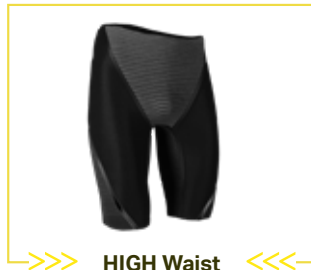

HIGH Waist

CM0110101

50/55/60/65/70/75/80/85



LOW Waist

CM0120101

50/55/60/65/70/75/80/85



JACQUARD THREAD FABRIC

- Reduced drag
- 4-way stretch allows for maximum muscle flexibility
- 55% Polyamide / 45% Elastane

ADAPTED COMPRESSION PROGRESSIVE FABRIC

- Muscles vibrating control
- Striped fabric provides high level of compression and one-way progressive stretch (vertical)
- 53% Polyamide / 33% Elastane / 13% Polyester / 1% Metal



EXO CORE

EXO-CORE TECHNOLOGY

- Combination of the 2 fabrics
- Greater compression and range of motion

SUSTAINING TAPE CAGE

- Structure snaps back
- Greater propulsion
- Horizontal buoyancy

OTHER FEATURES

- Water repellent fabrics: reduce drag

SIZING CHART

MEN

FR		50	55	60	65	70	75	80	85
UK / US		20	22	24	26	28	30	32	34
DE / A / CH		000	00	0	1	2	3	4	5
IT		34	36	38	40	42	44	46	48
WAIST	cm	26-27	27-28	28-29	29-30	30-31	31-32	32-33	33-34
	inches	66-69	69-71	71-74	74-76	76-79	79-81	81-84	84-87
HIPS	cm	30-32	32-33	33-34	34-36	36-38	38-39	39-40	40-41
	inches	78-82	82-84	84-87	87-92	92-97	97-99	99-102	102-104

WOMEN

FR		26	28	30	32	34	36	38	40
UK / US		20	22	24	26	28	30	32	34
DE / A / CH		24	26	28	30	32	34	36	38
IT		30	32	34	36	38	40	42	44
CHEST	cm	64-70	70-81	81-84	84-89	89-92	92-97	97-99	99-102
	inches	25-27	27-32	32-33	33-35	35-36	36-38	38-39	39-40
WAIST	cm	51-56	56-61	61-66	66-71	71-74	74-76	76-79	79-81
	inches	20-22	22-24	24-26	26-28	28-29	29-30	30-31	31-32
HIPS	cm	71-76	76-81	81-87	87-92	92-97	97-102	102-107	107-112
	inches	28-30	30-32	32-34	34-36	36-38	38-40	40-42	42-44
BODY LOOP	cm	135	140	145	150	155	160	165	170
	inches	53-54	55-56	57-58	59-60	61-62	63-64	65-66	67-68

NOTE: THIS CHART IS INTENDED TO BE USED AS A GENERAL SIZING GUIDELINE.

SWIMWEAR

insightful &
sustainable

Our swimwear chlorine-resistant and sustainable fabrics mixed to the right amount of stretch offers durability, functionality and comfort.







SWIMWEAR FABRICS

SUSTAINABILITY

We are proud to introduce two sustainable fabrics to our swimwear. All the Essential training suits are made from 2 to 5 plastic bottles!

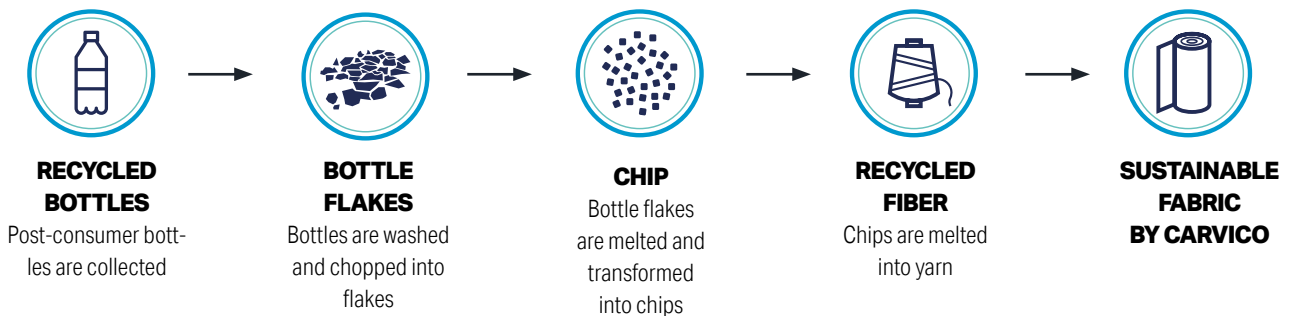

SUSTAINABLE FABRICS

51%
Recycled Polyester
+ 49%
P.B.T

SYDNEY ECO

Sydney Eco sustainable fabric is designed to last through any intense training of Elite athletes.

- chlorine proof
- recycled yarn
- shape retention
- pilling resistant
- two-way stretch
- breathable

AVAILABLE FOR:



78%
Recycled Polyester
+ 22%
ELASTOLEFIN

X-PLAY

X-Play sustainable fabric is designed to assure support and comfort during fitness swim training.

- chlorine proof
- recycled yarn
- four-way stretch
- breathable
- pilling resistant

AVAILABLE FOR:



BRIEF8CM

ESSENTIALS



100%
Chlorine resistant

FULLY LINED
Long-lasting comfort

>>> The Essential Brief 8cm has been designed to last through any intense training. Crafted with Sydney Eco sustainable fabric, it allows a compressive and breathable fit while guaranteeing long lasting comfort.

This training suit is made of 2 plastic bottles!*



NEW



>>> **SM4740107** <<<

BLACK & YELLOW

65/70/75/80/85/90/95

NEW

NEW



>>> **SM4749904** <<<

MULTICOLOR NAVY

65/70/75/80/85/90/95



>>> **SM4740403** <<<

NAVY & GREEN

65/70/75/80/85/90/95

OTHER FEATURES

- Durable Fabric Elasticity
- Sydney Eco composition:
51% Recycled Polyester from post-consumer recycled PET bottles + 49% polyester from PBT

* Based on 1L bottle and size 85

BRIEF 14CM

ESSENTIALS

>>> The Essential Brief 14cm has been designed to last through any intense training. Crafted with Sydney Eco sustainable fabric, it allows a compressive and breathable fit while guaranteeing long lasting comfort.

This training suit is made of 2 plastic bottles!*

- 
chlorine proof
- 
recycled yarn
- 
shape retention
- 
pilling resistant
- 
two-way stretch
- 
breathable



100%
Chlorine resistant

FULLY LINED
Long-lasting comfort

NEW



>>> **SM4770107** <<<

BLACK & YELLOW

65/70/75/80/85/90/95

NEW



>>> **SM4779904** <<<

MULTICOLOR NAVY

65/70/75/80/85/90/95

NEW

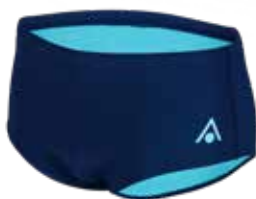

>>> **SM4770403** <<<

NAVY & GREEN

65/70/75/80/85/90/95

OTHER FEATURES

- Durable Fabric Elasticity
- Sydney Eco composition: 51% Recycled Polyester from post-consumer recycled PET bottles + 49% polyester from PBT

* Based on 1L bottle and size 85

BOXER

ESSENTIALS

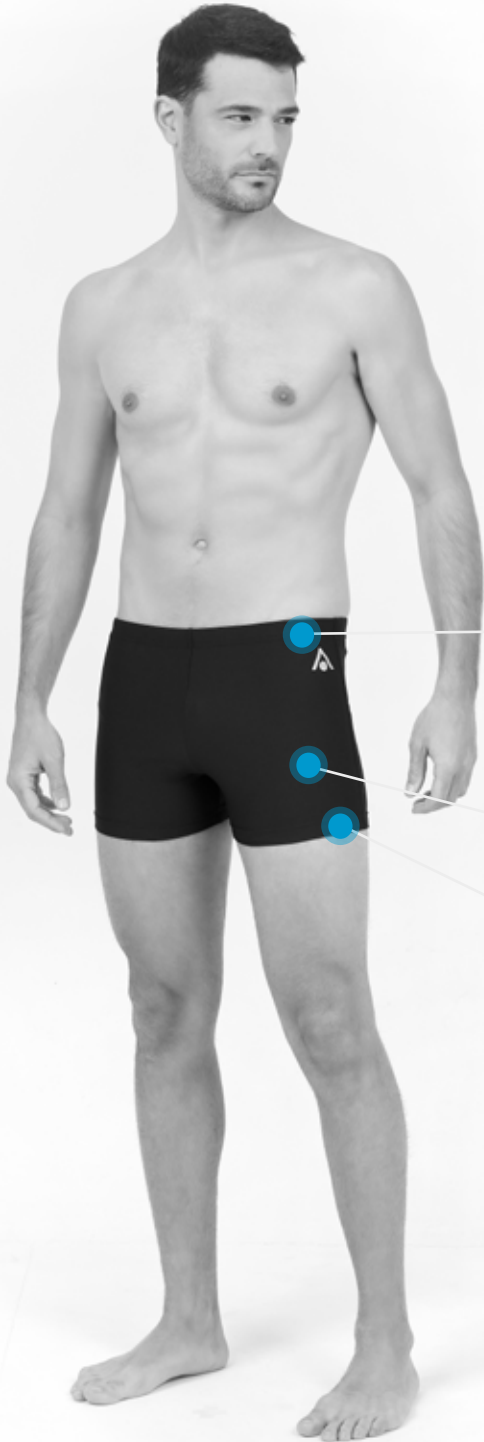

>>> The Essential Boxer has been designed to guarantee long lasting comfort during swim training. Crafted with X-Play sustainable fabric, it allows high flexible fit guaranteeing greater range of motion.

This training suit is made of 3 plastic bottles!*



100%
Chlorine resistant

FULLY LINED
Long-lasting comfort

INNER BRIEF



NEW

>>> **SM4750107** <<<

BLACK & YELLOW

65/70/75/80/85/90/95



NEW

>>> **SM4759904** <<<

MULTICOLOR NAVY

65/70/75/80/85/90/95



NEW

>>> **SM4750408** <<<

NAVY & ORANGE

65/70/75/80/85/90/95

OTHER FEATURES

- Durable Fabric Elasticity
 - X-Play composition: 78% Recycled Polyester (100% regenerated from PET plastic bottles) + 22 % Elastofin
- * Based on 1L bottle and size 85

JAMMER

ESSENTIALS

>>> The Essential Jammer has been designed to assure long lasting comfort during swim training. Crafted with X-Play sustainable fabric, it allows high flexible fit guaranteeing greater range of motion.

This training suit is made of 5 plastic bottles!*

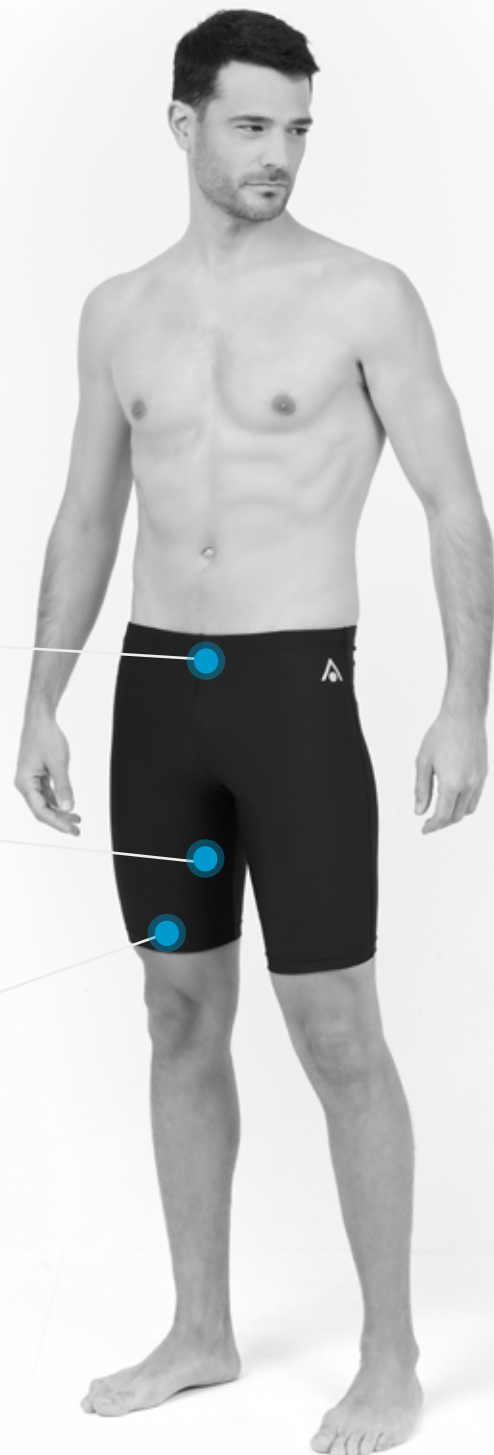

100%
Chlorine resistant

FULLY LINED
Long-lasting comfort

INNER BRIEF

NEW



>>> **SM4760107** <<<
BLACK & YELLOW
65/70/75/80/85/90/95

NEW



>>> **SM4769904** <<<
MULTICOLOR NAVY
65/70/75/80/85/90/95

NEW



>>> **SM4760408** <<<
NAVY & ORANGE
65/70/75/80/85/90/95

OTHER FEATURES

- Durable Fabric Elasticity
 - X-Play composition: 78% Recycled Polyester (100% regenerated from PET plastic bottles) + 22 % Elastolefin
- * Based on 1L bottle and size 85

TIEBACK

ESSENTIALS

>>> The Essential Tie Back has been designed to last through any intense training. Crafted with Sydney Eco sustainable fabric, it allows a compressive and breathable fit while guaranteeing long lasting comfort.

This training suit is made of 3 plastic bottles!*

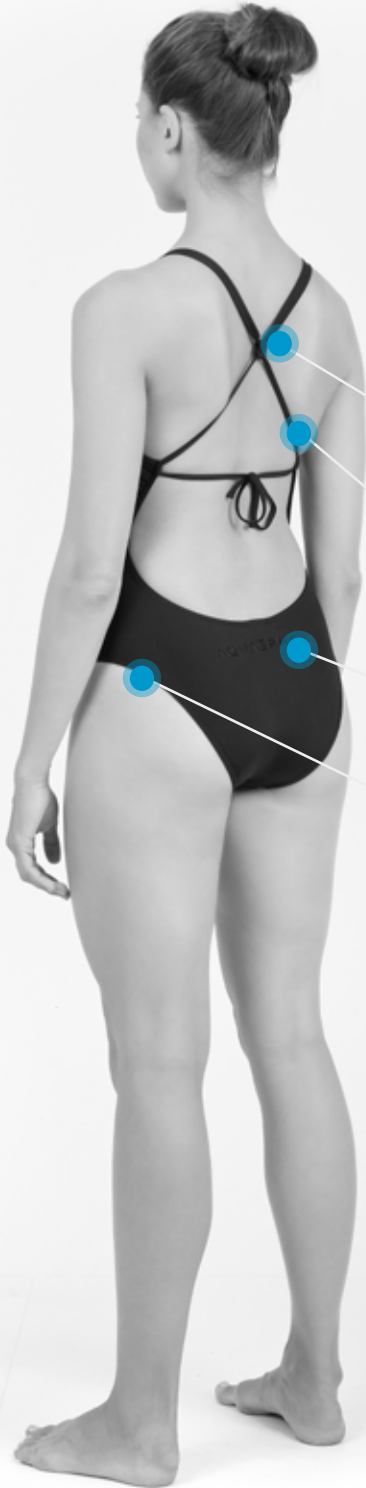

TIE BACK
Adjust chest fitting

DURABLE SILICONE STRAPS
Long-lasting comfort

100%
Chlorine resistant

HIGH-LEG CUT
Greater range of motion

OTHER FEATURES

- Durable Fabric Elasticity
 - Double lining
 - Sydney Eco composition:
51% Recycled Polyester from post-consumer recycled PET bottles + 49% polyester from PBT
- * Based on 1L bottle and size FR 36



NEW

>>> **SW4690107** <<<
BLACK & YELLOW
34/36/38/40/42/44/46/48



NEW

>>> **SW4690304** <<<
NAVY & GREEN
34/36/38/40/42/44/46/48



NEW

>>> **SW4699904** <<<
MULTICOLOR NAVY
34/36/38/40/42/44/46/48



NEW

>>> **SW4699908** <<<
MULTICOLOR ORANGE
34/36/38/40/42/44/46/48



PENNY OLEKSIK

WIDEBACK

ESSENTIALS

>>> The Essential Wide Back has been designed to assure long lasting comfort during swim training. Crafted with X-Play sustainable fabric, it allows high flexible fit guaranteeing greater range of motion.

This training suit is made of 4 plastic bottles!*



WIDE BACK
Better water sensation

THIN STRAPS
Long-lasting comfort

100%
Chlorine resistant

MIDDLE-LEG CUT
Greater coverage

OTHER FEATURES

- Durable Fabric Elasticity
- Double lining
- X-Play composition: 78% Recycled Polyester (100% regenerated from PET plastic bottles) + 22 % Elastolefin

* Based on 1L bottle and size 36



NEW

>>> **SW4660107** <<<

BLACK & YELLOW

34/36/38/40/42/44/46/48



NEW

>>> **SW4669904** <<<

MULTICOLOR NAVY

34/36/38/40/42/44/46/48



NEW

>>> **SW4660408** <<<

NAVY & ORANGE

34/36/38/40/42/44/46/48

FLYBACK

ESSENTIALS

>>> The Essential Fly Back has been designed to assure long lasting comfort during swim training. Crafted with X-Play sustainable fabric, it allows high flexible fit guaranteeing greater range of motion.

This training suit is made of 4 plastic bottles!*

- 
chlorine proof
- 
recycled yarn
- 
four-way stretch
- 
breathable
- 
pilling resistant

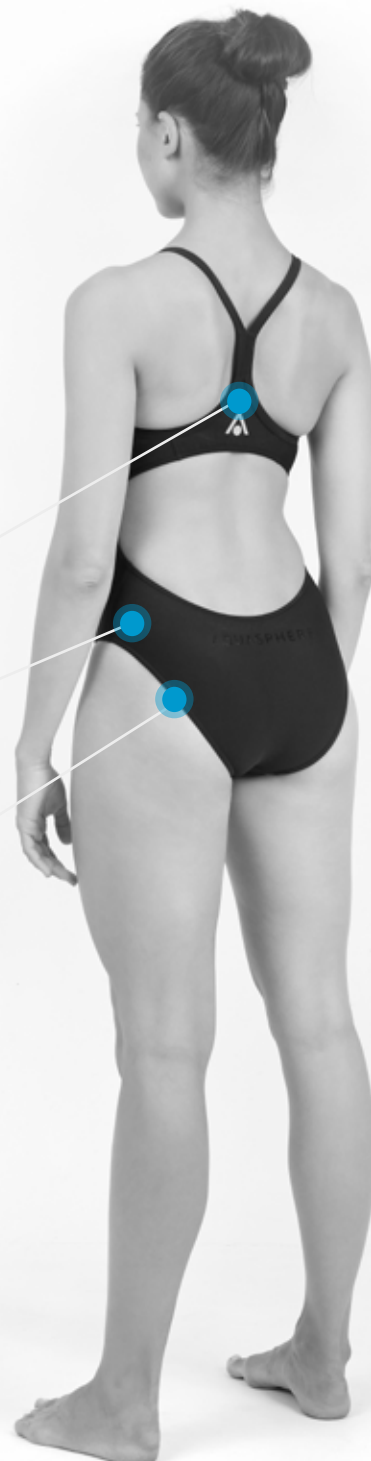

FLY BACK
Greater flexibility

100%
Chlorine resistant

MIDDLE-LEG CUT
Greater coverage



NEW

>>> **SW4670107** <<<
BLACK & YELLOW
34/36/38/40/42/44/46/48



NEW

>>> **SW4679904** <<<
MULTICOLOR NAVY
34/36/38/40/42/44/46/48



NEW

>>> **SW4670408** <<<
NAVY & ORANGE
34/36/38/40/42/44/46/48

OTHER FEATURES

- Durable Fabric Elasticity
- Double lining
- X-Play composition: 78% Recycled Polyester (100% regenerated from PET plastic bottles) + 22 % Elastolefin

* Based on 1L bottle and size 36

CLASSICBACK

ESSENTIALS

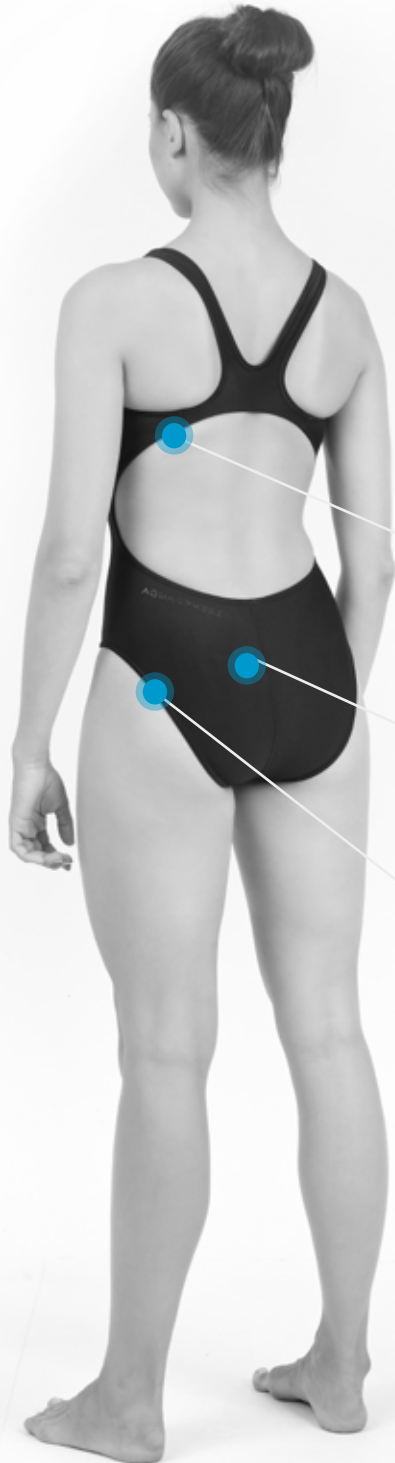

The Essential Classic Back has been designed to assure long lasting comfort during swim training. Crafted with X- Play sustainable fabric, it allows high flexible fit guaranteeing greater range of motion.

This training suit is made of 4 plastic bottles!*



CLASSIC BACK
Greater coverage & better stability

100%
Chlorine resistant

MIDDLE-LEG CUT
Greater coverage

OTHER FEATURES

- Durable Fabric Elasticity
- Double lining
- X-Play composition: 78% Recycled Polyester (100% regenerated from PET plastic bottles) + 22% Elastolefin

* Based on 1L bottle and size 36



NEW

>>> **SW4680107** <<<

BLACK & YELLOW

34/36/38/40/42/44/46/48



NEW

>>> **SW4689904** <<<

MULTICOLOR NAVY

34/36/38/40/42/44/46/48



NEW

>>> **SW4680408** <<<

NAVY & ORANGE

34/36/38/40/42/44/46/48

MEN

SIZE		3XS	2XS	XS	S	M	L	XL
FR		65	70	75	80	85	90	95
UK / US		26	28	30	32	34	36	38
DE / A / CH		1	2	3	4	5	6	7
IT		40	42	44	46	48	50	52
HEIGHT	cm	133-140	141-152	153-165	166-172	173-179	180-183	184-186
	inches	52,4 - 55,1	55,5 - 59,8	60,2 - 64,9	65,3 - 67,7	68,1 - 70,5	70,9 - 72	72,4 - 73,2
WAIST	cm	71	73	75	80	85	90	95
	inches	27,5	28,5	29,5	31,5	33,5	35,5	37,5
HIPS	cm	84	88	90	95	100	105	110
	inches	33	34,5	35,5	37,5	39,5	41,5	43,5

WOMEN

FR		34	36	38	40	42	44	46	48
UK / US		28	30	32	34	36	38	40	42
DE / A / CH		32	34	36	38	40	42	44	46
IT		38	40	42	44	46	48	50	52
HEIGHT	cm	168	170	172	174	176	178	180	182
	inches	66	66,9	67,7	68,5	69,3	70	70,8	71,6
CHEST	cm	81 - 84	85 - 90	91 - 95	96 - 100	101 - 105	106 - 110	111 - 115	116-120
	inches	32 - 33	33,5 - 35,5	36 - 37,5	38 - 39,5	40 - 41,5	41,5 - 43,5	43,5 - 45,5	45,5 - 47,2
WAIST	cm	62 - 65	66 - 70	71 - 75	76 - 80	81 - 85	86 - 90	91 - 95	96-100
	inches	24,5 - 25,5	26 - 27,5	28 - 29,5	30 - 31,5	32 - 33,5	34 - 35,5	36 - 37,5	37,8 - 39,4
HIPS	cm	88 - 90	91 - 95	96 - 100	101 - 105	106 - 110	111 - 115	116 - 120	121-125
	inches	34,5 - 35,5	36 - 37,5	37,5 - 39,5	39,5 - 41,5	41,5 - 43,5	43,5 - 45,5	45,5 - 47	47,6 - 49,2

NOTE: THIS CHART IS INTENDED TO BE USED AS A GENERAL SIZING GUIDELINE.

A swimmer is captured from a low angle underwater in a pool. The swimmer is wearing a black swim cap with a yellow stripe and yellow-tinted goggles. They are in a streamlined position, moving forward through the water. The water is clear blue, and the lane lines of the pool are visible on either side. The lighting is bright, creating a shimmering effect on the water's surface.

PENNY OLEKSIK

TRAINING GEAR & ACCESSORIES

Our commitment to innovation leads us to design tailored training equipment and accessories dedicated to developing specific workouts and muscle groups to achieve an individual's personal training requirements.

TAKE CARE OF YOUR SWIM GOGGLE

SEA-CLR ECO FRIENDLY ANTI-FOG



>>> **SA2130040** <<<
SEA-CLR SPRAY

FEATURES

- Clean and restore plastic lenses for swim goggles
- Crystal vision and anti-fog guard
- Environmentally safe
- Physiologically safe
- Anti-fog
- Scratch-resistant
- No eye irritation
- Reef safe formula
- Made in Italy
- 30 cc

SWIM MASK AND GOGGLE CASE EYEWEAR STORAGE CASE



>>> **ST1750141** <<<
SWIM MASK CASE
110 x 230 mm



>>> **ST1760106** <<<
SWIM GOGGLE CASE
80 x 190 mm

FEATURES

- Fits and protects all your small accessories
- Two inner pocket for valuables (anti-fog, nose clip, ear plugs...)
- 3D mesh for ventilation against moisture
- EVA thermoformed case to protect and resist against impacts

TRANSITION BACKPACK

TRIATHLON BAG 35L



Organisation is key to shaving time off your transitions. The Transition bag provides dedicated spaces for all your race day and travel essentials, including 2 shoe compartments, wet bag for your suit, helmet hanger, Bike-Pump securing strap, accessory pocket for goggles and small items, expandable side pocket fitting 2 water bottles and a handy padded laptop slot. The adjustable chest and waist belt coupled with a breathable Thermoformed back panel ensure an ultra-comfortable fit before, during, and after your triathlon.



- 1 STAND ALONE STRUCTURE**
Stays upright for easy loading
- 2 THERMOFORMED BACKPANEL**
Increases air flow for greater ventilation and ultimate comfort
- 3 DRY BAG**
To store your wet items
- 4 ADJUSTABLE CHEST AND WAIST BELTS**
For perfect fit and comfort
- 5 MULTIPLE STORAGE POCKETS**
For greater items organisation
- 6 BIKE PUMP SECURING STRAPS**
Easily access and store your pump
- 7 PADDED LAPTOP COMPARTMENT**
Store and protect your device, side zipped access - fits most of 15" laptops
- 8 HELMET HANGER**
Securing hook on the front of the bag



NEW



>>> **BA2000171** <<<
BLACK & BRIGHT YELLOW
32 x 52 x 22 cm

FEATURES

- Includes dry bag: store your wet items
- Chest and waist belts: perfect fit
- Magnetic closure
- Cloth hanger

GEAR MESH BACKPACK

EQUIPMENT BAG 30L



RIGID ROLL TOP OPENING
For easy loading

MESH FABRIC
Allows maximum breathing and quick drying

POLYESTER 210D PU RIPSTOP
Lightweight and resistant to heavy loading



>>> **SA2170401** <<<
NAVY BLACK
55 x 36 x 15,5 cm

FEATURES

- Fits all your wet equipment (pull buoy, kickboard, focus snorkel...)
- 2 ways of closing: from the top or on the side to adapt to the volume of your equipment.
- Adjustable shoulder straps: allows to wear as backpack for comfort.
- One outside zip pocket: store your small accessories (eyewear, nose clip, ear plugs...)
- One outside mesh bottle pocket



FOCUS SNORKEL

SWIM TRAINING SNORKEL

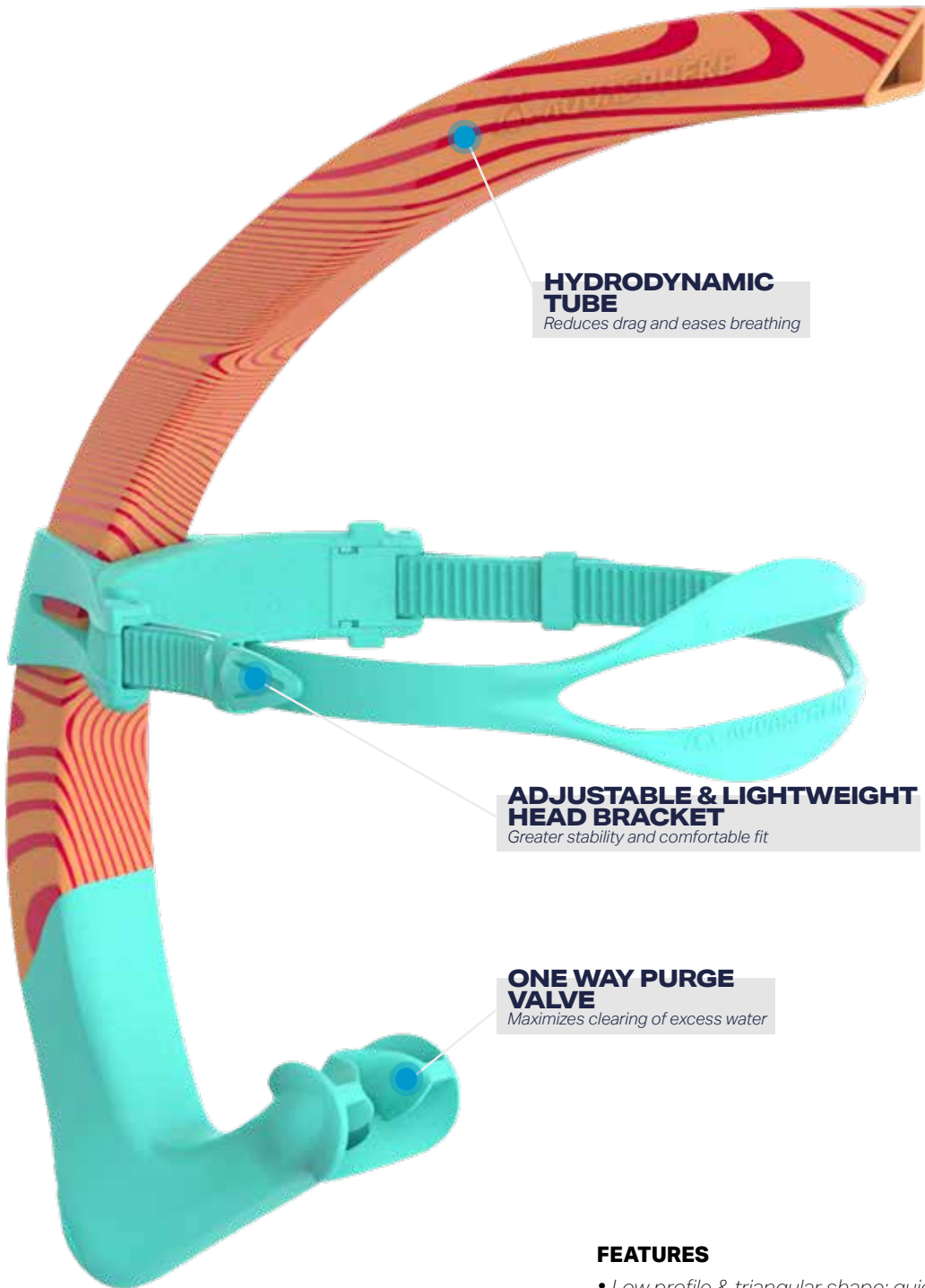

**HYDRODYNAMIC
TUBE**
Reduces drag and eases breathing

**ADJUSTABLE & LIGHTWEIGHT
HEAD BRACKET**
Greater stability and comfortable fit

**ONE WAY PURGE
VALVE**
Maximizes clearing of excess water

FEATURES

- *Low profile & triangular shape: quick water clearing*
- *Integrated cushion in head bracket : maximum comfort*
- *Silicone piece for the palate inspired from scuba diving: greater stability and comfort*
- *Soft silicone mouth piece: minimize jaw fatigue*

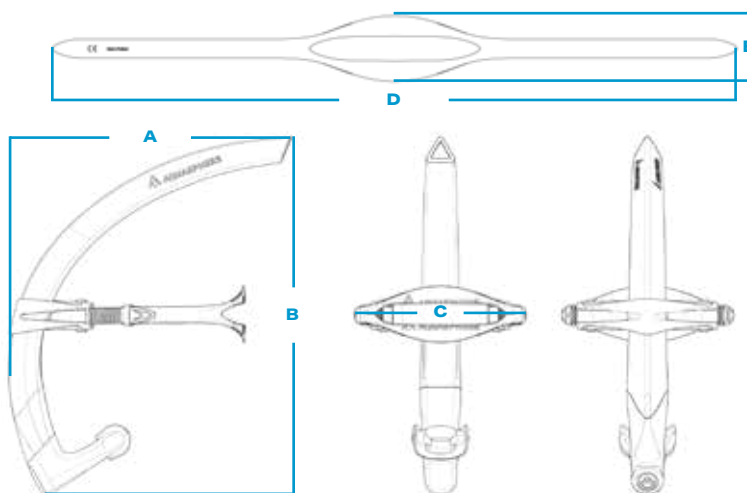

OUR SIZES	A-WIDTH (CM)	B-HEIGHT (CM)	C-BASE WIDTH (CM)	D-STRAP WIDTH (CM)	E-STRAP HEIGHT (CM)
SMALL FIT	25,5	33,9	12,1	57,6	5,5
REGULAR FIT	27,5	34,9	14	57,6	5,5

NEW



>>> **ST1724108L** <<<
LIGHT BLUE ORANGE
 Regular fit



>>> **ST1720110** <<<
BLACK GREY
 Regular fit



>>> **ST1720471** <<<
NAVY BRIGHT YELLOW
 Regular fit



>>> **ST1729904** <<<
MULTICOLOR NAVY
 Regular fit



>>> **ST1730110** <<<
BLACK GREY
 Small fit



>>> **ST1730471** <<<
NAVY BRIGHT YELLOW
 Small fit



PULL BUOY

UPPER BODY CONDITIONING



>>> **ST1520471** <<<
NAVY BRIGHT YELLOW

FEATURES

- Maximizes upper body workout by immobilizing the legs
- Isolates the arm motion to improve stroke form, strengthen and tone
- High density EVA foam with an ergonomic shape
- Durable and will not waterlog

KICKBOARD

LOWER BODY CONDITIONING



>>> **ST1740471** <<<
NAVY BRIGHT YELLOW

FEATURES

- Maximizes lower body workout by immobilizing the upper body
- High density EVA foam
- Textured to protect against scratches
- Durable and will not waterlog

ZIP VX

INCREASE THRUST AND BODY POSITION



NEW

>>> **FA3790401** <<<
BLUE & BLACK
S/M/L



NEW

>>> **FA3790101** <<<
BLACK
S/M/L

FEATURES

- Leverages natural kicking motion
- Hole in the blade for increased thrust
- Narrow blade improves kicking mechanics
- Easy-adjust buckles for a custom fit
- Non-slip pads on fin rails provide traction

USA	EU	SIZE
M 4-7 W 5-8	35-40	S
M 7-10 W 8-11	40-44	M
M 10-13 W 11-14	44-48	L

MICROFIN

LEG WORKOUT



>>> **FA3254001** <<<
BLUE / BLACK
XS/S/M/L/XL/XXL



>>> **FA3250101** <<<
BLACK / BLACK
XS/S/M/L/XL/XXL



>>> **FA3250701** <<<
YELLOW / BLACK
XS/S/M/L/XL/XXL

FEATURES

- Rigid sole helps prevent cramping
- Closed foot pocket made of durable and ultrasoft TPR polymer
- Anti-slip rubber pads for grip on slippery surfaces
- Improves technique
- Muscles reinforcement

	USA	EU	SIZE
MICROFIN	4-5	36-37	XS
MICROFIN	5-6	38-39	S
MICROFIN	6-7	40-41	M
MICROFIN	8-9	42-43	L
MICROFIN	9 ^{1/2} -10 ^{1/2}	44-45	XL
MICROFIN	11/12	46-47	XXL

ERGOFLEX

HAND PADDLES



ST1710141S
BLACK LIGHT BLUE
Small



ST1710141M
BLACK LIGHT BLUE
Medium

FEATURES

- Interconnected «bones» provide structure and resistance
- Rubber frame maintains flexibility and feel for the water
- Contoured fit mimics proper hand positioning and can flex to fit individual stroke mechanics
- Wide, adjustable hand strap for custom fit

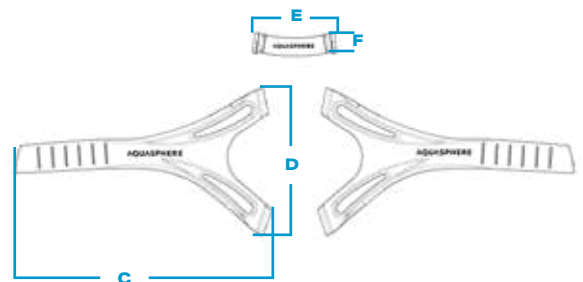
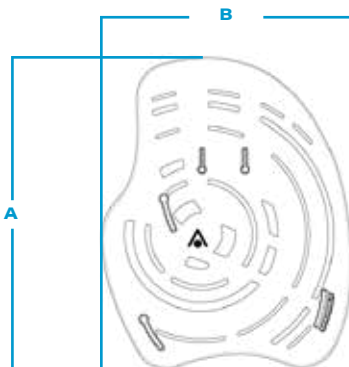

OUR SIZES	A-HEIGHT (CM)	B - WIDTH (CM)	C - STRAP WIDTH (CM)	D - STRAP HEIGHT (CM)	E - FINGER RING WIDTH (CM)	F - FINGER RING HEIGHT (CM)
S	18,7	15,1	18,6	10,6	6,1	1,5
M	22,5	18,1	23,4	13,1	6,6	1,5

SWIM GLOVES

LOW IMPACT RESISTANCE



NEW

FEATURES

- Neoprene construction: comfort and flexibility
- Webbed fingers: low impact resistance
- Help build upper body strength
- Hook & loop wrist closure: perfect fit
- Quick drying
- Reinforced stitches

>>> **SA2230171** <<<
BLACK & BRIGHT YELLOW
 S/M/L

PART		S	M	L	TOL +/-
A	HEIGHT	21.5	22.5	23.5	1
B	BOTTOMWIDTH	5.5	6	6.5	0.5
C	TOPWIDTH	22.5	23	26	1

DRY TOWEL



NEW

>>> **SA2211010** <<<
GREY
 34x44cm



NEW

>>> **SA2214141** <<<
LIGHT BLUE
 34X44cm

FEATURES

- Super-absorbent
- Fast drying
- Lightweight and soft material
- Double sided printed
- Composition: 90% PVA sponge + 10% Polyester
- Includes PET storage bottle

MICRO TOWEL



NEW

>>> **SA2250109** <<<
BLACK & WHITE
 80x40cm

FEATURES

- Ultra absorbent
- Ultra soft
- Composition: 89% polyester + 11% nylon
- Ultra soft micro fiber

TRI-CAP

ADULT SWIM CAP



>>> SA128EU0109 <<<
BLACK WHITE



>>> SA128EU3209 <<<
DARK GREEN WHITE



>>> SA128EU0601 <<<
RED BLACK



>>> SA128EU7110 <<<
BRIGHT YELLOW GREY

FEATURES

- Designed for training and competition
- Semi-formed shape
- Durable chlorine-resistant Silicone

Race CAP

ADULT SWIM CAP



>>> SA218EU0109 <<<
BLACK WHITE



>>> SA218EU0901 <<<
WHITE BLACK



>>> SA218EU0471 <<<
NAVY BRIGHT YELLOW

FEATURES

- Provides a streamlined and competitive fit
- 3D cut for comfort and perfect fit
- Reduces wrinkles and drag
- 100% silicone

PLAINCAP

ADULT SWIM CAP



>>> SA212EU0109 <<<<
BLACK WHITE



>>> SA212EU3209 <<<<
DARK GREEN WHITE



>>> SA212EU2209 <<<<
DARK PINK WHITE



>>> SA212EU0601 <<<<
RED BLACK



>>> SA212EU0901 <<<<
WHITE BLACK

FEATURES

- Designed for training and competition
- Semi-formed shape
- Durable chlorine-resistant Silicone

MESH CAP

ADULT SWIM CAP



>>> SA2200109 <<<<
BLACK & WHITE
M / L



>>> SA2204109 <<<<
LIGHT BLUE & WHITE
M / L

FEATURES

- Breathable mesh fabric
- Lightweight
- Fast drying
- Wide elastic band for support
- Easy on and off
- Composition: 77% Nylon + 18.5% Elastane + 3.6% Polyester

SIZE	M	L
DIAMETER	50 - 54 CM	54 - 59 CM
HIGHT	12 CM	13 CM

AQUA COMFORT

ADULT SWIM CAP



>>> SA216EU0101 <<<<
BLACK

FEATURES

- Adjustable, ultra-lightweight and comfortable for the casual aquatic enthusiast
- Adjustable headband
- Ultra lightweight, quick-drying and durable
- 90% Polyester, 10% Rubber

AQUASTOP

WITH CASE



FEATURES

- *Soft, silicone covered nose pads provide unparalleled comfort and a tight fit*
- *Reusable transparent case*

>>> SA2150800 <<<

EAR PLUGS^{X4}

FOUR PLUGS WITH CASE



FEATURES

- *Moldable, soft ear plugs made of hypoallergenic silicone*
- *Reusable transparent box*
- *Includes 4 units*

>>> SA112EU4040 <<<



