



NORD
DYNAMIC

ESTABLISHED
IN 2023



DIVING

DYNAMICNORD.COM



NORD
DYNAMIC

Sustainable, ecological,
innovative and functional
diving equipment



**Your
Outdoor
Companion**

DYNAMICNORD.COM



Wetsuits

→ Page 28



Regulators

→ Page 102



Page 122

BCDs

→ Page 148

Fins



We know that the sea is the source of life, seems invincible, eternal and immortal, but is fragile. For this reason our products are conceived, designed and produced with this fragility in mind.

→ Page 62

Drysuits



Dynaskins → Page 72

Content

About us

- 10 The story
- 11 Our philosophy
- 12 Our diving gear – fully tested
- 13 Design and function
- 20 Dynamic sustainability
- 24 Product life cycle

Our products

- 26 Thermal Protection
- 28 Wetsuits
- 62 Drysuits
- 72 Dynaskins
- 90 Rashguards
- 94 Neoprene Accessories
- 102 Regulators
- 122 BCDs
- 128 Instruments
- 134 Masks
- 142 Snorkels
- 148 Fins
- 162 Snorkeling Sets
- 168 Bags
- 178 Accessories
- 188 Freediving
- 200 Beachlife

Service

- 206 Warranty
- 206 Product Registration
- 207 Service & Repair Center
- 210 Contact

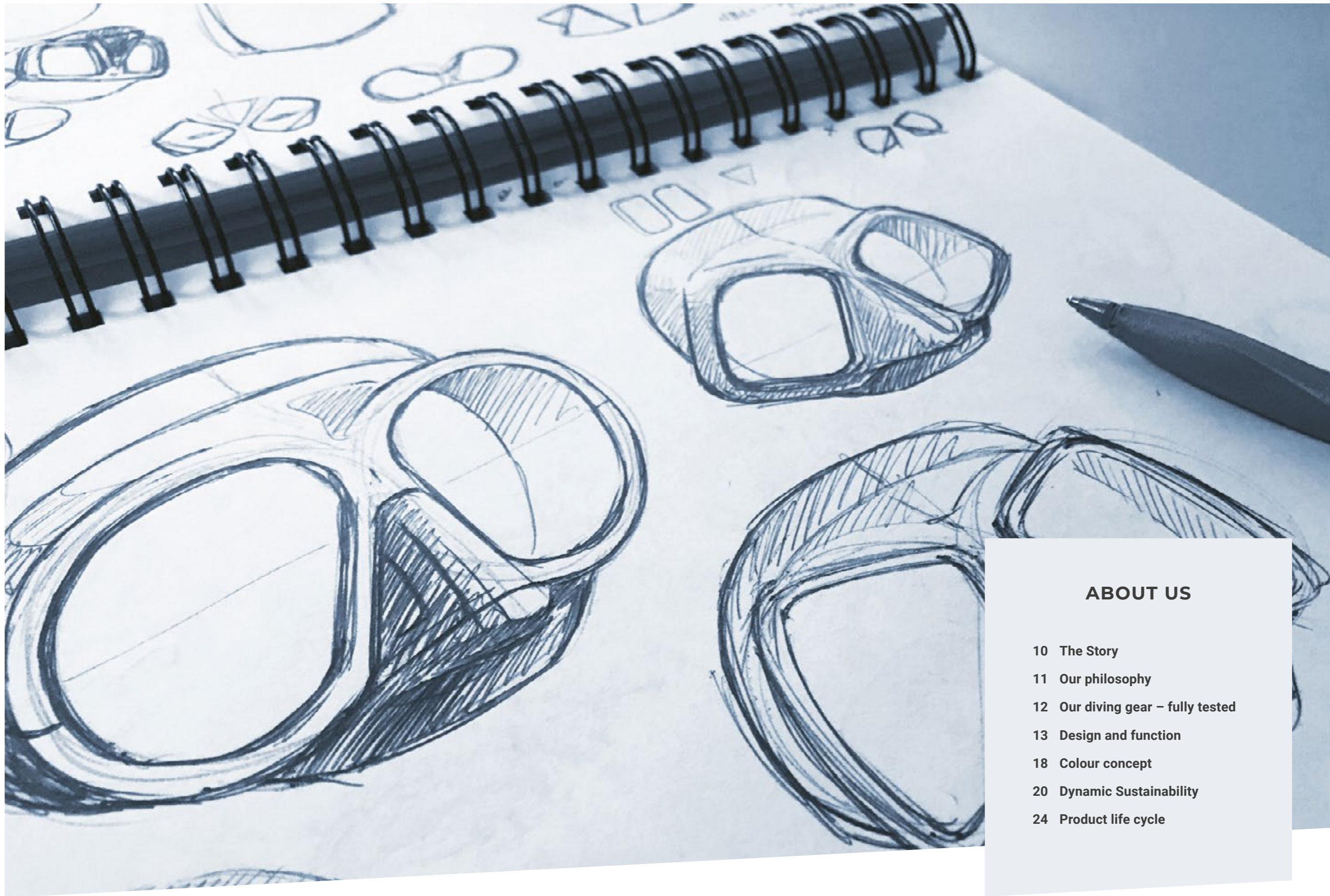

ABOUT US

- 10 The Story
- 11 Our philosophy
- 12 Our diving gear – fully tested
- 13 Design and function
- 18 Colour concept
- 20 Dynamic Sustainability
- 24 Product life cycle

The Story

Our international team brings decades of experience in practice and diving techniques. We are passionate, enterprising and sensitive to the world around us.

DYNAMICNORD was born from an initial idea in 2018 and became the personal project of its founder. He began to assemble a team with a sense of nature and human relationships, drawing from a large pool of experience above and below the water.

Like nature as a model of diversity – this team is composed of members of different nationalities and cultures. Our shared vision of the future, allows us to create a new brand that is sustainable, dynamic, innovative and global.

At our headquarters in Germany, all individual team members work together in our various departments and are committed to this vision. They work in design, development, production, sales and administration. We are confident that this great team will continue to grow each year.



We are constantly testing recycled materials and other non-polluting new generation components



Our philosophy

We meticulously select our raw materials according to the contamination levels that their production entails, as well as their degradation. For example, we have eliminated PU (the most polluting plastic) from our products and we are constantly testing recycled materials and other non-polluting new-generation components.

The human impact on our environment is already very evident, and it is our responsibility, especially in the face of the next generations, to change our attitude regarding our treatment and exploitation of nature.

As Charles Darwin said, "It is not the strongest of the species that survives, nor the most intelligent, but the one that most adapts to change."



Innovation Credibility Functionality



Our Diving Gear – fully tested

To create our products, we begin from the premise "innovation - credibility - functionality". Any innovation must be credible and to be credible it must be functional.

Above all, we are divers, and as followers of this sport, we know what we need. **DYNAMICNORD** products combine effective protection with considerable ease of movement, the two basic requirements for working underwater. Rigorous testing is conducted on all our products prior to a full-fledged product launch. Once a new design has been thoroughly tested in-house, we turn to our expert team of test divers for the final round of evaluations.

Design & function

Our focus is to make you love **DYNAMICNORD** products and be proud to use them.

In our design department we do not want to create ephemeral and fashionable products. We want to provide you with reliable equipment to explore nature and the ocean depths.

DYNAMICNORD products are driven by emotions - we create products based on a deep understanding of the diver's needs and desires. What are the non-visible elements that enhance your diving performance? What kind of products help you create an unforgettable diving experience? What is your perfect „adventure gear“?

This discussion is supported by the experience and input of our founder, Martin Kusche, and the international team of people he has built around him. We believe that drawing on their experience is irreplaceable in designing the best possible products from scratch.

Martin Kusche



designed
engineered
in germany



Asking the right questions

is at the core of our processes. Going through the process of defining and answering those questions helps us prepare our most visible design work.

Development for every new product starts with a wide range of questions – to understand the product, to put it in the right context, to generate new ideas by understanding the core requirements of the product, and to observe the user and his attitude towards the product – just to mention a few basics.

With this approach, we are generating innovations that often lead to the development of patentable solutions designed by our team in Germany.

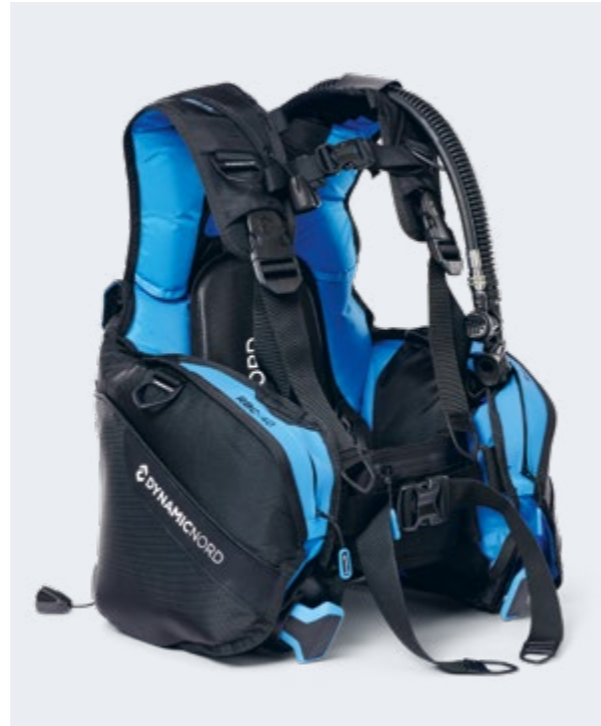

Design language

is a very important aspect of our **DYNAMICNORD** products. Once a new product is conceptualized, we focus on making it part of the **DYNAMICNORD** product family. Our design language helps us bring all the different types of products together under one big roof. All "family members" share the same ideological perspective, such as environmentally friendly production, sustainable materials, and development approach. Finally, the brand and its family members are also defined by a common visual aspect; consistency in design and appearance generate the same emotion for the user: **DYNAMICNORD** products are reliable and original products for the outdoors.

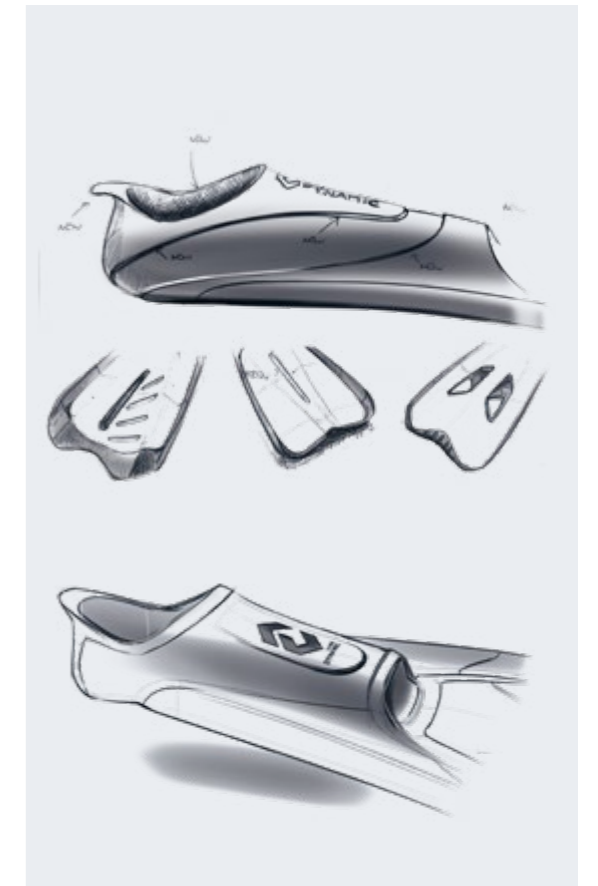

14

For the development of our integrated weight system, for example, we have been able to set a new standard of innovation unmatched by current state-of-the-art products. The approach is advantageous: the aesthetic part of the design is predefined by this process and ready to be worked on in detail. This is where our design language comes into play.

designed
engineered
in germany

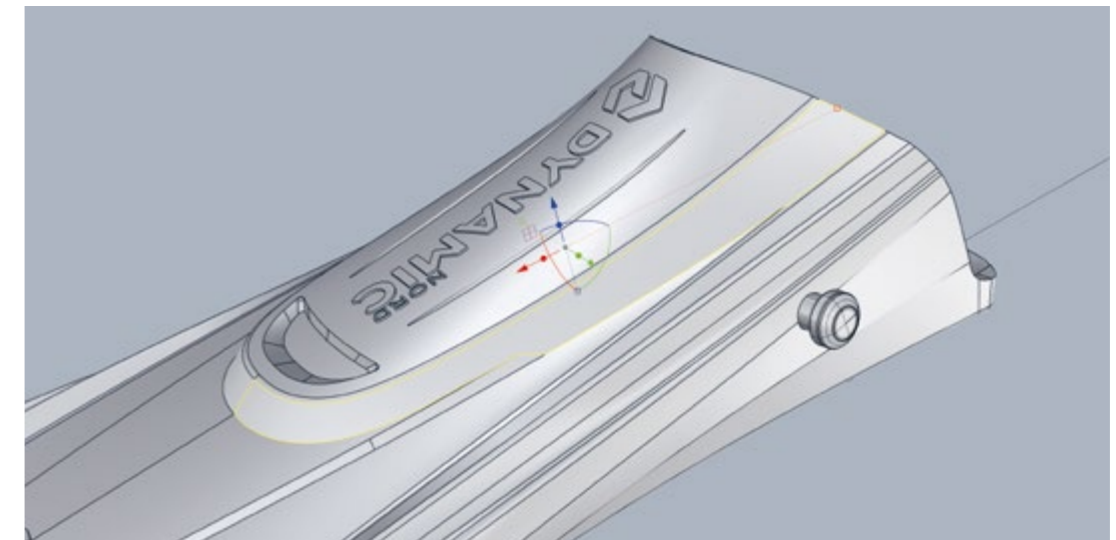
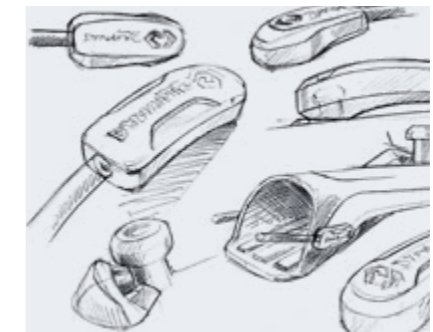
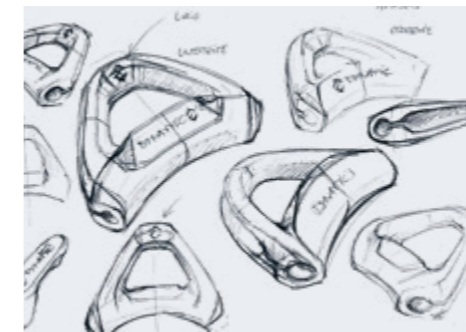
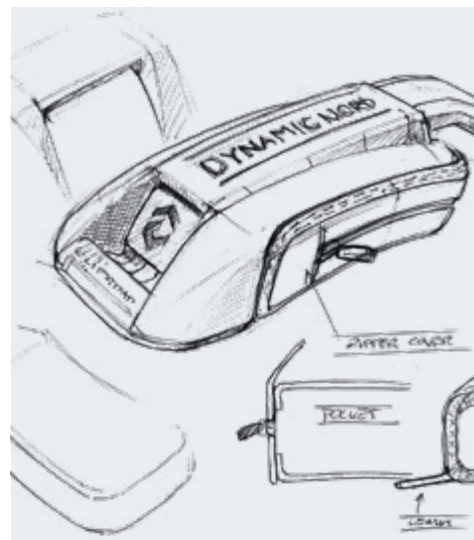

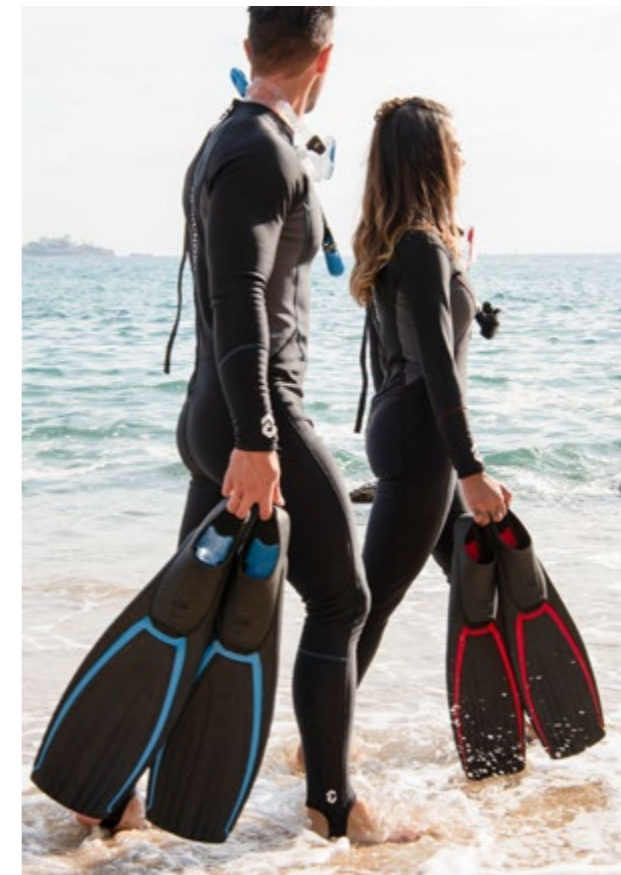
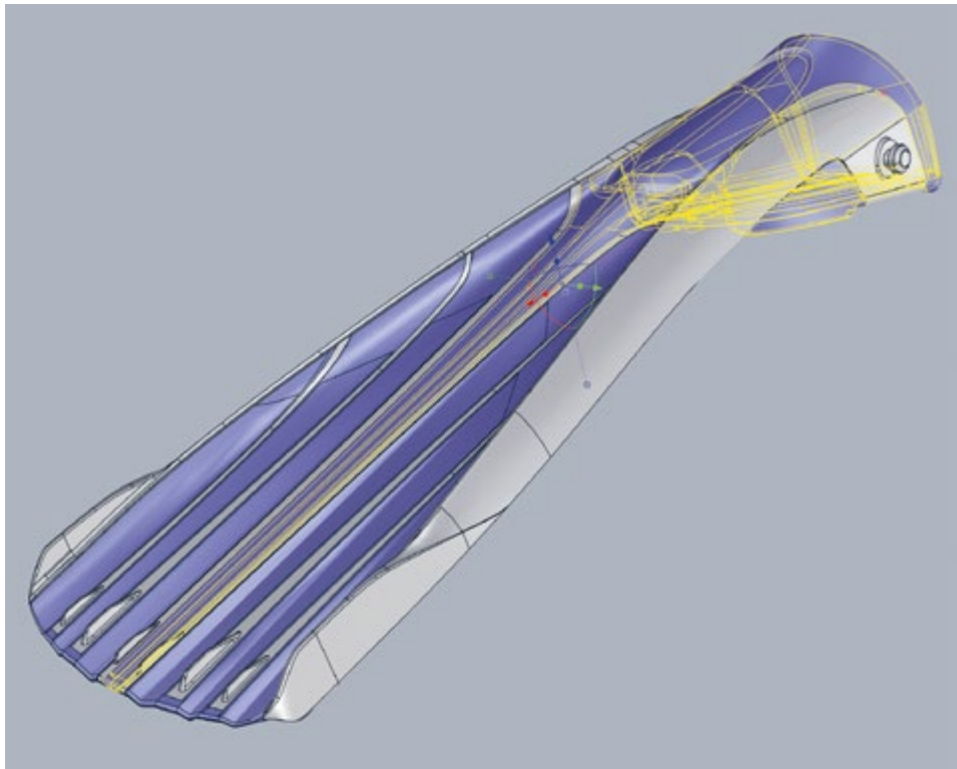

**designed
engineered
in germany**

Recognized all over the world,
German design and engineering are
synonymous with innovation, technology,
quality and performance excellence.

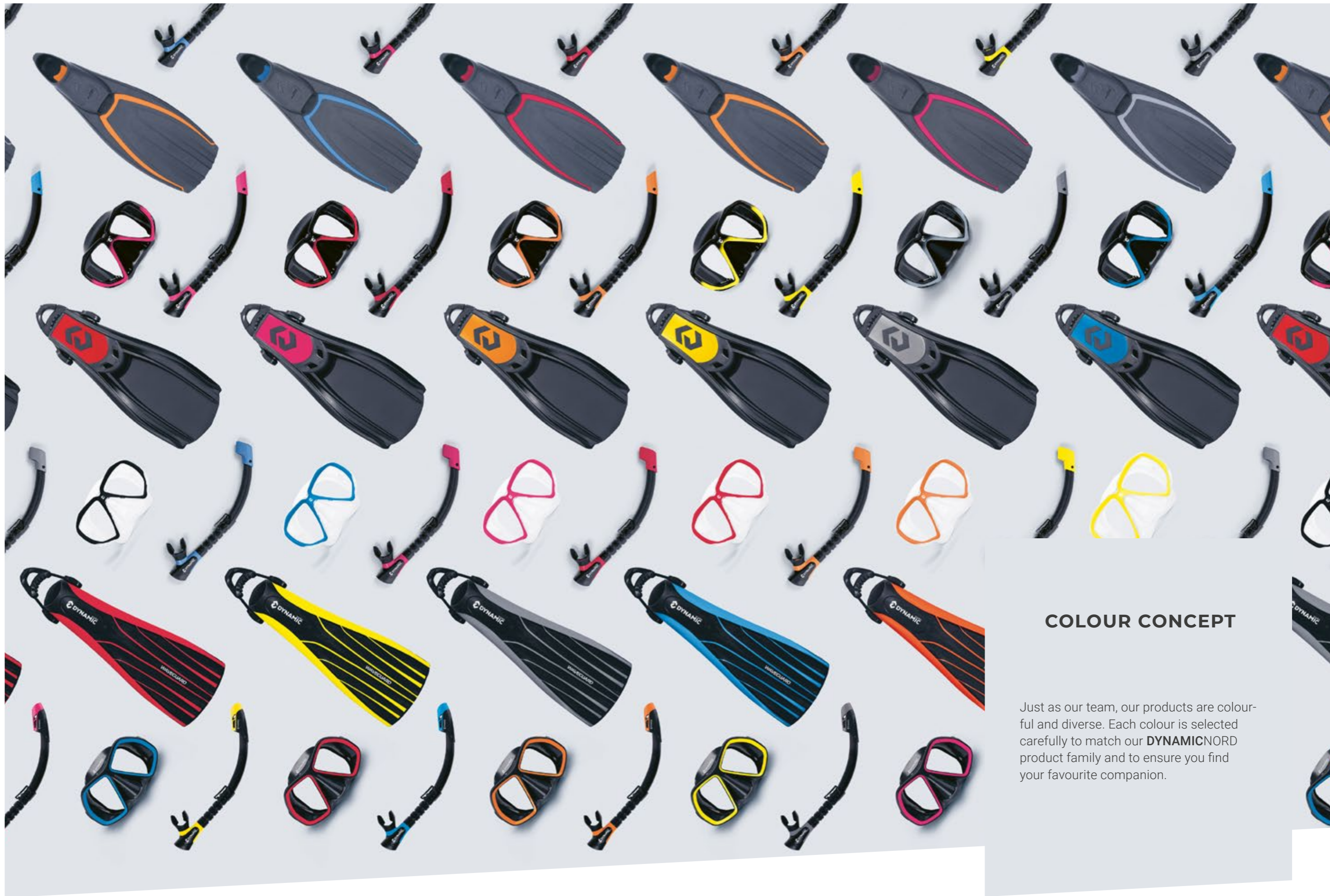

COLOUR CONCEPT

Just as our team, our products are colourful and diverse. Each colour is selected carefully to match our **DYNAMICNORD** product family and to ensure you find your favourite companion.



Dynamic Sustainability

Today, sustainability and ecology have become a global problem with unpredictable consequences. Science affirms that we are facing humanity's biggest challenge. Reversing climate change means that we must change the way we live and understand the world.

It is evident that human activity is causing a massive impact on nature and we must react positively. At **DYNAMICNORD**, we work every day to reduce our environmental impact in all manufacturing processes and throughout the life of the product.

Our R&D department works following the guidelines and premises of the most outstanding entities in terms of conservation and sustainability of the marine and terrestrial environments. We are constantly testing recycled materials and other non-polluting next-generation components to improve our products and our quality of life.

The sea is the source of life.
It seems invincible, eternal,
and immortal, but it is fragile.
Let's take care of it.

Limestone Neoprene

We use earth-mined limestone to replace petrochemicals in our neoprene. It comes from nature and has less environmental impact.



Eco Carbon Black

Carbon Black, one of the key ingredients of neoprene, can now be pyrolyzed from scrap rubber tires. This reduces energy consumption and cuts CO₂ emission by 200 g per wetsuit.

Neoprene



PAHs Minimized Formulation

DYNAMICNORD neoprene rubber foam formulation eliminated near all of the polycyclic aromatic hydrocarbon (PAHs) substances.

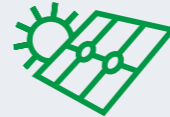

Solar Energy System

We work on making our production even greener. We focus on production facilities for finished goods which are equipped with solar panels on the roof tops to provide green energy.



Water-saving dyeing machine

We are reducing water and energy consumption by 60% with our dyeing machines.



Plastic Components

We are recycling almost 100% of all materials from production; anything that is TPR, PP, PC, or PVC.



Fins

Fin foot pocket inserts are made with the waste of PP and TPR mixed together, and we also have hanging hooks made with PC waste.



Production

The use of full automation increases production capacity while lowering production time, which also means that the machinery needs to work less, resulting in lower electricity and water consumption.



Masks

We recycle all the plastic parts of our masks.



Skins

Our skins are made with Polartec® technology, and Polartec® commits to 100% recycled materials and biodegradability across its entire product line.

Polartec Eco-Engineering™ has set a new standard for sustainable textiles – including the creation of the world's first fully recycled and biodegradable fleece, other knits, insulation fills, and breathable waterproof fabrics.

Polartec® recycles 1.5 billion plastic bottles, adding up to its worldwide production.



Our defined aim is to make the product life cycle working with all its details. The life cycle of a product is the progression of a product from beginning to end, from its original idea or conception to its decline at the end of its useful life. At DYNAMICNORD we pay close attention to each individual process.

We know that our customers value our green spirit and we are convinced that they will act according to this philosophy when the useful life of the product ends. Today recycling is not an option, it's a responsibility.

Loyal to our philosophy of a green spirit and maximum respect for the environment, our R & D department creates new products following this premise, trying always to be at the forefront in design and innovation.

Subsequently, our industrial engineers and graphic designers develop and design the product in all its processes and applications, always respecting the original philosophy and concept.

For us, the customer is the most important element. Our after-sales service department devotes its maximum effort to resolving any issue effectively and in the shortest possible time.

The next step is to create various prototypes to see the product physically and conduct the corresponding tests.

The prototype is tested at all levels by our experts and ambassadors. With this information we proceed to final product adjustments.

Once all the quality controls have been completed, and maintaining our green spirit, product manufacture begins.

We are convinced that our customers are satisfied with their purchases, which allow them to enjoy their preferred activities at all levels in an ecoresponsible way.

Our products are designed for immediate and safe use. With their use, our customers become ecoresponsible divers by sharing in our green spirit philosophy.

DYNAMICNORD has its own global distribution networks and authorized centers in the main countries worldwide.

Our marketing and commercial management departments then present, circulate, and promote the product through media and advertising channels.

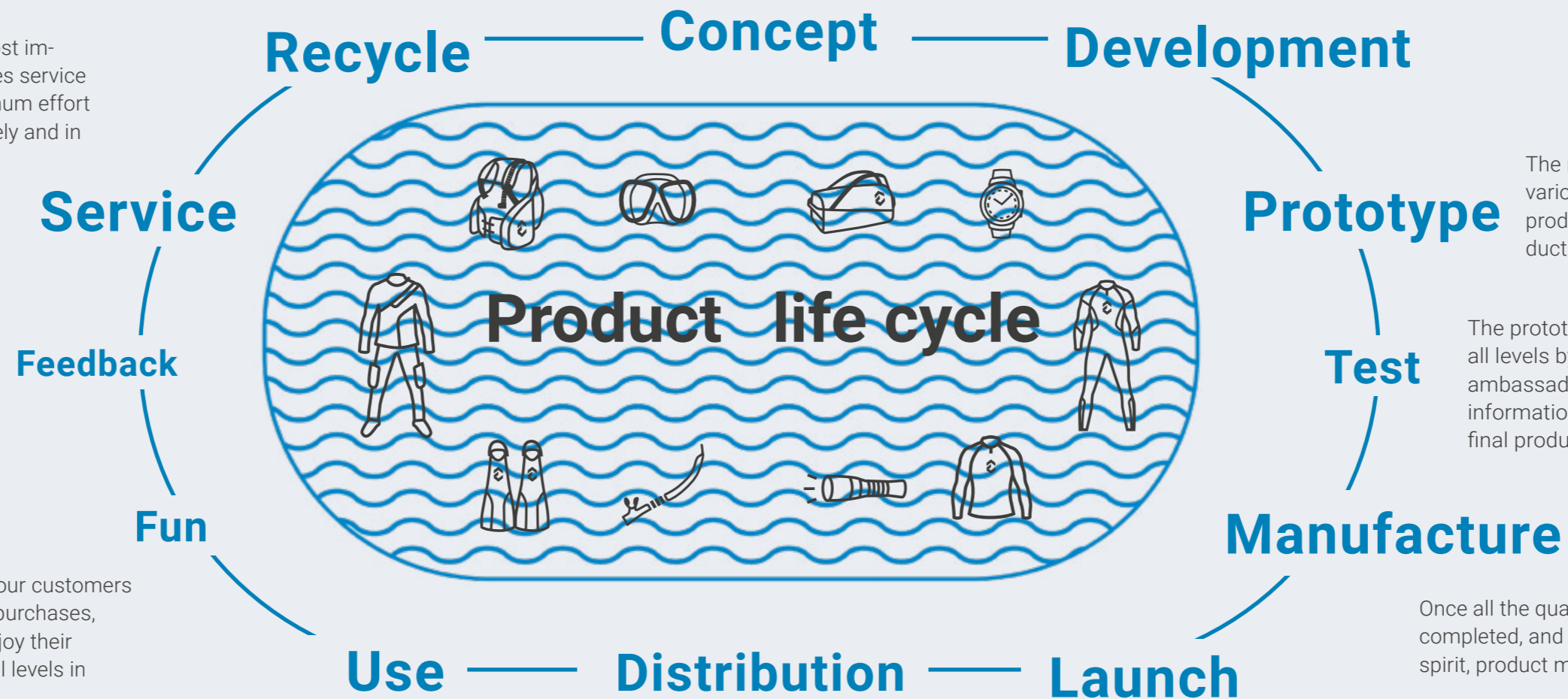

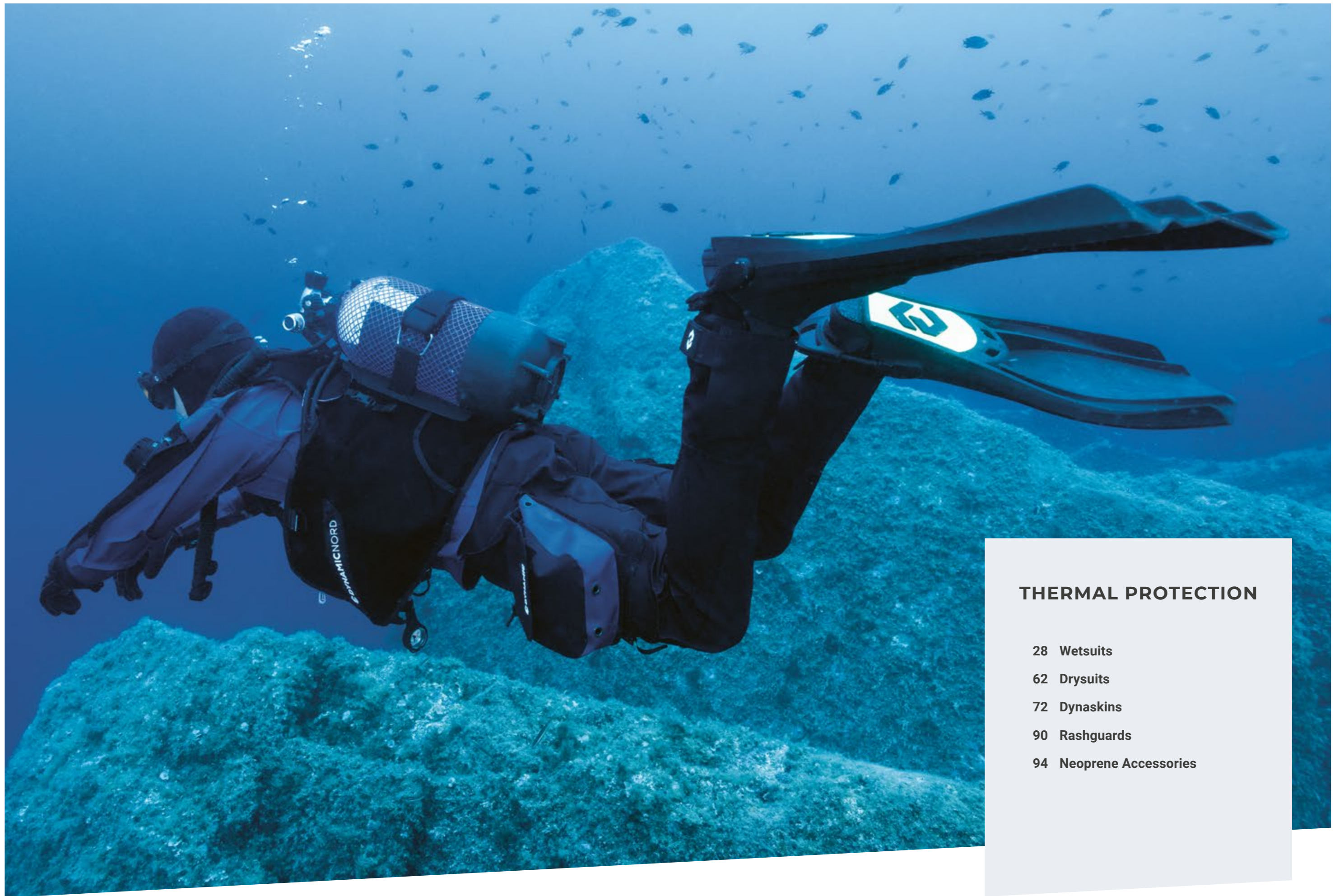

THERMAL PROTECTION

- 28 Wetsuits
- 62 Drysuits
- 72 Dynaskins
- 90 Rashguards
- 94 Neoprene Accessories



WETSUITS

Different models, colours and thicknesses to satisfy your needs. Furthermore, our neoprene is eco-friendly!

SP-SERIES

Fullsuits Men / Women / 5 mm / 7 mm

FOR DEMANDING DIVERS



designed
engineered
in germany

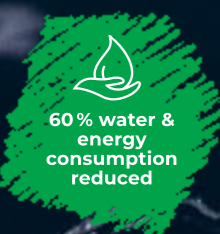



SP-51

Fullsuit 5 mm

SP-71

Fullsuit 7 mm

SP-52

Fullsuit 5 mm

SP-72

Fullsuit 7 mm

Perfect for demanding divers / **Zippers and seals on wrists and ankles for easy donning and doffing** / Shoulder and knee reinforcements / **3D pattern on the preformed arms and legs gives maximum comfort**

We designed this wetsuit for the most demanding divers. Available in 5 mm and 7 mm. The wetsuits are equipped with zippers and seals on the wrists and ankles for easy donning and doffing. The back zipper is sealed and doesn't allow water circulation, and the wrists are perfectly sealed with our sleeves. The three-dimensional pattern on the preformed arms and legs gives the most relaxed feeling under water. Shoulder and knee protectors are perfectly integrated into the suit and don't reduce the flexibility in these areas.

The 7 mm version is rated Class A for its thermal protection capability.

80 % Neoprene / 20 % Nylon

designed
engineered
in germany



Men
black/blue

XS	S	M	MT	MLS	ML	MLT	LS	L
LT	XLS	XL	XLT	2XLS	2XL	3XL	4XL	



Women
black/red

XS	S	ST	M	MT	M+	L	LT	L+
XL	XL+	2XL	2XL+	3XL	4XL			

For more details see sizechart on page 58/59



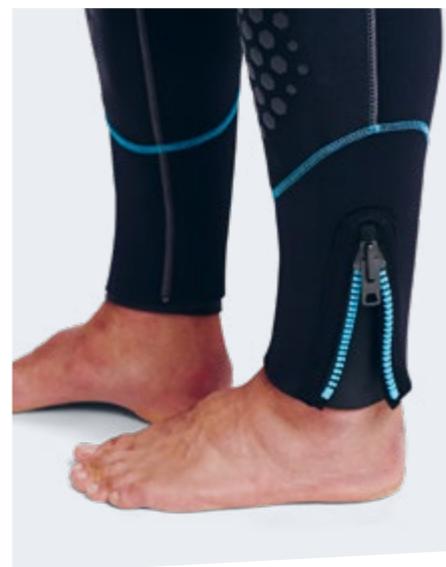
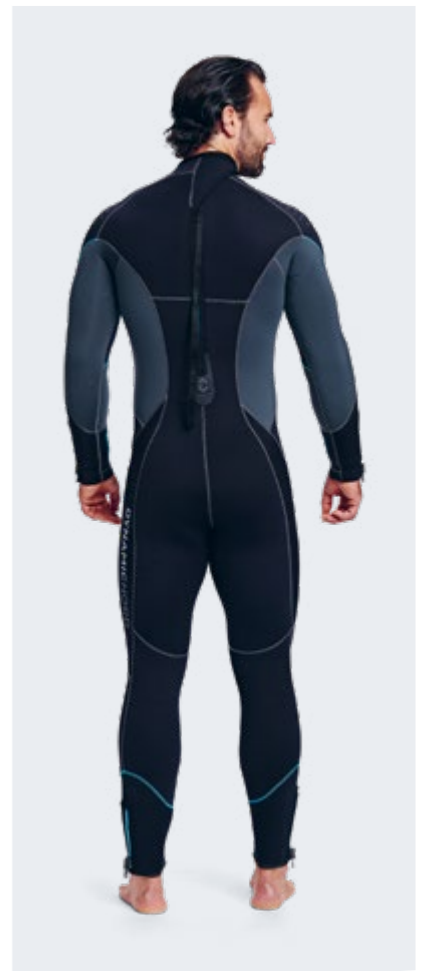
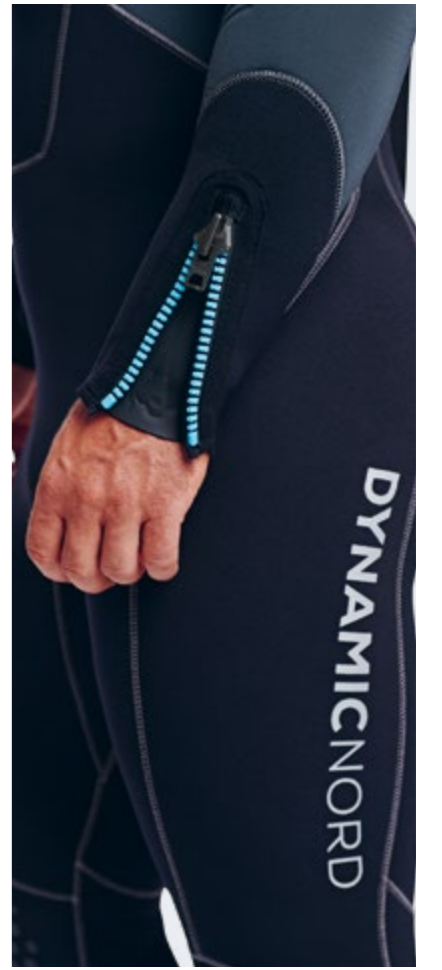
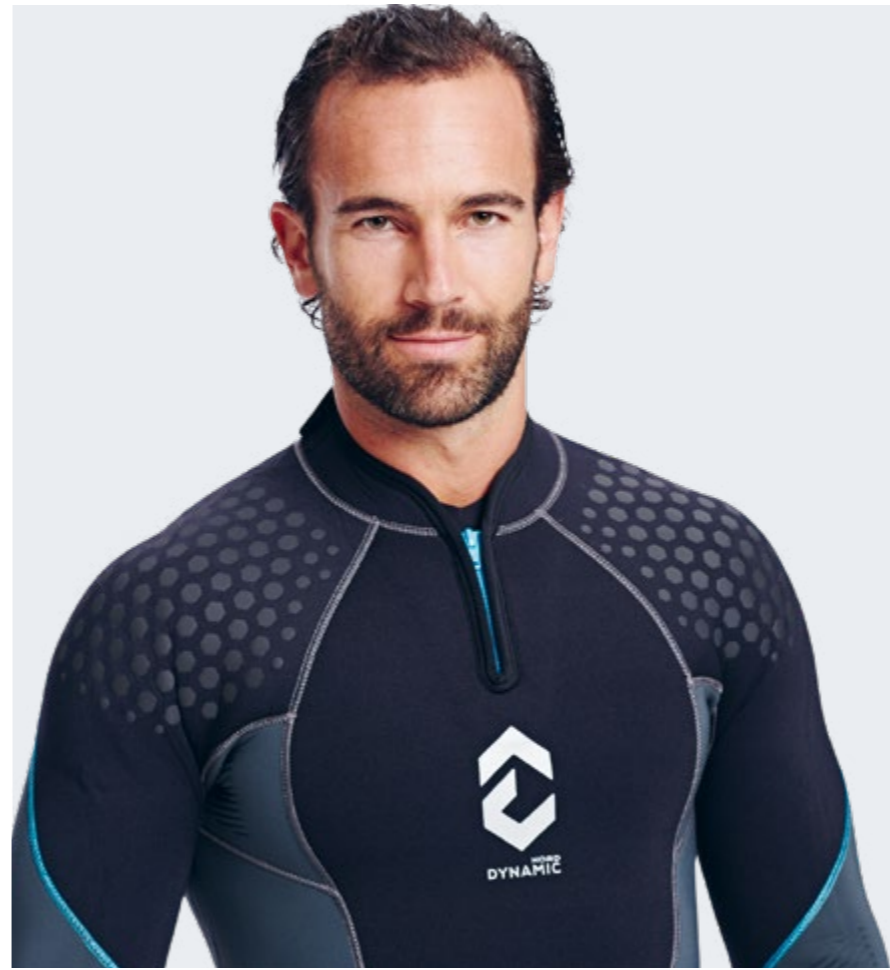
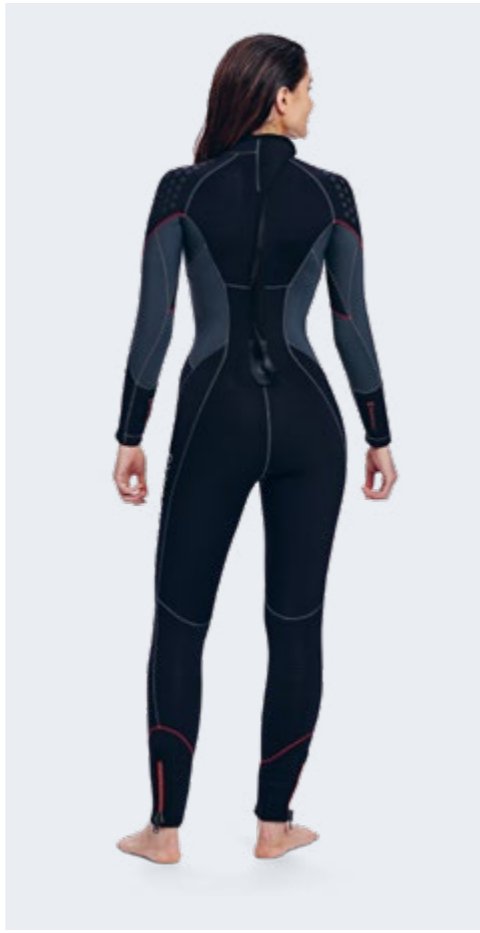
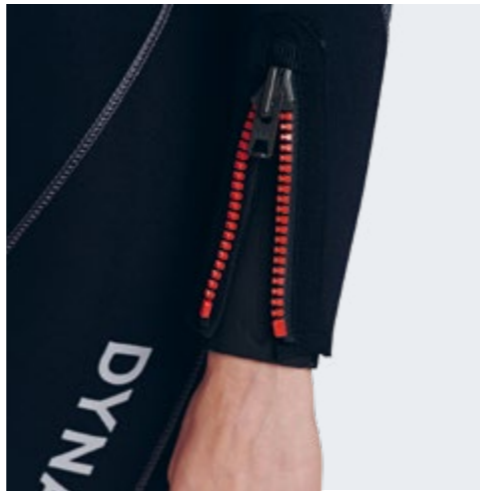
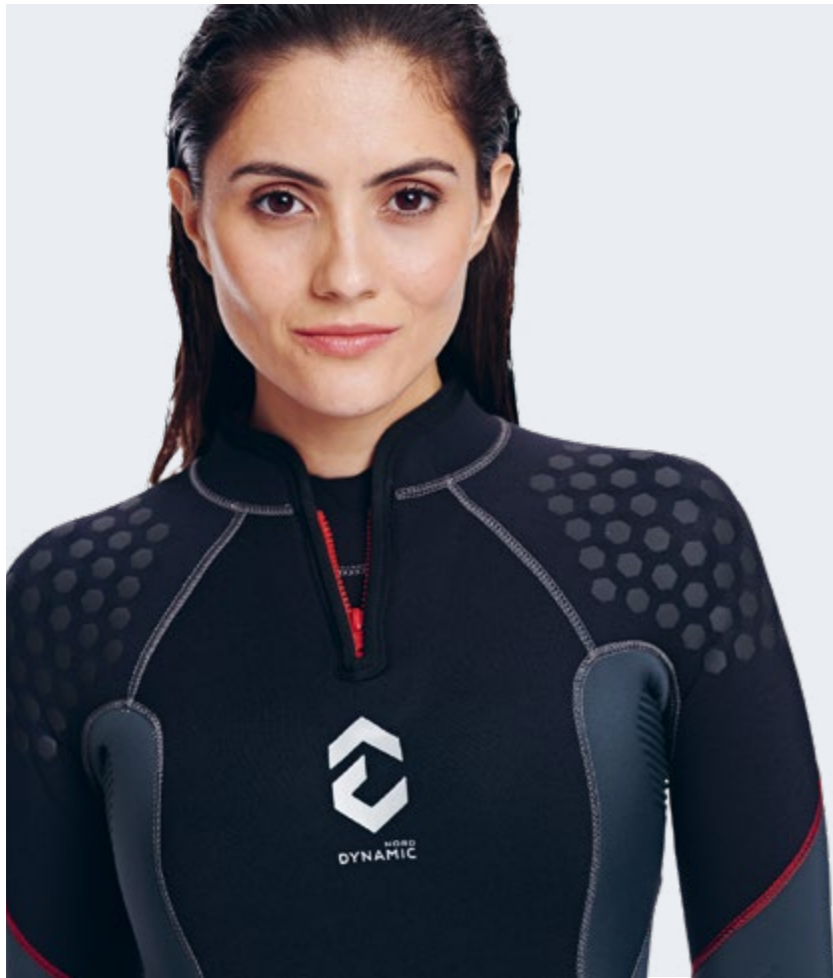

Limestone neoprene

We use earth-mined limestone neoprene to replace petrochemicals. Through the pyrolysis process of Eco Carbon Black (obtained from recycling rubber tires), the energy consumption and CO₂ emissions are reduced by 200g per wetsuit. The fabric dyeing process saves up to 60% in water and energy consumption.



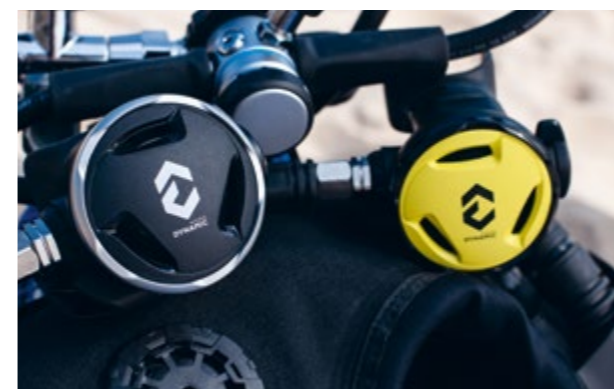

SL-SERIES

Fullsuits / with Hood

FOR ADVANCED DIVERS



Limestone neoprene

designed
in germany



38 THERMAL PROTECTION

38

39

SL-31

Fullsuit 3 mm

SL-32

Fullsuit 3 mm





Perfect for advanced divers / **Limestone neoprene** / Available in 3 mm, 5 mm, or 7 mm full suit / **Available in 5 mm and 7 mm fullsuit, hood attached, front zip** / Reinforced shoulders and knees / **Zippers at wrists, ankles, and neck**

This is the perfect wetsuit for advanced divers. The very stretchy neoprene gives the ideal feeling of comfort, both on the surface and during the dive. Zippers at the wrists and ankles help to make donning and doffing easy. The zipper on the neck releases pressure in this sensitive area when out of the water and can be adjusted when you start diving to provide the water tightness you need to minimize water circulation and the feeling of cold. Shoulder and knee reinforcements protect these stressed areas from mechanical abrasion.

90% Neoprene / 10% Nylon

designed in germany  Limestone neoprene

	Men	XS	S	M	ML	L
	black/yellow	XL	2XL	3XL	4XL	
	Women	XS	S	M	L	
	black/purple	XL	2XL	3XL		

For more details see sizechart on page 58/59



SL-51

Fullsuit 5 mm

SL-52

Fullsuit 5 mm





Perfect for advanced divers / **Limestone neoprene** / Available in 3 mm, 5 mm, or 7 mm full suit / **Available in 5 mm and 7 mm fullsuit, hood attached, front zip** / Reinforced shoulders and knees / **Zippers at wrists, ankles, and neck**

This is the perfect wetsuit for advanced divers. The very stretchy neoprene gives the ideal feeling of comfort, both on the surface and during the dive. Zippers at the wrists and ankles help to make donning and doffing easy. The zipper on the neck releases pressure in this sensitive area when out of the water and can be adjusted when you start diving to provide the water tightness you need to minimize water circulation and the feeling of cold. Shoulder and knee reinforcements protect these stressed areas from mechanical abrasion.

90% Neoprene / 10% Nylon

designed in germany  Limestone neoprene

	Men	XS	S	M	ML	L
	black/red	XL	2XL	3XL	4XL	
	Women	XS	S	M	L	
	black/red	XL	2XL	3XL		

For more details see sizechart on page 58/59

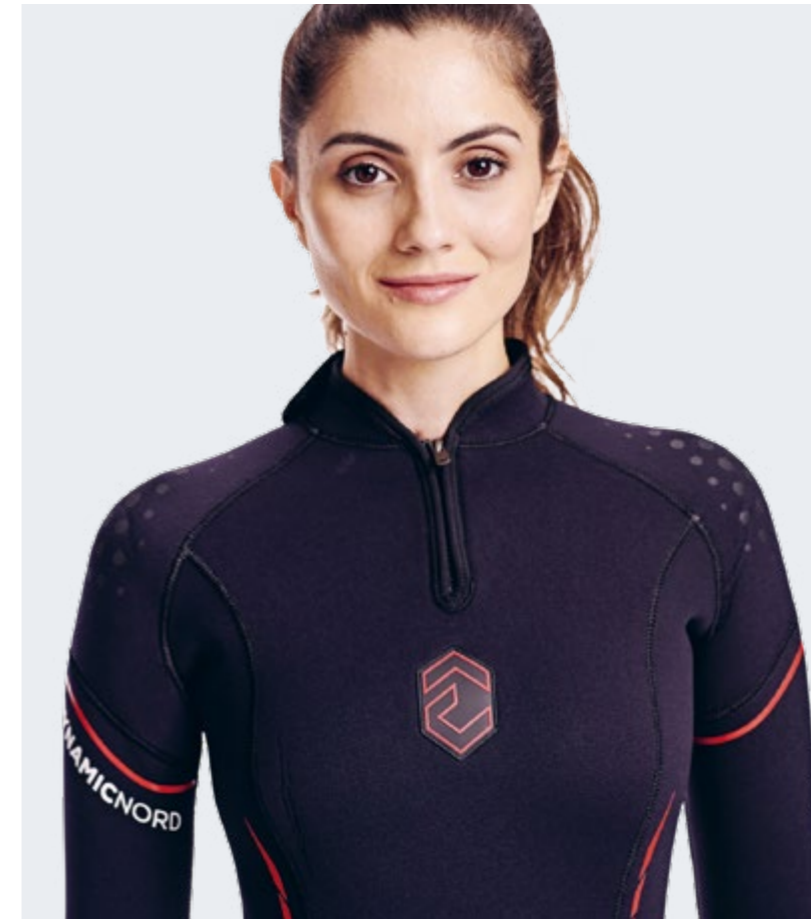

Limestone neoprene
We use earth-mined limestone neoprene to replace petrochemicals. Through the pyrolysis process of Eco Carbon Black (obtained from recycling rubber tires), the energy consumption and CO₂ emissions are reduced by 200g per wetsuit. The fabric dyeing process saves up to 60% in water and energy consumption.

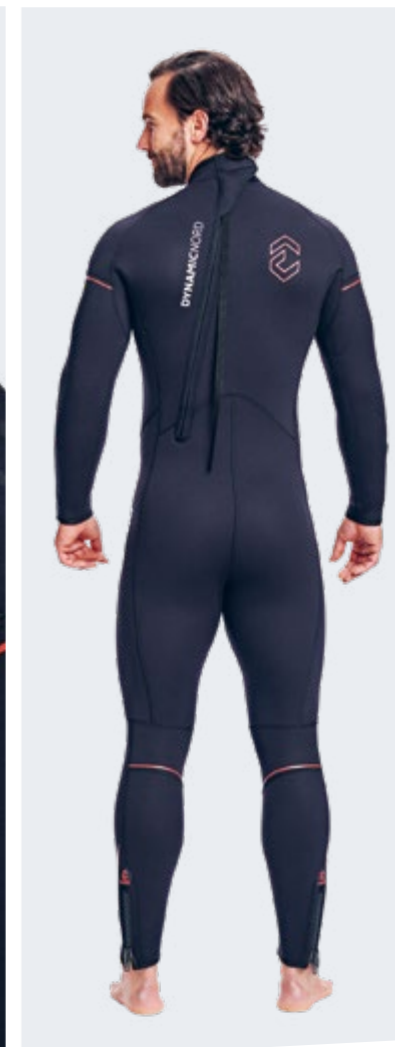

SL-71

Fullsuit 7 mm

SL-72

Fullsuit 7 mm





Perfect for advanced divers / **Limestone neoprene** / Available in 3 mm, 5 mm, or 7 mm full suit / **Available in 5 mm and 7 mm fullsuit, hood attached, front zip** / Reinforced shoulders and knees / **Zippers at wrists, ankles, and neck**

This is the perfect wetsuit for advanced divers. The very stretchy neoprene gives the ideal feeling of comfort, both on the surface and during the dive. Zippers at the wrists and ankles help to make donning and doffing easy. The zipper on the neck releases pressure in this sensitive area when out of the water and can be adjusted when you start diving to provide the water tightness you need to minimize water circulation and the feeling of cold. Shoulder and knee reinforcements protect these stressed areas from mechanical abrasion.

90% Neoprene / 10% Nylon

designed in germany  Limestone neoprene

	Men	XS	S	M	ML	L
	black/blue	XL	2XL	3XL	4XL	
	Women	XS	S	M	L	
	black/yellow	XL	2XL	3XL		

For more details see sizechart on page 58/59



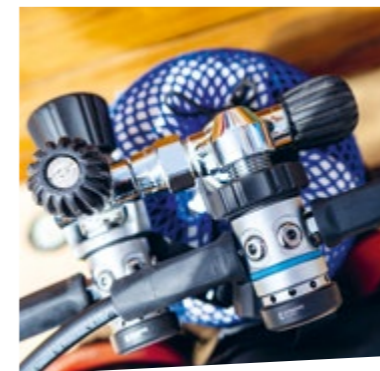
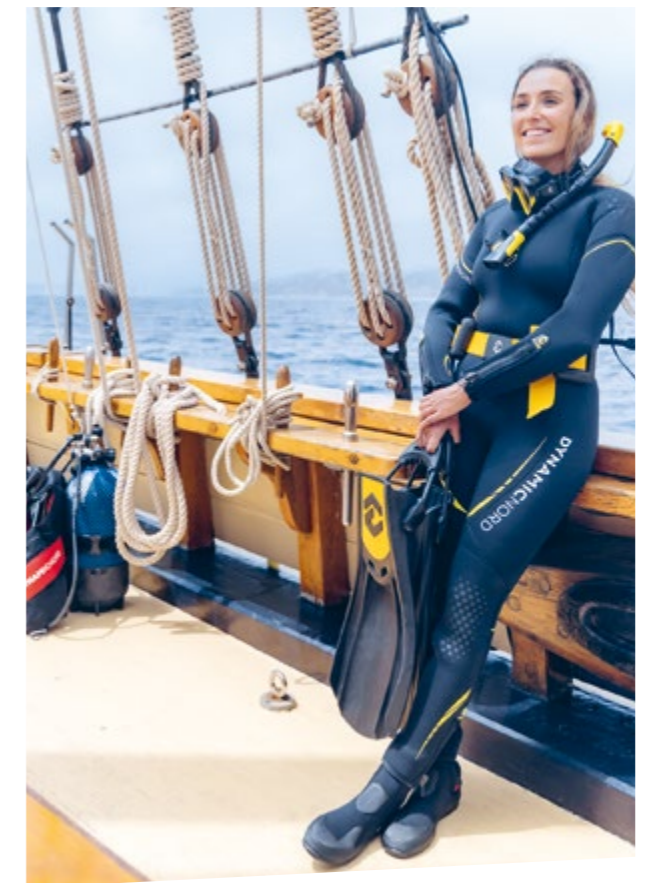
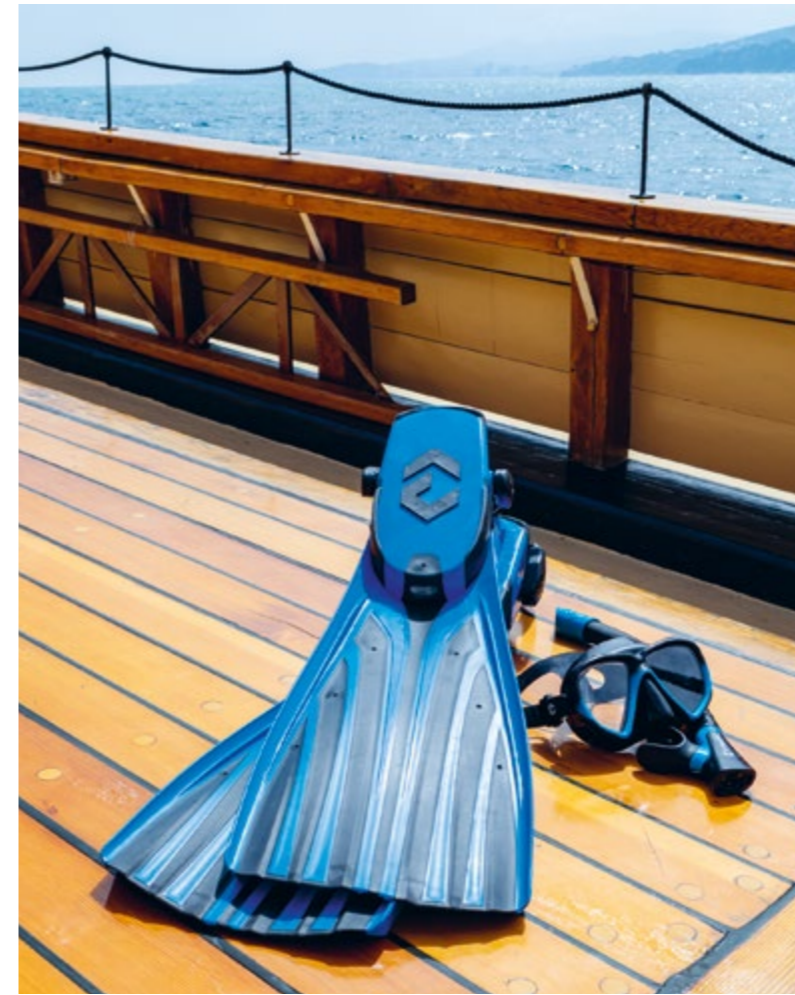
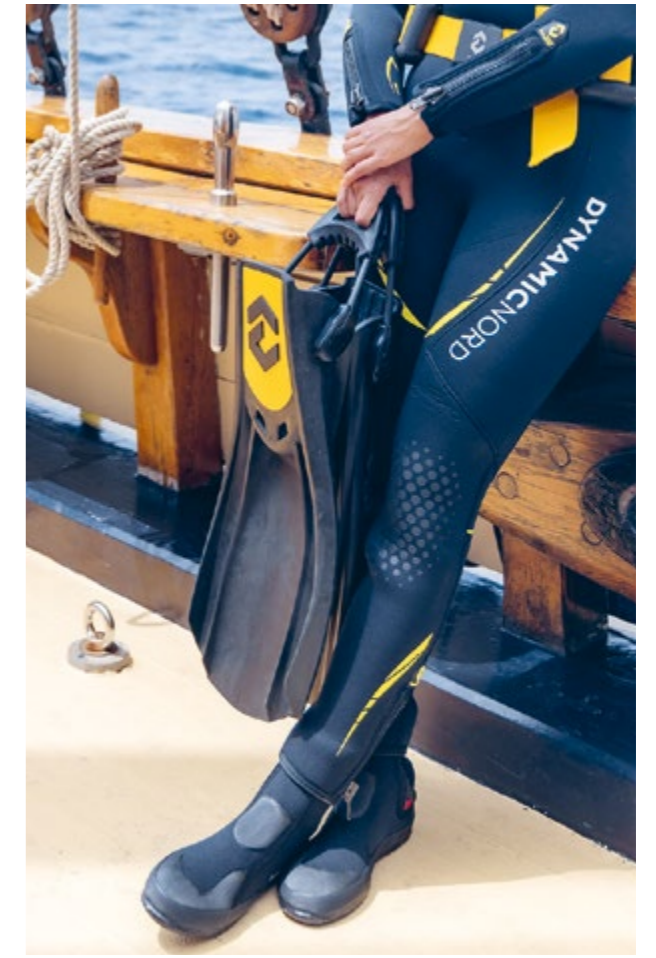

SL-51-H

Fullsuit Hood 5 mm

SL-71-H

Fullsuit Hood 7 mm

SL-52-H

Fullsuit Hood 5 mm

SL-72-H

Fullsuit Hood 7 mm



Perfect for advanced divers / **Limestone neoprene** / Available in 3 mm, 5 mm, or 7 mm full suit / **Available in 5 mm and 7 mm fullsuit, hood attached, front zip** / Reinforced shoulders and knees / **Zippers at wrists, ankles, and neck**

This is the perfect wetsuit for advanced divers. The very stretchy neoprene gives the ideal feeling of comfort, both on the surface and during the dive. Zippers at the wrists and ankles help to make donning and doffing easy. The zipper on the neck releases pressure in this sensitive area when out of the water and can be adjusted when you start diving to provide the water tightness you need to minimize water circulation and the feeling of cold. Shoulder and knee reinforcements protect these stressed areas from mechanical abrasion.

90% Neoprene / 10% Nylon

designed in germany  Limestone neoprene



Men
black/red

XS	S	M	ML
L	XL	2XL	3XL



Women
black/red

XS	S	M	L
XL	2XL	3XL	

For more details see sizechart on page 58/59

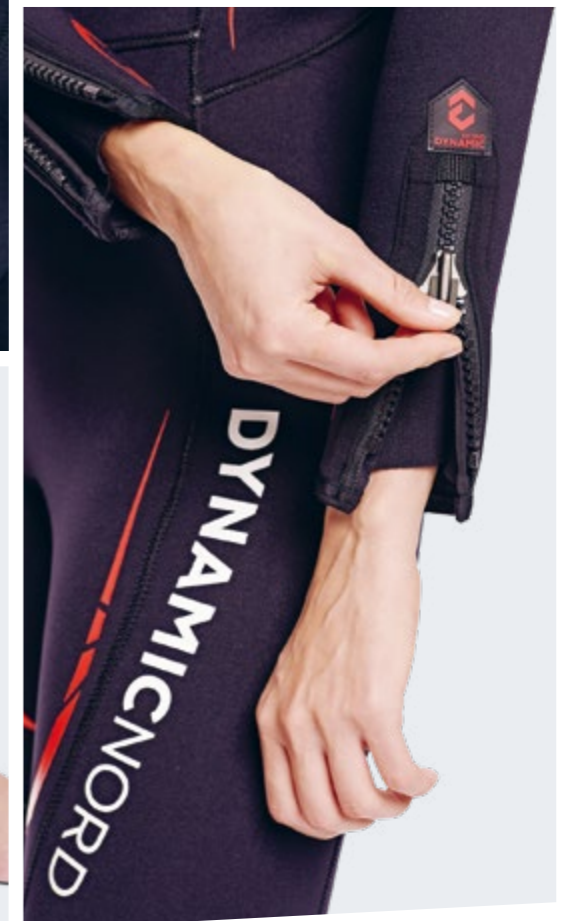
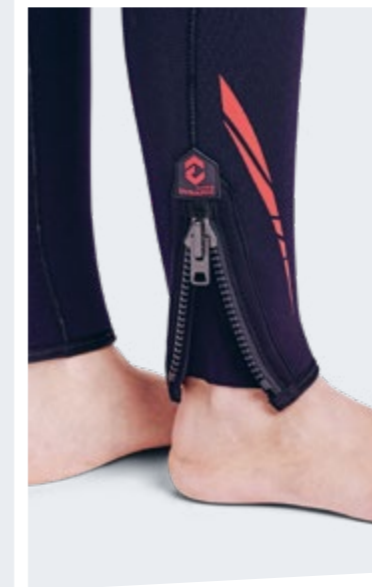
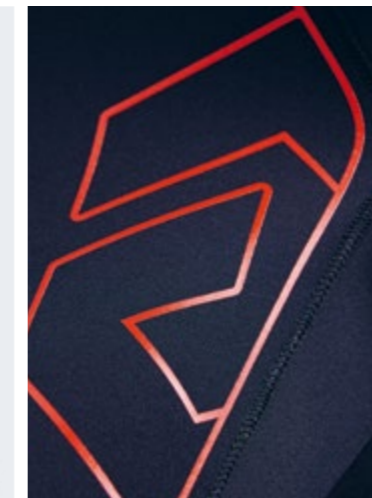
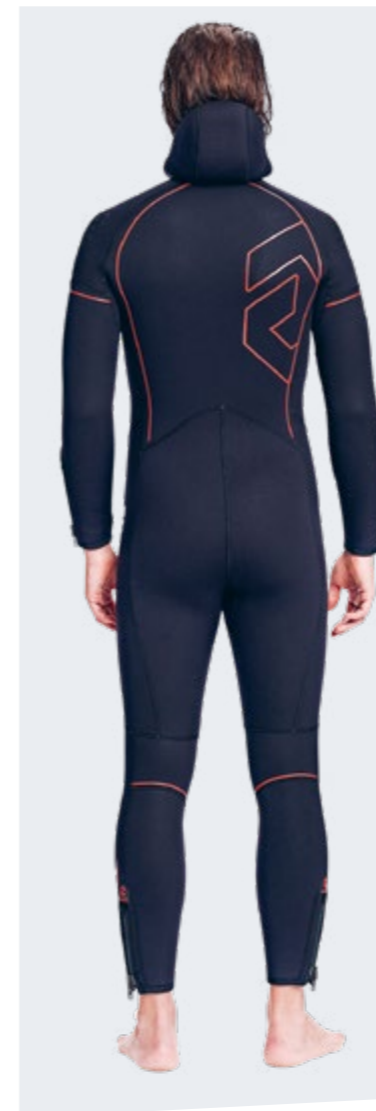
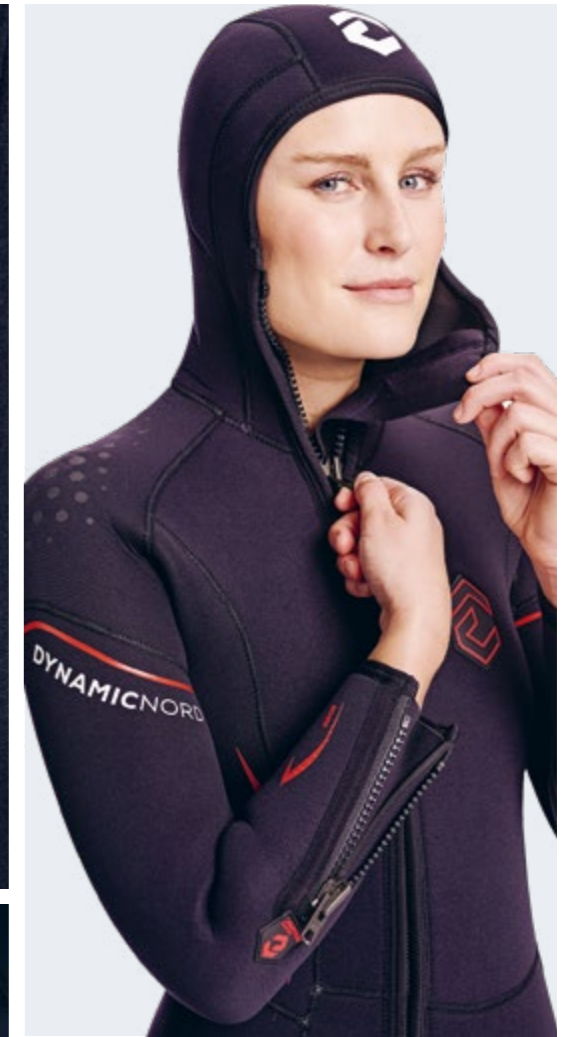

SE-SERIES

Shorties / Fullsuits / with Hood

designed
in germany

OUR STANDARD SERIES



5 THERMAL PROTECTION



SE-21-S

Shorty 2 mm

SE-31

Fallsuit 3 mm

SE-51

Fallsuit 5 mm

SE-51-H

Fallsuit Hood 5 mm

SE-71

Fallsuit 7 mm

SE-71-H

Fallsuit Hood 7 mm

SE-22-S

Shorty 2 mm

SE-32

Fallsuit 3 mm

SE-52

Fallsuit 5 mm

SE-52-H

Fallsuit Hood 5 mm

SE-72

Fallsuit 7 mm

SE-72-H

Fallsuit Hood 7 mm



Also available with hood and front zipper / Reinforced shoulders and knees / Resistant against mechanical abrasion

The shorties are available in 2 mm and the fullsuits in 3 – 7 mm. The back-zipper configuration minimizes the feeling of cold in the wind. The fullsuit with hood and front-zipper is available in 5–7 mm. The neoprene is abrasion resistant and the fullsuits have reinforcements on shoulder and knees.

80% Neoprene / 20% Nylon

designed in germany



Men
black/grey

XS	S	M	ML
L	XL	2XL	3XL



Women
black/grey

XS	S	M	L
XL	2XL	3XL	

For more details see sizechart on page 58/59

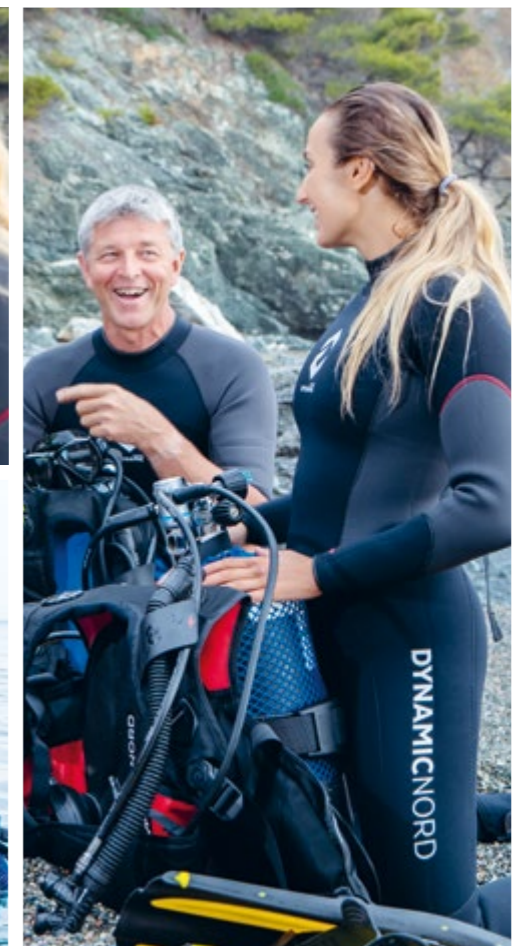



SE-SERIES

Those are the perfect wetsuits for dive centers, schools and dive clubs. The Shorty is available in 2 mm and the others in 3 - 7 mm.



SH-SERIES

Fullsuit

designed
in germany

OUR SKIN PROTECTION



SH-11

Fullsuit 1 mm

Ultra-thin 1 mm neoprene suit is perfect for swimming, snorkeling, or warm water scuba diving. Ideal for any water activity with maximum comfort and safety.

We combined neoprene with nylon in the design for greater comfort and elasticity, offering great freedom of movement

Perfect for swimming, snorkeling, and scuba diving / 1 mm neoprene / Neoprene/nylon combined / Great freedom of movement

Neoprene / Nylon combined

Fullsuit
1 mm

XS	S	M	ML	L
XL	2XL	3XL	4XL	

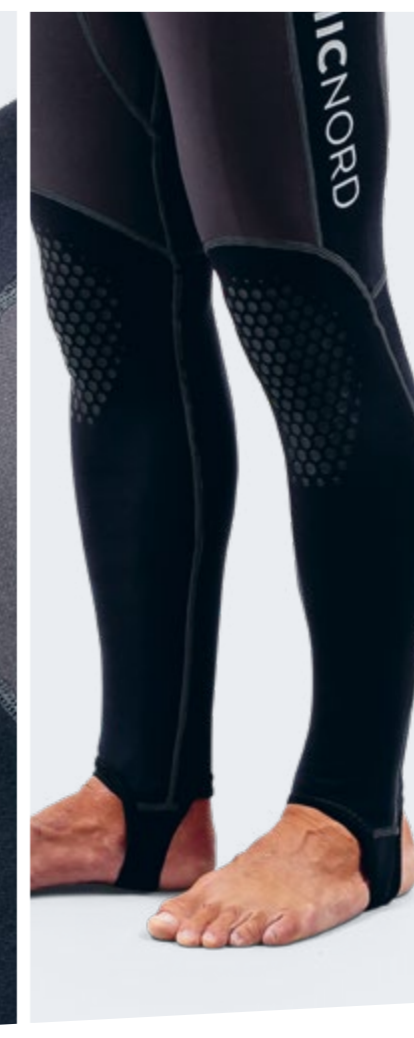

Sizecharts Wetsuits

It's very important that you choose your size carefully.
The wetsuit should fit tightly to the body. The neoprene must always be in contact with the skin because pockets of air bags will make you lose thermal power.

These size charts are valid for 3 mm, 5 mm and 7 mm wetsuits.

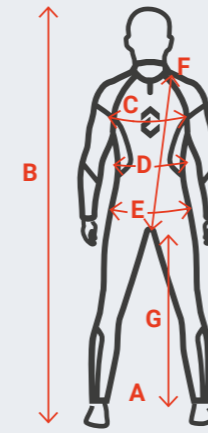

- A. WEIGHT: As close as you can accurately determine
- B. HEIGHT: From the top of your head to the floor
- C. CHEST: The front surface between the neck and the stomach
- D. WAIST: The part below the ribs and above the hips
- E. HIP: The circumference of the body at the buttocks
- F. TORSO: The trunk of the human body
- G. INSEAM: Inside leg. Measure from crotch to floor.

Women	in cm/inch														
Height	157-163 5'2"-5'4"	160-165 5'3"-5'5"	165-170 5'5"-5'7"	163-168 5'4"-5'6"	168-173 5'7"-5'9"	163-168 5'4"-5'6"	165-170 5'5"-5'7"	175-180 5'9"-5'11"	165-170 5'5"-5'7"	168-173 5'6"-5'8"	168-173 5'6"-5'8"	170-175 5'7"-5'9"	170-175 5'7"-5'9"	173-178 5'8"-5'10"	
Chest	76-81 30-32	81-86 32-34	81-86 32-34	86-91 34-36	86-91 34-36	94-99 37-39	91-97 36-38	91-97 36-38	99-104 39-41	97-102 38-40	104-109 41-43	102-107 40-42	109-114 43-45	107-112 42-44	
Waist	58-64 23-25	64-69 25-27	64-69 25-27	69-74 27-29	69-74 27-29	84-89 33-35	74-79 29-31	74-79 29-31	89-94 35-37	79-84 31-33	84-99 37-39	84-89 33-35	99-104 39-41	89-94 35-37	
Hip	84-89 33-35	89-94 35-37	89-94 35-37	94-99 37-39	94-99 37-39	109-114 43-45	99-104 39-41	99-104 39-41	114-119 45-47	104-109 41-43	119-125 47-49	109-114 43-45	125-130 49-51	114-119 45-47	
Inseam	75 29 7/8	77 30 1/2	81 31 3/4	79 31 1/8	84 33	79 31 1/8	81 31 3/4	86 34	81 31 3/4	82 32 3/8	82 32 3/8	84 33	84 33	85 33 5/8	
Size	XS	S	ST *	M	MT *	M+ *	L	LT *	L+ *	XL	XL+ *	2XL	2XL+ *	3XL	

Men	in cm/inch																
Height	157-167 5'2"-5'4"	168-173 5'6"-5'8"	173-178 5'8"-5'10"	180-184 5'11"-6'1"	168-173 5'6"-5'8"	178-183 5'10"-6'0"	183-188 6'0"-6'2"	170-175 5'7"-5'9"	180-185 5'11"-6'1"	185-191 6'1"-6'3"	173-178 5'8"-5'10"	183-188 6'0"-6'2"	188-193 6'2"-6'4"	173-178 5'8"-5'10"	185-191 6'1"-6'3"	188-193 6'2"-6'4"	191-196 6'3"-6'5"
Chest	84-89 33-35	89-94 35-37	94-99 37-39	94-99 37-39	99-104 39-41	99-104 39-41	99-104 39-41	104-109 41-43	104-109 41-43	104-109 41-43	109-114 43-45	109-114 43-45	109-114 43-45	114-119 45-47	114-119 45-47	119-124 47-49	124-129 49-51
Waist	68-74 27-29	74-79 29-31	79-84 31-33	79-84 31-33	84-89 33-35	84-89 33-35	84-89 33-35	89-94 35-37	89-94 35-37	89-94 35-37	94-99 37-39	94-99 37-39	94-99 37-39	99-104 39-41	99-104 39-41	104-109 41-43	109-114 43-45
Hip	86-91 34-36	89-94 35-37	94-99 37-39	94-99 37-39	99-104 39-41	99-104 39-41	99-104 39-41	104-109 41-43	104-109 41-43	104-109 41-43	109-114 43-45	109-114 43-45	109-114 43-45	114-119 45-47	114-119 45-47	119-124 47-49	124-129 49-51
Torso	66 25 7/8	70 27 3/8	72 28 3/8	75 29 5/8	70 27 5/8	75 29 3/8	78 30 5/8	71 28	76 30	79 31 1/4	71 28 1/8	78 30 5/8	81 31 7/8	72 28 1/2	79 31 1/4	81 31 7/8	82 32 3/8
Inseam	72 28 1/2	76 30	79 31	81 32	77 30 1/4	81 32	84 33	77 30 1/2	83 32 1/2	85 33 1/2	79 31	84 33	86 34	79 31 1/4	85 33 1/2	86 34	87 34 1/2
Weight kg lbs	54-63 120-140	61-70 135-155	68-79 150-175	70-82 150-180	72-84 160-185	77-88 170-195	79-91 175-200	82-93 180-205	86-98 190-215	88-100 195-220	91-102 200-225	95-107 210-235	98-109 215-240	100-111 220-245	104-116 230-255	113-125 250-275	122-134 270-295
Size	XS	S	M	MT *	ML Short *	ML	ML Tall *	L Short *	L	L Tall *	XL Short *	XL	XL Tall *	2XL Short *	2XL	3XL	4XL

If you are between some sizes please try the size which is the closest to your measurements.

* not available for SE/SL series



Overview Wetsuits

Overview Wetsuits

Men

SP-51 SP-71	SL-31 SL-51 SL-71	SL-51-H SL-71-H	SE-21-S	SE-31 SE-51 SE-71	SE-51-H SE-71-H	SH-11
5/7 mm	3 mm	5 mm	2 mm	3/5/7 mm	5/7 mm	1 mm
XS S M M Tall ML Short ML ML Tall L Short L L Tall XL Short XL XL Tall 2 XL Short 2 XL 3 XL 4 XL	5 mm 7 mm 	7 mm 	XS S M ML L XL 2 XL 3 XL 4 XL	XS S M ML L XL 2 XL 3 XL 4 XL	XS S M ML L XL 2 XL 3 XL 4 XL	XS S M ML L XL 2 XL 3 XL 4 XL

Women

SP-52 SP-72	SL-32 SL-52 SL-72	SL-52-H SL-72-H	SE-22-S	SE-32 SE-52 SE-72	SE-52-H SE-72-H
5/7 mm	3 mm	5 mm	2 mm	3/5/7 mm	5/7 mm
XS S S Tall M M Tall M+ L L Tall L+ XL XL+ 2 XL 2 XL+ 3 XL	5 mm 7 mm 	7 mm 	XS S M L XL 2 XL 3 XL	XS S M L XL 2 XL 3 XL	XS S M L XL 2 XL 3 XL





DRYSUITS

Our RS drysuit series uses 350 g/m² Ripstop, an anti-tear fabric that incorporates thicker, high-strength threads (nylon) into its weave. It is used in equipment that requires great durability and resistance.

RS-351

Drysuit



350 g/m² Ripstop, anti-tear fabric / **Great durability and resistance** / Pattern allows complete freedom of movement and prevents excess air from moving inside the suit / **TiZip zipper, protected by a flap from the shoulder to the hip** / Inflation valve can be upgraded to connect with electric heated underwear /

Material

350 g/m² Ripstop, anti-tear fabric (20 % Nylon "Ripstop", 60 % Butyl Rubber, 20 % Polyester)
3 mm neoprene neck seal
TiZip zipper

Our RS drysuit series uses 350 g/m² Ripstop, an anti-tear fabric that incorporates thicker, high-strength threads (nylon) into its weave. It is used in equipment that requires great durability and resistance.

The pattern allows complete freedom of movement, making the dive safe and comfortable, and prevents excess air from moving inside the suit. The drysuit seal uses a TiZip zipper, protected by a flap from the shoulder to the hip. Our inflation and exhaust valves are high performance. The inflation valve allows an upgrade to connect a canister for electrically heated underwear. The exhaust valve can be adjusted according to the profile of the dive. The wrist seals are HD bottlenecks and are made of high-strength latex.

XS	S	MS	M	MT	MLS	ML	MLT
LS	L	LT	XLS	XL	XLT	2XLS	2XL
3XL	3XLS	4XL	4XLS				

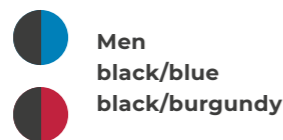

designed
engineered
in germany

RS-352

Drysuit



Wrist seals are HD bottle-necks made of high-strength latex / 3 mm neoprene neck seal / **Two leg pockets can be fitted using the multi-purpose Molle system** / Boots are made of 3 mm double-sided, cross-layered neoprene, with ankle straps, fin stoppers, and a protective but very flexible sole

Material

350 g/m² Ripstop, anti-tear fabric (20 % Nylon "Ripstop", 60 % Butyl Rubber, 20 % Polyester)
3 mm neoprene neck seal
TiZip zipper

The neck seal is made of 3 mm neoprene and gives additional thermal protection in this sensitive area. The 8 mm neoprene hood has an air escape system and keeps your head warm and comfortable. Two leg pockets can be fitted using the multi-purpose Molle system. It is also possible to place different pockets, depending on the profile and needs of the dive.

The double ripstop zones on the elbows, knees, and crotch protect the stress areas but still facilitate freedom of movement, even on very long dives. The boots are made of 3 mm double-sided, cross-layered neoprene, with ankle straps, fin strap stoppers, and a protective but very flexible sole.

XXS	XS	SS	S	MS	M
MT	LS	L	XLS	XL	

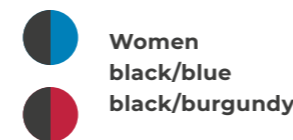

designed
engineered
in germany



Molle System

Molle is a proven, standardized attachment system that is extremely variable and compatible.

Different sized Molle bags and equipment can be attached to the desired position of the Molle carrier and ensure a firm and secure mounting.



Cargo bag with drainage and bungee straps



Fixation through the Molle system



Simple



Secure



Removable and replaceable with an alternative bag or holder



DY-61

dynaskin Fullsuit
Frontzip

DY-62

dynaskin Fullsuit
Frontzip



100% Windproof / **Water repellent** / Highly breathable / **Neutrally buoyant** / Resilient stretch / **Fast drying** / Odor free / **UV protection** / Easy care

The perfect suit to be worn as underwear under a drysuit in cold waters. In the event of flooding, the high-water absorption capacity keeps the skin warm, largely preventing hypothermia. Its high perspiration capacity will always make you feel dry even if you sweat while wearing it. Its front zip provides greater comfort when we proceed to equip ourselves, and also connects the purges for technical divers. Its neutral buoyancy avoids you having to add more ballast, which further aids your comfort and freedom of movement.

It can be used as a single suit in warm waters.

51% Polyester / 37% Nylon
12% Spandex

designed
engineered
in germany



**Men
grey**

S	M	ML
L	XL	2XL 3XL



**Women
grey**

XS	S	M
L	XL	2XL

For more details see sizechart on page 88/89

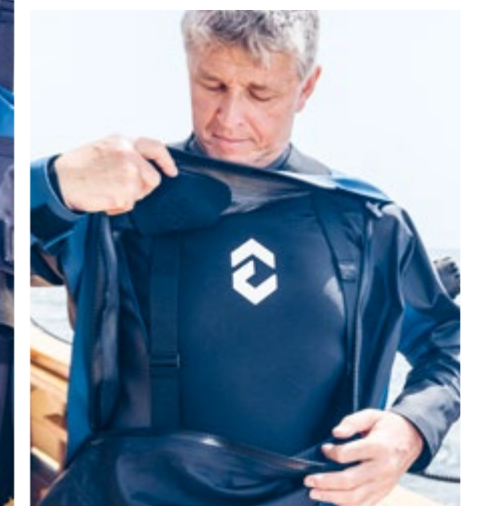
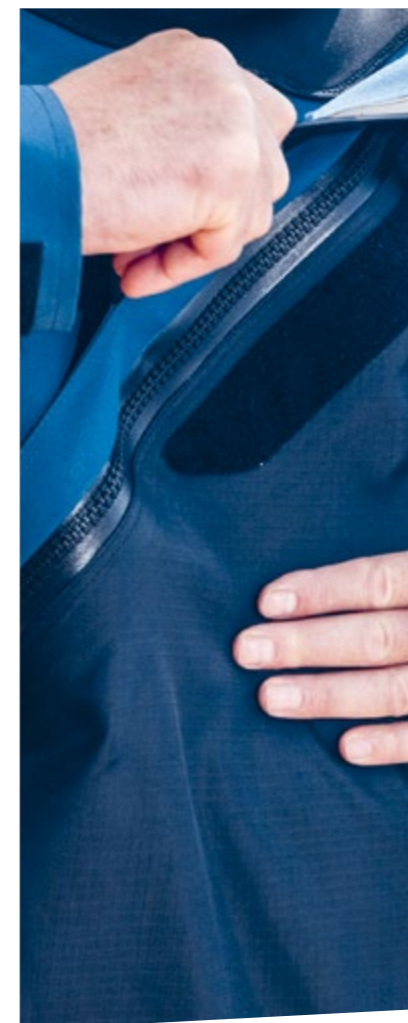
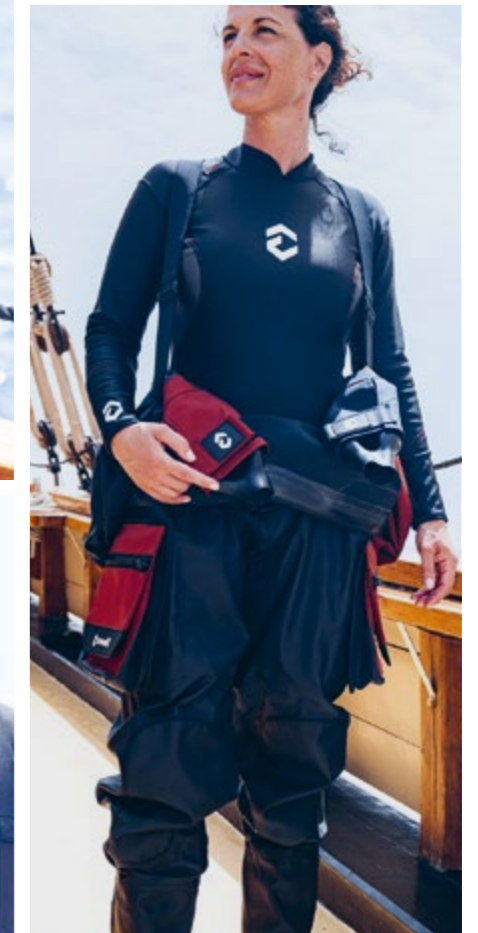
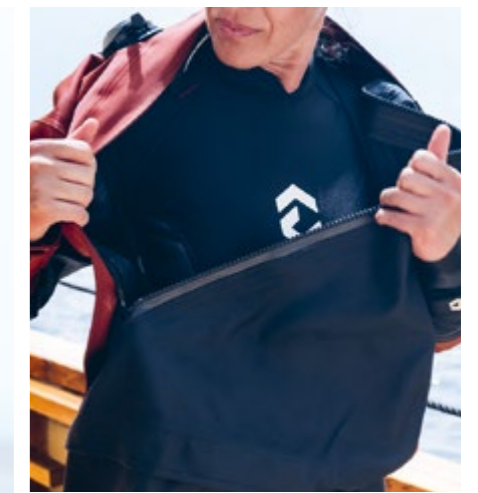

*Images show different Dynaskin models

Sizecharts Drysuits

It's very important that you choose your size carefully.

The drysuit must be comfortable and allow freedom of movement, remaining adapted to the body and avoiding excessive air spaces. It should be kept in mind that during the descent the ambient pressure will compress the suit, and therefore it must be able to regain its comfort with minimum inflation.

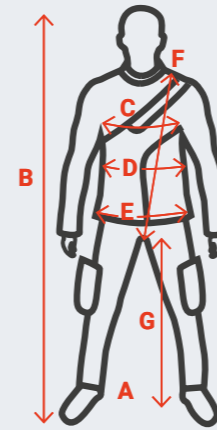

- A. WEIGHT: As close as you can accurately determine
- B. HEIGHT: From the top of your head to the floor
- C. CHEST: The front surface between the neck and the stomach
- D. WAIST: The part below the ribs and above the hips
- E. HIP: The circumference of the body at the buttocks
- F. TORSO: The trunk of the human body
- G. INSEAM: Inside leg. Measure from crotch to floor.

Women	in cm/inch										
Height	152-157 5'-5'2"	161-166 5'3 1/2"-5'5 1/2"	155-160 5'1-5'3"	165-170 5'5"-5'7"	157-162 5'2-5'4"	169-174 5'6 1/2"-5'8 1/2"	176-181 5'9 1/2"-5'11 1/2"	161-166 5'31/2"-5'5 1/2"	173-178 5'8-5'10"	165-170 5'5-5'7"	176+ 5'9 1/2"-5'11 1/2"
Chest	81-89 23-35	81-89 32-35	89-97 35-38	89-97 35-38	97-104 38-41	97-104 38-41	97-104 38-41	104-112 41-44	104-112 41-44	112-119 44-47	112-119 44-47
Waist	58-66 23-26	58-66 23-26	66-74 26-29	66-74 26-29	74-81 29-32	74-81 29-32	74-81 29-32	81-89 32-35	81-89 32-35	89-97 35-38	89-97 35-38
Hips	84-91 33-36	84-91 33-36	91-99 36-39	91-99 36-39	99-107 39-42	99-107 39-42	99-107 39-42	107-114 42-45	107-114 42-45	114-122 45-48	114-122 45-48
Torso	57 22 1/4	59 23 1/4	58 22 3/4	62 24 1/4	58 23	64 25 1/4	67 26 1/2	61 24	67 26 1/4	63 25	69 27 1/4
Inseam	73 28 3/4	79 31 1/4	74 29 1/4	81 31 3/4	76 30	82 32 1/4	86 34	77 30 1/2	83 32 3/4	79 31	84 33 1/4
Weight kg lbs	50-52 100-115	45-57 100-125	50-61 110-135	54-66 120-145	59-70 130-155	64-75 140-165	66-77 145-170	68-80 150-175	73-84 160-185	77-88 170-195	82+ 180+
Size	XS Short	XS	S Short	S	M Short	M	M Tall	L Short	L	XL Short	XL

Men	in cm/inch																			
Height	157-167 5'2"-5'4"	168-173 5'6"-5'8"	165-170 5'5"-5'7"	173-178 5'8"-5'10"	180-184 5'11"-6'1"	168-173 5'6"-5'8"	178-183 5'10"-6'0"	183-188 6'0"-6'2"	170-175 5'7"-5'9"	180-185 5'11"-6'1"	185-191 6'1"-6'3"	173-178 5'8"-5'10"	183-188 6'0"-6'2"	188-193 6'2"-6'4"	173-178 5'8"-5'10"	185-191 6'1"-6'3"	173-178 5'8"-5'10"	188-193 6'2"-6'4"	173-178 5'8"-5'10"	191-196 6'3"-6'5"
Chest	84-89 33-35	89-94 35-37	94-99 37-39	94-99 37-39	94-99 37-39	99-104 39-41	99-104 39-41	99-104 39-41	104-109 41-43	104-109 41-43	104-109 41-43	109-114 43-45	109-114 43-45	109-114 43-45	114-119 45-47	114-119 45-47	119-124 47-49	119-124 47-49	124-129 49-51	124-129 49-51
Waist	68-74 27-29	74-79 29-31	79-84 31-33	79-84 31-33	79-84 31-33	84-89 33-35	84-89 33-35	84-89 33-35	89-94 35-37	89-94 35-37	89-94 35-37	94-99 37-39	94-99 37-39	94-99 37-39	99-104 39-41	99-104 39-41	104-109 41-43	104-109 41-43	109-114 43-45	109-114 43-45
Hips	86-91 34-36	89-94 35-37	94-99 37-39	94-99 37-39	94-99 37-39	99-104 39-41	99-104 39-41	99-104 39-41	104-109 41-43	104-109 41-43	104-109 41-43	109-114 43-45	109-114 43-45	109-114 43-45	114-119 45-47	114-119 45-47	119-124 47-49	119-124 47-49	124-129 49-51	124-129 49-51
Torso	66 25 7/8	70 27 3/8	68 26 7/8	72 28 3/8	75 29 5/8	70 27 5/8	75 29 3/8	78 30 5/8	71 28	76 30	79 31 1/4	71 28 1/8	78 30 5/8	81 31 7/8	72 28 1/2	79 31 1/4	72 28 1/2	81 31 7/8	72 28 1/2	82 32 1/2
Inseam	72 28 1/2	76 30	75 29 1/2	79 31	81 32	77 30 1/4	81 32	84 33	77 30 1/2	83 32 1/2	85 33 1/2	79 31	84 33	86 34	79 31 1/4	85 33 1/2	79 31 1/4	86 34	79 31 1/4	87 34 1/2
Weight kg lbs	54-63 120-140	61-70 135-155	63-75 140-165	68-79 150-175	70-82 150-180	72-84 160-185	77-88 170-195	79-91 175-200	82-93 180-205	86-98 190-215	88-100 195-220	91-102 200-225	95-107 210-235	98-109 215-240	100-111 220-245	104-116 230-255	95-106 240-265	113-125 250-275	118-129 260-285	122-134 270-295
Size	XS	S	M Short	M	M Tall	ML Short	ML	ML Tall	L Short	L	L Tall	XL Short	XL	XL Tall	2XL Short	2XL	3XL Short	3XL	4XL Short	4XL

If you are between some sizes please try the size which is the closest to your measurements.

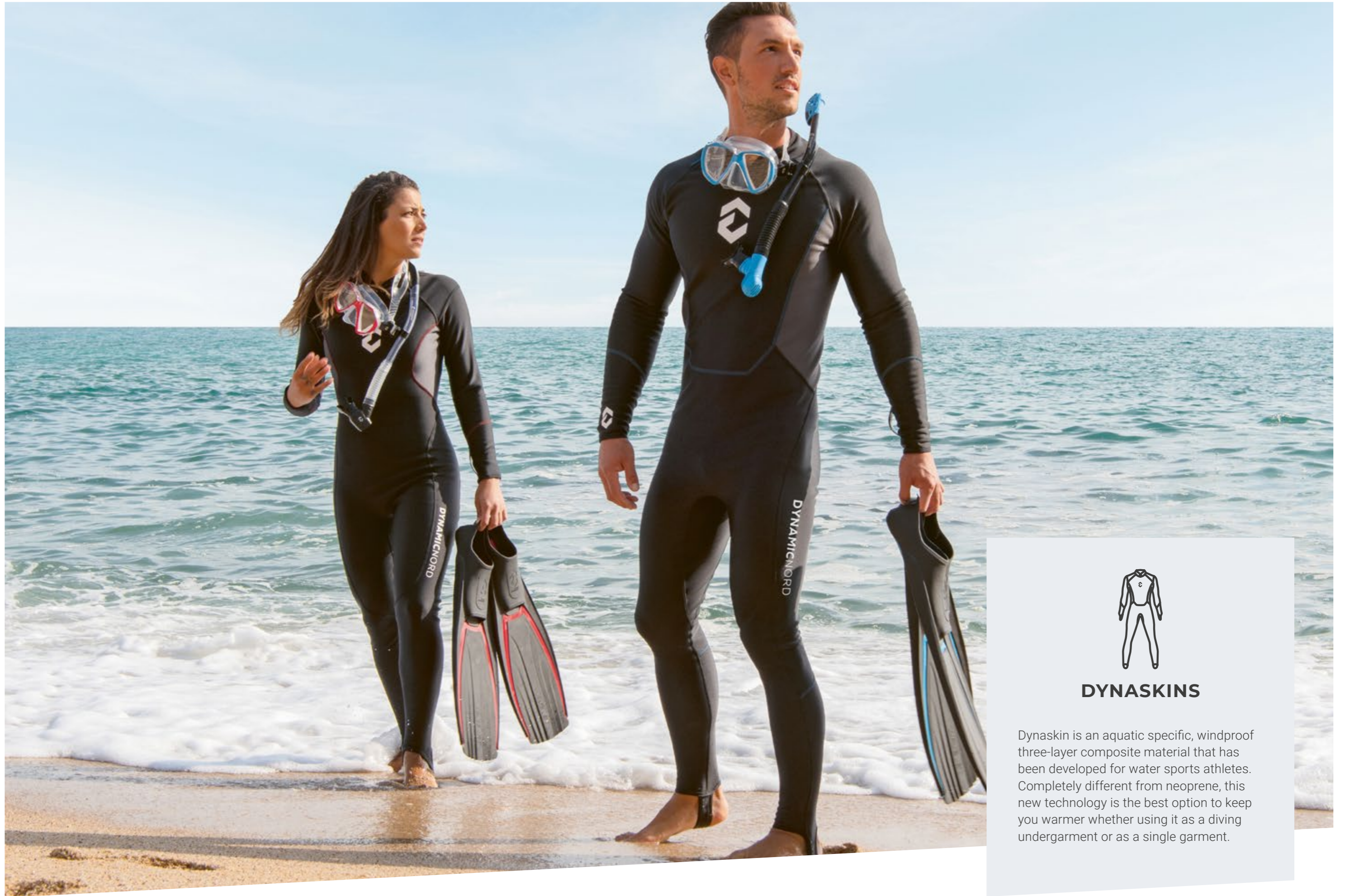

DYNASKINS

Dynaskin is an aquatic specific, windproof three-layer composite material that has been developed for water sports athletes. Completely different from neoprene, this new technology is the best option to keep you warmer whether using it as a diving undergarment or as a single garment.

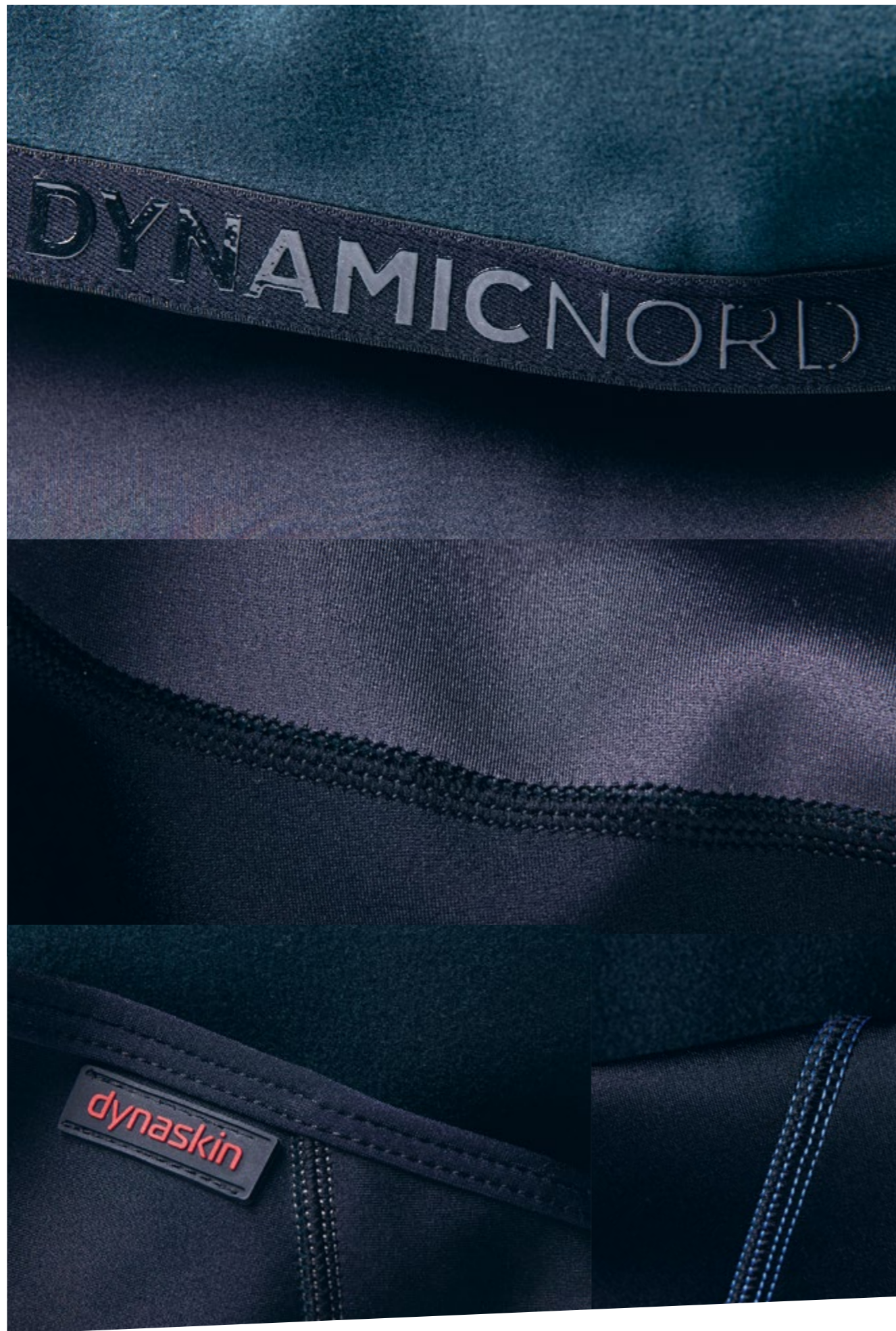

dynaskin

You'll feel dry even if you're wet.

designed
engineered
in germany

Powered by Polartec®, our Dynaskin provides maximum weather protection from wind, water, and cold conditions, acting as your second skin. Its three layers work together, giving incredible results in any weather conditions.

Main features of our dynaskins:



100%
Windproof



Water
repellent



Highly
breathable



Resilient
stretch



Easy care



Fast drying



UV
protection



Odor free



Neutrally
buoyant

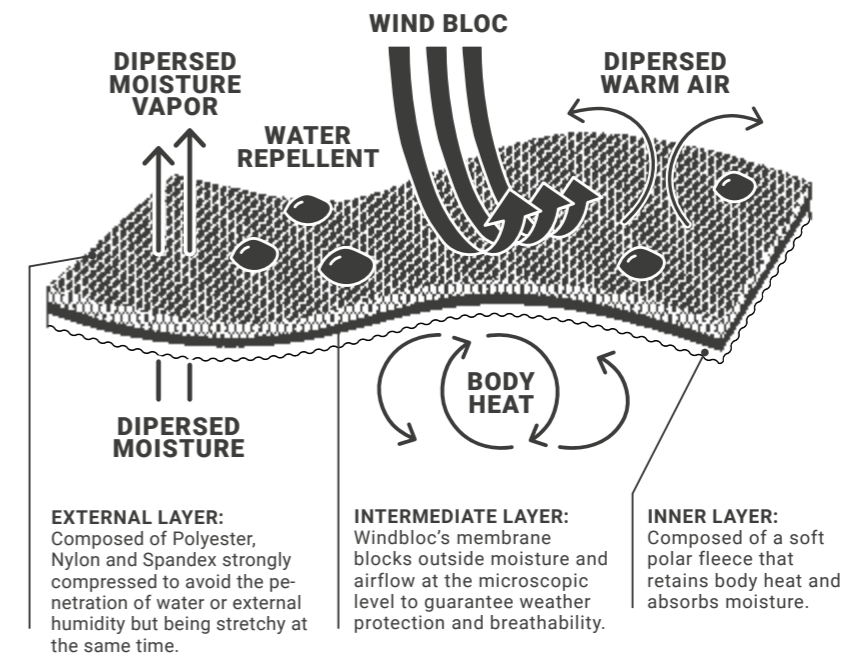

Polartec® Eco-Engineering



Our skins are made with Polartec® technology, and Polartec® commits to 100% recycled materials and biodegradability across its entire product line. Polartec Eco-Engineering™ has set a new standard for sustainable textiles – including the creation of the world's first fully recycled and biodegradable fleece, other knits, insulation fills, and breathable waterproof fabrics. Polartec® recycles 1.5 billion plastic bottles, adding up to its worldwide production.



designed
engineered
in germany



DYNAMICNORD

dynaskin*

You'll feel dry even if you're wet.

* dynaskin is a brand by DYNAMICNORD

DY-11

dynaskin Fullsuit 3 mm

DY-12

dynaskin Fullsuit 3 mm



100% Windproof / **Water repellent** / Highly breathable / **Neutrally buoyant** / Resilient stretch / **Fast drying** / Odor free / **UV protection** / Easy care

Perfect for warm water dives, the one-piece suit will provide you with great comfort while diving thanks to its neutral buoyancy. Softer and more elastic fabric than neoprene, it will also provide you with great freedom of movement both during the dive and on the surface. Resistant to UV rays, moisture odors, and quick drying, it's the perfect suit if you're travelling in tropical areas. Its low weight and flexibility make it ideal for taking up little space when preparing your travel suitcase, where weight and space are essential.

It can be used as an undergarment under a drysuit.

51% Polyester / 37% Nylon
12% Spandex

designed
engineered
in germany



**Men
black**

S	M	ML	
L	XL	2XL	3XL



**Women
black**

XS	S	M
L	XL	2XL

For more details see sizechart on page 88/89

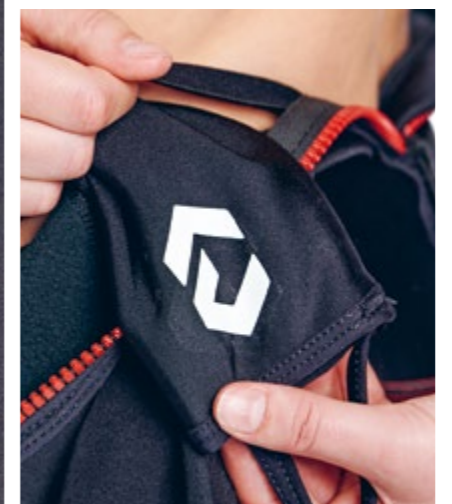
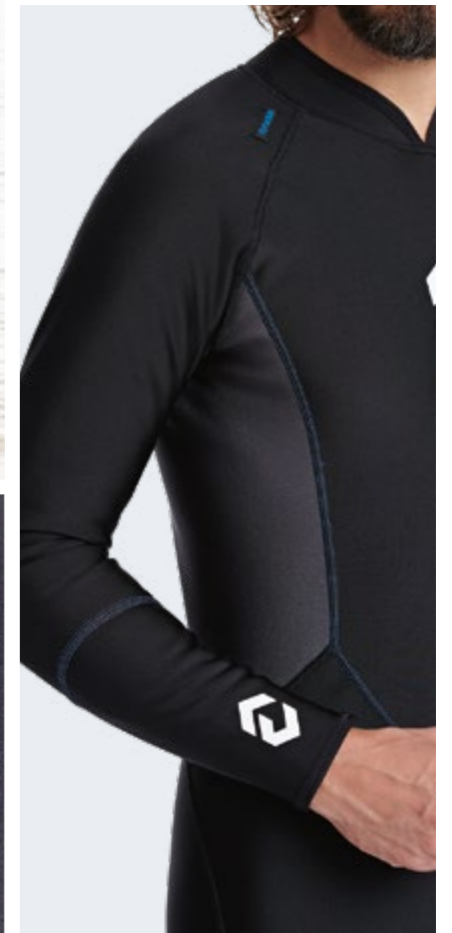
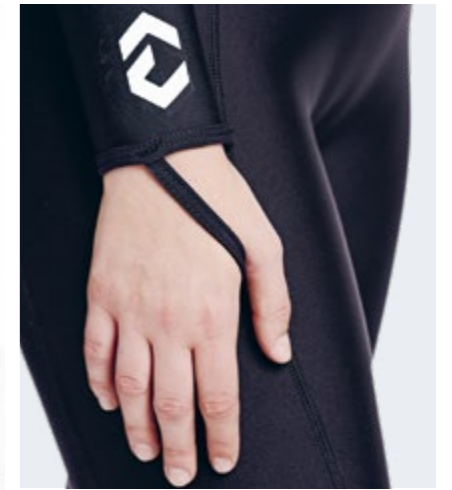

DY-61

dynaskin Fullsuit
Frontzip



DY-62

dynaskin Fullsuit
Frontzip



100% Windproof / **Water repellent** / Highly breathable / **Neutrally buoyant** / Resilient stretch / **Fast drying** / Odor free / **UV protection** / Easy care

The perfect suit to be worn as underwear under a drysuit in cold waters. In the event of flooding, the high-water absorption capacity keeps the skin warm, largely preventing hypothermia. Its high perspiration capacity will always make you feel dry even if you sweat while wearing it. Its front zip provides greater comfort when we proceed to equip ourselves, and also connects the purges for technical divers. Its neutral buoyancy avoids you having to add more ballast, which further aids your comfort and freedom of movement.

It can be used as a single suit in warm waters.

The perfect suit to be worn as underwear under a drysuit in cold waters. In the event of flooding, the high-water absorption capacity keeps the skin warm, largely preventing hypothermia. Its high perspiration capacity will always make you feel dry even if you sweat while wearing it. Its front zip provides greater comfort when we proceed to equip ourselves, and also connects the purges for technical divers. Its neutral buoyancy avoids you having to add more ballast, which further aids your comfort and freedom of movement.

It can be used as a single suit in warm waters.

100% Windproof / **Water repellent** / Highly breathable / **Neutrally buoyant** / Resilient stretch / **Fast drying** / Odor free / **UV protection** / Easy care

51% Polyester / 37% Nylon
12% Spandex

Men grey

S	M	ML
L	XL	2XL 3XL

designed
engineered
in germany

For more details see sizechart on page 88/89

51% Polyester / 37% Nylon
12% Spandex

Women grey

XS	S	M
L	XL	2XL

designed
engineered
in germany

For more details see sizechart on page 88/89





DY-21
dynaskin Shirt Short

DY-41
dynaskin Pants Short

DY-22
dynaskin Shirt Short

DY-42
dynaskin Pants Short

100% Windproof / **Water repellent** / Highly breathable / **Neutrally buoyant** / Resilient stretch / **Fast drying** / Odor free / **UV protection** / Easy care

The short sleeve shirt can be used as a single garment or in combination with a neoprene or trilaminate suit. Its high thermal capacity combined with its neutral buoyancy make it the ideal accessory for use as underwear under a wet, semi-dry or drysuit. Its windproof, anti-splash water and UV protection features also make it perfect for any surface sport. The short pants are the ideal complement to the long and/or short sleeve shirts. Perfect for use as a two-piece undergarment under a neoprene suit. They maintain the same thermal capacity and neutral buoyancy as other Dynaskin products. The superb windproof, anti-splash water and UV protection capabilities make them perfect for any surface sport.

51% Polyester / 37% Nylon
12% Spandex

designed
engineered
in germany

● Men Shirt & Pants	S	M	ML
	L	XL	2XL 3XL
● Women Shirt & Pants	XS	S	M
	L	XL	2XL

For more details see sizechart on page 88/89

DY-10
dynaskin Hood



DY-20
dynaskin Socks



100% Windproof / **Water repellent** / Highly breathable / **Neutrally buoyant** / Resilient stretch / **Fast drying** / Odor free / **UV protection** / Easy care

In contrast to neoprene hoods, the Dynaskin hood provides a high level of comfort, thanks to its design and soft inner fabric, avoiding the tackling of the ears and facilitating its placement both on the surface and under water. Thermal socks can be worn directly with full foot fins or inside the boots. Their inner polar fabric will keep your feet warm. Their external composition is highly resistant to accidental rubbing, and anti-humidity technology minimizes odors and facilitates rapid drying.

51% Polyester / 37% Nylon
12% Spandex

designed
engineered
in germany

● Hood	S	M
	L	XL
● Socks	S	M
	L	XL

For more details see sizechart on page 101



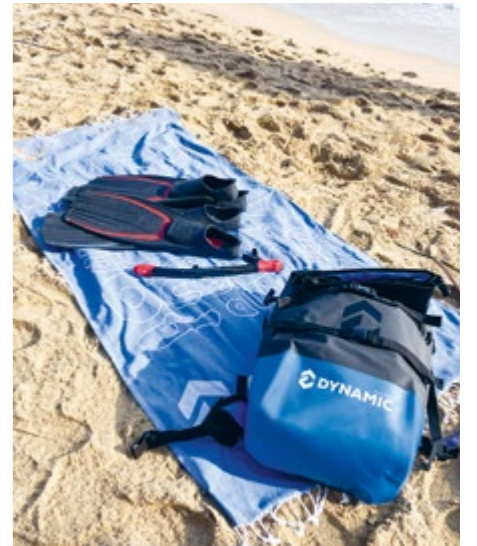

DY-31
dynaskin Shirt Long

DY-51
dynaskin Pants Long

DY-32
dynaskin Shirt Long

DY-52
dynaskin Pants Long



100% Windproof / **Water repellent** / Highly breathable / **Neutrally buoyant** / Resilient stretch / **Fast drying** / Odor free / **UV protection** / Easy care

The long sleeve shirt can be used as a single garment or in combination with a neoprene or trilaminate suit. Its high thermal capacity combined with its neutral buoyancy make it the ideal accessory for use as underwear under a wet, semi-dry or drysuit. Its windproof, anti-splash water and UV protection features also make it perfect for any surface sport.
The long pants are the ideal complement to the long and/or short sleeve shirts. Perfect for use as a two-piece undergarment under a neoprene or trilaminate suit. They maintain the same thermal capacity and neutral buoyancy as other Dynaskin products. The superb windproof, anti-splash water and UV protection capabilities make them perfect for any surface sport.

51% Polyester / 37% Nylon
12% Spandex

designed
engineered
in germany



**Men
Shirt & Pants**

S	M	ML	
L	XL	2XL	3XL



**Women
Shirt & Pants**

XS	S	M
L	XL	2XL

For more details see sizechart on page 88/89



Overview dynaskins



Men



DY-11	DY-61	DY-31	DY-21	DY-51	DY-41
Fullsuit	Fullsuit Frontzip	Shirt Long	Shirt Short	Pants Long	Pants Short
51% Polyester 37% Nylon 12% Spandex	51% Polyester 37% Nylon 12% Spandex	51% Polyester 37% Nylon 12% Spandex	51% Polyester 37% Nylon 12% Spandex	51% Polyester 37% Nylon 12% Spandex	51% Polyester 37% Nylon 12% Spandex
● Black	● Grey	● Black	● Black	● Black	● Black
S XL M 2 XL ML 3 XL L	S XL M 2 XL ML 3 XL L	S XL M 2 XL ML 3 XL L	S XL M 2 XL ML 3 XL L	S XL M 2 XL ML 3 XL L	S XL M 2 XL ML 3 XL L

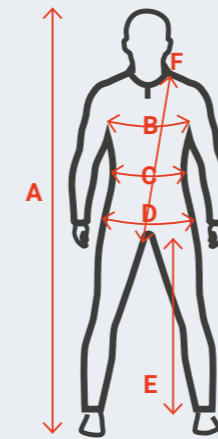

- A. HEIGHT:** From the top of your head to the floor
- B. CHEST:** The front surface between the neck and the stomach
- C. WAIST:** The part below the ribs and above the hips
- D. HIP:** The circumference of the body at the buttocks
- E. INSEAM:** Inside leg. Measure from crotch to floor
- F. TORSO:** The trunk of the human body

Choose a size that gives you comfort and freedom of movement. In the case of Skins, keep in mind that their thermal power resides in their thermal tissue and must be in contact with the skin; therefore, Skins must be adjusted to the body.

Women	in cm/inch						
Height	157-163 5'2"-5'4"	160-165 5'3"-5'5"	163-168 5'4"-5'6"	165-170 5'5"-5'7"	168-173 5'6"-5'8"	170-175 5'7"-5'9"	173-178 5'8"-5'10"
Chest	76-81 30-32	81-86 32-34	86-91 34-36	91-97 36-38	97-102 38-40	102-107 40-42	107-112 42-44
Waist	58-64 23-25	64-69 25-27	69-74 27-29	74-79 29-31	79-84 31-33	84-89 33-35	89-94 35-37
Hips	84-89 33-35	89-94 35-37	94-99 37-39	99-104 39-41	104-109 41-43	109-114 43-45	114-119 45-47
Inseam	75 29 7/8	77 30 1/2	79 31 1/8	81 31 3/4	82 32 3/8	84 33	85 33 5/8
Size	XS	S	M	L	XL	2 XL	3 XL



Women

DY-10	Hoods / Unisex	DY-20	Socks / Unisex
	51% Polyester 37% Nylon 12% Spandex ● S/M/L/XL		51% Polyester 37% Nylon 12% Spandex ● S/M/L/XL



DY-12	DY-62	DY-32	DY-22	DY-52	DY-42
Fullsuit	Fullsuit Frontzip	Shirt Long	Shirt Short	Pants Long	Pants Short
51% Polyester 37% Nylon 12% Spandex	51% Polyester 37% Nylon 12% Spandex	51% Polyester 37% Nylon 12% Spandex	51% Polyester 37% Nylon 12% Spandex	51% Polyester 37% Nylon 12% Spandex	51% Polyester 37% Nylon 12% Spandex
● Black	● Grey	● Black	● Black	● Black	● Black
XS L S XL M 2 XL	XS L S XL M 2 XL	XS L S XL M 2 XL	XS L S XL M 2 XL	XS L S XL M 2 XL	XS L S XL M 2 XL

Men	in cm/inch									
Height	157-167 5'2"-5'4"	168-173 5'6"-5'8"	173-178 5'8"-5'10"	178-183 5'10"-6'0"	180-185 5'11"-6'1"	183-188 6'0"-6'2"	185-191 6'1"-6'3"	188-193 6'2"-6'4"	191-196 6'3"-6'5"	
Chest	84-89 33-35	89-94 35-37	94-99 37-39	99-104 39-41	104-109 41-43	109-114 43-45	114-119 45-47	119-124 47-49	124-129 49-51	
Waist	68-74 27-29	74-79 29-31	79-84 31-33	84-89 33-35	89-94 35-37	94-99 37-39	99-104 39-41	104-109 41-43	109-114 43-45	
Hips	86-91 34-36	89-94 35-37	94-99 37-39	99-104 39-41	104-109 41-43	109-114 43-45	114-119 45-47	119-124 47-49	124-129 49-51	
Torso	66 25 7/8	70 27 3/8	72 28 3/8	75 29 3/8	76 30	78 30 5/8	79 31 1/4	81 31 7/8	82 32 3/8	
Inseam	72 28 1/2	76 30	79 31	81 32	83 32 1/2	84 33	85 33 1/2	86 34	87 34 1/2	
Weight kg lbs	54-63 120-140	61-70 135-155	68-79 150-175	77-88 170-195	86-98 190-215	95-107 210-235	104-116 230-255	113-125 250-275	122-134 270-295	
Size	XS	S	M	ML	L	XL	2 XL	3 XL	4 XL	

If you are between some sizes please try the size which is the closest to your measurements.



RASHGUARDS

High quality fabric for men and women. Thin, breathable and with a high UV protection factor (50+). Allows complete freedom of movement while maximising comfort thanks to its anatomical pre-shaped patterns and flat seams. Quick drying, our rashguards are perfect for warm places.

RG-21

Rashguard Short Sleeve



RG-22

Rashguard Short Sleeve

92

RG-31

Rashguard Long Sleeve



RG-32

Rashguard Long Sleeve

UV protection 50+ /
Breathable / Quick drying /
Flat seams / Anatomic
preshaped patterns

High quality fabric for men and women. Thin, breathable and with a high UV protection factor (50+). Allows for complete freedom of movement while maximizing comfort thanks to its anatomical pre-shaped patterns and flat seams. Quick drying, our Rashguards are perfect for warm places.

20 % Spandex / 43 % Nylon
37 % Polyester

designed
in germany



Men
black/blue

XS	S	M	ML	
L	XL	2XL	3XL	4XL



Women
black/purple

XS	S	M	
L	XL	2XL	3XL

For more details see sizechart on page 88/89





NEOPRENE ACCESSORIES

Hoods, gloves and booties. Everything you need to stay warm and comfortable in any climate and diving conditions. Sustainable manufacturing.

BS-30

Boots 3 mm



Limestone neoprene

designed
in germany

Short 3 mm neoprene boots ideal for warm water. Reinforced toe, instep, and heel for added protection. The rubber block on the heel prevents slippage of the fin strap. The moulded rubber soles are very durable and slip resistant and protect feet from sharp rocks and steep surfaces.

Neoprene, Nylon,
Rubber Sole



Unisex
black

2XS	XS	S	M
L	XL	2XL	3XL



THERMAL PROTECTION

97



BR-50

Boots 5 mm

BR-70

Boots 7 mm



Limestone neoprene

designed
in germany

5 mm or 7 mm limestone bifurcated neoprene boots to protect you from the cold and for a perfect fit with the fin. Reinforced toe, instep and heel for added protection. The rubber block on the heel prevents slippage of the fin strap. The moulded rubber soles are very durable and slip resistant and protect feet from sharp rocks and steep surfaces.

Neoprene, Nylon,
Rubber Sole



Unisex
black

2XS	XS	S	M
L	XL	2XL	3XL



For more details see sizechart on page 101

BG-50
Boots 5 mm
BG-70
Boots 7 mm



designed
in germany



Limestone neoprene

5 mm or 7 mm limestone bifurcated neoprene boots to protect you from the cold and for a perfect fit with the fin. These boots have a rigid 5 mm sole and a zip on the inside side with a safety lock. Reinforced toe, instep, and heel offer greater protection. The rubber heel block prevents slipping of the fin strap. The moulded rubber soles are very strong and anti-slip and protect the feet from sharp rocks and steep surfaces.

Neoprene, Nylon,
Rubber Sole

● **Unisex black** 2XS XS S M
 L XL 2XL 3XL

GL-20
Gloves 1.5 mm



designed
in germany



Limestone neoprene

1.5 mm neoprene gloves to protect you from cold, the abrasions and cuts during the dive. Comfortable and very light for use in warm water. Palm, tips and inside of fingers reinforced for better resistance and excellent grip. Closure by means of leatherette flap with Velcro.

Neoprene and Amara

● **Unisex black** S M
 L XL

SO-20
Socks 2 mm



designed
in germany



Limestone neoprene

2 mm neoprene socks to be worn directly with full foot fins. The rubberized sole is elastic and non-slip, ideal for walking on boat decks and also offers some thermal protection. All seams are glued and stitched for strength and durability.

Neoprene, Rubber Sole

● **Unisex black** 2XS XS S M
 L XL 2XL 3XL

GL-30
Gloves 3 mm
GL-50
Gloves 5 mm



designed
in germany



Limestone neoprene

3 mm and 5 mm limestone neoprene gloves to protect you from cold, abrasions and cuts during the dive. Comfortable and perfect for cold waters. Palm, tips, and inside of fingers reinforced for better resistance and excellent grip.

Neoprene and grip
improving coating

● **Unisex black** S M
 L XL

HO-30

Hood 3 mm

HO-50

Hood 5 mm

HO-80

Hood 8 mm



designed
in germany



Limestone neoprene

3 mm, 5 mm, or 8 mm limestone neoprene hood to prevent heat loss and protect against accidental impacts during the dive.

Neoprene

Unisex
black

S	M
L	XL

CS-10

Cargoshorts



These shorts are designed with two large pockets and can be worn over a wetsuit, a semi-dry, or drysuit. They can also be used as swim shorts in warm water. They are made of 2 mm neoprene mixed with elastic Nylon material. They have two large pockets with bungee straps, flaps, and Velcro for a secure fastening. The waist is adjusted using a Nylon belt with a quick-release buckle. They can be used in many water sports, such as jet skiing or paddling. Their pockets can hold all kinds of safety accessories and spare parts, as well as personal items.



Limestone neoprene

Neoprene mixed with nylon

Unisex
black

S	M	ML
L	XL	2XL



Sizecharts

Socks / Boots / Gloves / Hoods



Choose the size that best fits your foot and is most comfortable. By using the right size, you will not lose power and you will avoid overloading your muscles when kicking.

Unisex	in cm/inch									
Foot Length	22 8 2/3	23 9	24 9 1/2	25 9 7/8	26 10 1/4	27 10 2/3	28 11	29 11 1/2	30 11 7/8	31 12 1/4
Size	3XS	2XS	XS	S	M	L	XL	2XL	3XL	4XL



PALM:
A. Measure palm circumference and
B. palm length

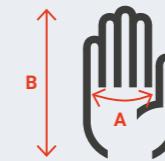

More than 25% of body heat is lost through the head and extremities. It's important that your glove is fully fitted to your hand without leaving space for water circulation.

Unisex	in cm/inch						
Palm Circumference	16,5 - 18 6.5 - 7	17 - 18,5 6.75 - 7.25	18,5 - 19,5 7.25 - 7.75	19,5 - 21 7.75 - 8.25	20,5 - 21,5 8 - 8.5	21,5 - 23 8.5 - 9	22 - 23,5 8.75 - 9.25
Palm Length	16,5 - 18 6.5 - 7	17 - 18,5 6.75 - 7.25	18 - 19 7 - 7.5	19 - 20,5 7.5 - 8	19,5 - 21 7.75 - 8.25	20,5 - 21,5 8 - 8.5	21 - 22 8.25 - 8.75
Size	2XS	XS	S	M	L	XL	2XL



A. FOREHEAD:
Start in the center, front, and measure
around the widest part
B. NECK:
Start in the center, front, and measure
around the middle of the neck

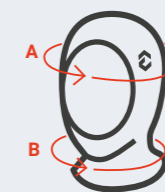

More than 25% of body heat is lost through the head and extremities. It's important that your hood is fully fitted to your head without leaving space for water circulation.

Unisex	in cm/inch					
Forehead	53 21	54,5 21.5	57 22.5	59,5 23.5	61 24	62,5 24.5
Neck	35 13	35,5 14	38 15	40,5 16	43 17	45,5 18
Size	XS	S	M	L	XL	2XL



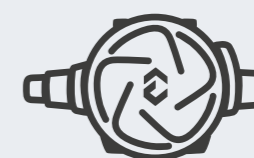

REGULATORS

Our breathing tool. Three different product levels depending on your needs, expectations and budget. Entry, Mid-Range and High-End levels. Quality of breathing and beautiful design. Octopus available. Sustainable manufacturing.



Development Design Function

With our designs for the first and second stages, we have developed a product range that meets all technical requirements and at the same time clearly shows your affiliation to the **DYNAMICNORD** product family. From the simple regulator for diving schools, to the professional device for technical diving, with compensated second stage and freezing protection in the first stage.

All of them have a reduced exhalation work due to an optimized membrane and bubble deflector.

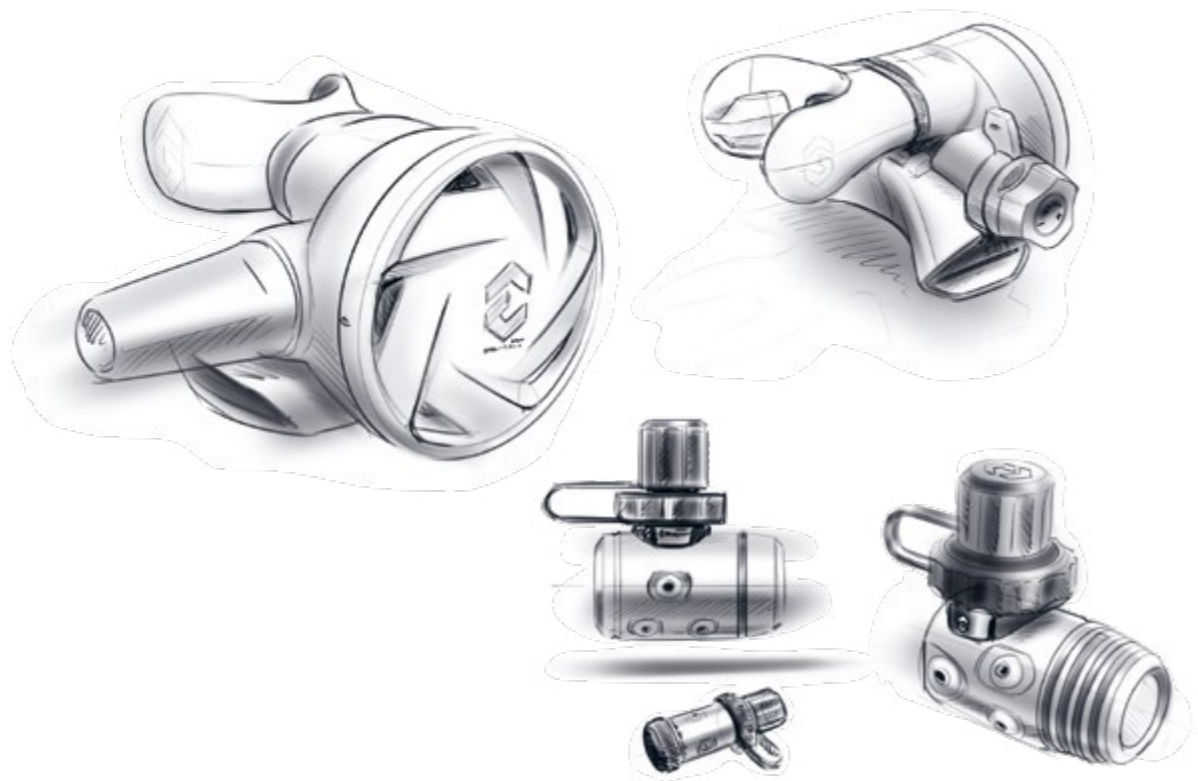

Mouthpiece

Our mouthpiece is also our own development and made of anti-allergic silicone. It guarantees a firm and comfortable fit in the jaw and can be changed in just a few steps if necessary. It is also available as a spare part in specialized shops.



Bubble deflector

Our bubble deflector is a step up from the previous standard. It directs gas bubbles away from their field of vision, but in conjunction with our enlarged exhalation membrane, it also lowers exhalation work, increasing the overall breathing comfort of our second stages.



TR-80
THE TEC REG



IR-50
THE ADVANCED



CS-30
THE WORKHORSE





TR-80

Regulator 1st + 2nd Stage
DIN / INT

THE TEC REG

Connection: DIN 300 bar or INT 232 bar / **Sandblasted brass, matte chrome finish** / Ports: 2 HP 7/16UNF, 4 LP 3/8 UNF / **Membrane compensated design including dry sealing of the first stage** / Emission of cold reduced by the dry sealing / **Adjustable Venturi to prevent free flow on the surface and to reduce inhalation effort during the dive** / Adjustment knob to select your personal inhalation comfort / **Exhaust valve and cover offers minimum resistance** / LP hose tested for a maximum pressure of 34 bar / **Front cover is designed to prevent free flow in strong currents** / Mouthpiece made of high-end silicone / **Average breathing work for complete regulator: 0.86 J/L**

For the most demanding divers in terms of reliability, performance and capabilities. The compensated membrane design includes dry sealing of the first stage. Its structural design of solid for brass makes it ideal to minimize the emission of cold. This structural thickness is important for delaying any possible freezing of the first stage. This feature is even more important for preventing the first stage from freezing during the dive. The second stage is recommended for technical divers in high-level dives. The adjustable Venturi (dive/pre-dive) has been prioritized in its design to prevent freeflow on the surface and to reduce inhalation effort during the dive. The adjustment knob allows you to set your personal inhalation comfort. To provide comfortable and easy exhalation, the exhaust valve and cover offers minimum resistance, and the deflector has been designed to reduce bubbles on the diver's face. The LP hose is tested for a maximum pressure of 34 bar. The mouthpiece is made of high-end anti-allergic silicone for maximum comfort. The breathing work of the first and second stage TR-80 is an average of 0.86 J/L.

Certified for diving in waters below 10°C.
CE certified according the latest standards.

designed
engineered
in germany

TR-81 DIN



TR-82 INT

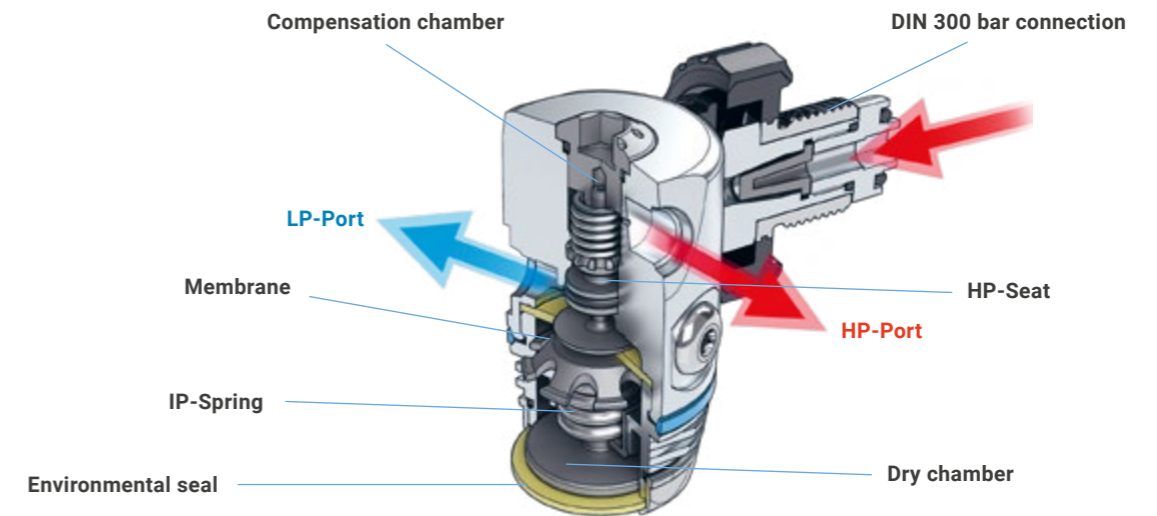

TR-80
THE TEC REG

INHALATION

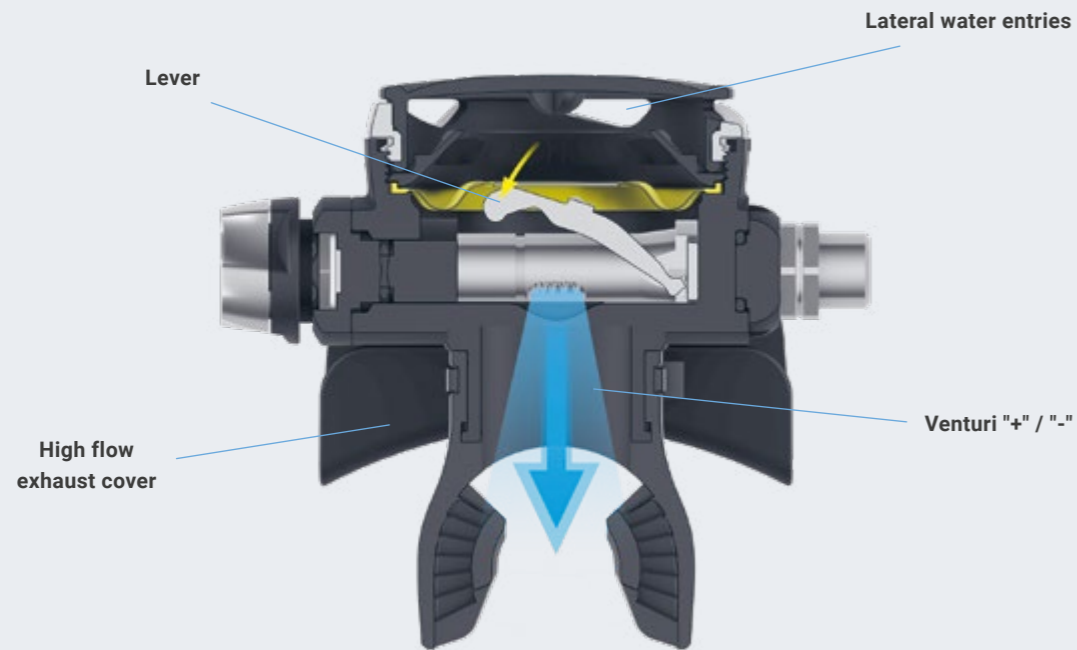

EXHALATION

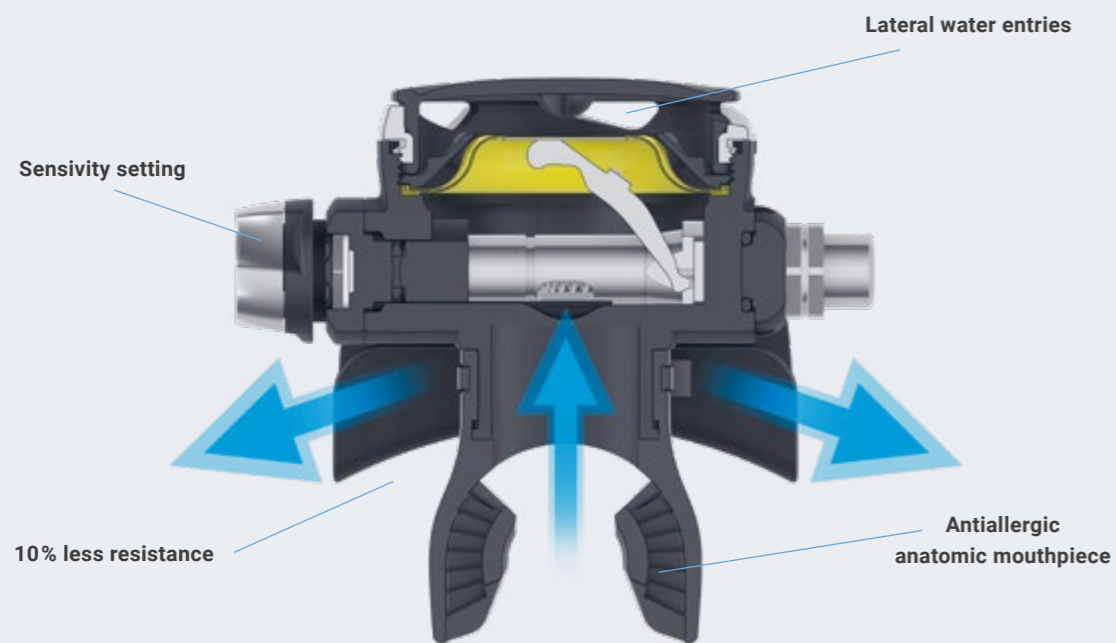

Frontcover TR-80:

This special design of the front cover prevents unwanted blow-off of the second stage when diving with strong currents or with strong fast scooters. The dynamic pressure cannot affect the inhalation membrane because the front cover has no water inlet openings at the front. The necessary inlets are located on the side, allowing the ambient pressure to act on the inhalation membrane and ensure correct operation.

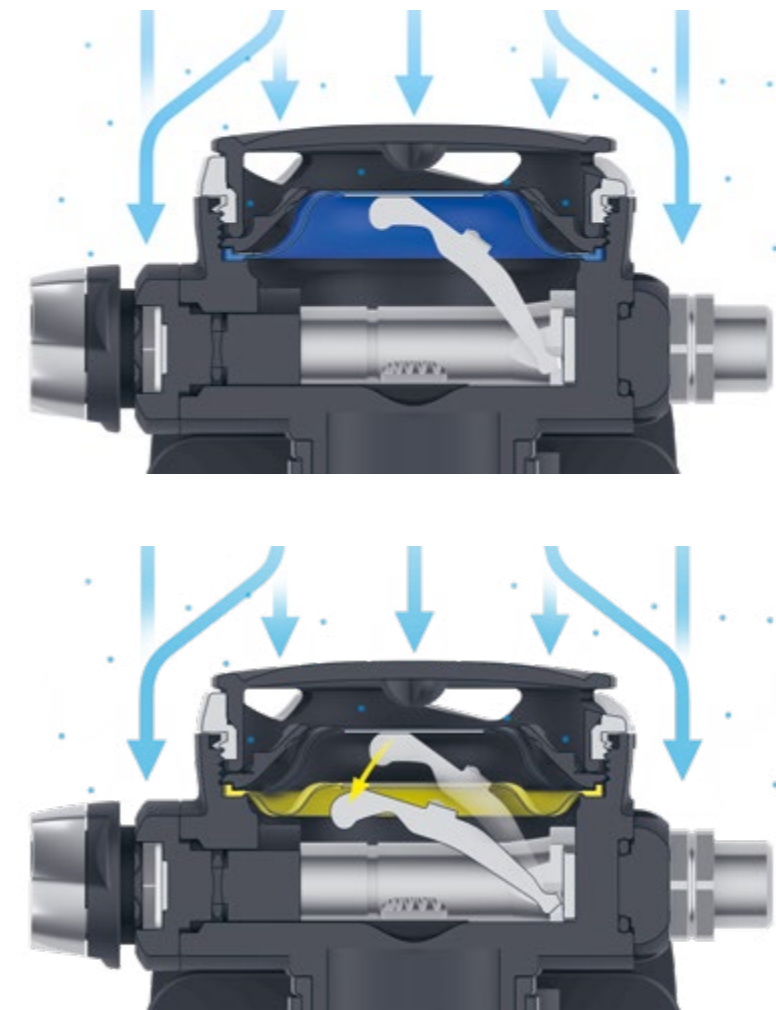

Compensated second stage:

The compensation of the second stage ensures that regardless of the residual pressure in the cylinder, your inhalation comfort remains comfortable.

1 Controllable Venturi Effect:

By setting this to "-", the Venturi effect is attenuated so that the second stage does not unintentionally blow off on land.

Under water, the Venturi effect is then increased on the "+" setting, allowing for easy and comfortable inhalation.

2 Response Resistance Adjustment:

Every diver has a personal perception of the "optimal" inhalation resistance. Using the adjustment knob, everyone finds the best personal setting and thus maximum breathing comfort.



IR-50

Regulator 1st + 2nd Stage
DIN / INT

THE ADVANCED

Connection: DIN 300 bar or INT 232 bar / **Sandblasted brass, matte chrome finish** / Ports: 2 HP 7/16UNF, 4 LP 3/8 UNF / **Membrane compensated** / CE certified according to the latest standards / **Adjustable Venturi to prevent free flow on the surface and to reduce inhalation effort during the dive** / Adjustment knob to select your personal inhalation comfort / **Exhaust valve and cover offers minimum resistance** / LP hose tested for a maximum pressure of 34 bar / **Mouthpiece made of high-end silicone** / Average breathing work for complete regulator: 0.84 J/L

Suitable for advanced and experienced divers.

With a compensated membrane design, it allows deeper dives providing more natural breathing. Certified for diving in waters below 10°C and suitable for depths below 30 m. The adjustable Venturi (dive/pre-dive) has been prioritized in its design to prevent free flow on the surface and to reduce inhalation effort during the dive. The adjustment knob allows you to set your personal inhalation comfort. To provide comfortable and easy exhalation, the exhaust valve and cover offers minimum resistance, and the deflector has been designed to reduce bubbles on the diver's face. The LP hose is tested for a maximum pressure of 34 bar. The mouthpiece is made of high-end anti-allergic silicone for maximum comfort. The breathing work of the first and second stage IR-50 is an average of 0.84 J/L.

designed
engineered
in germany

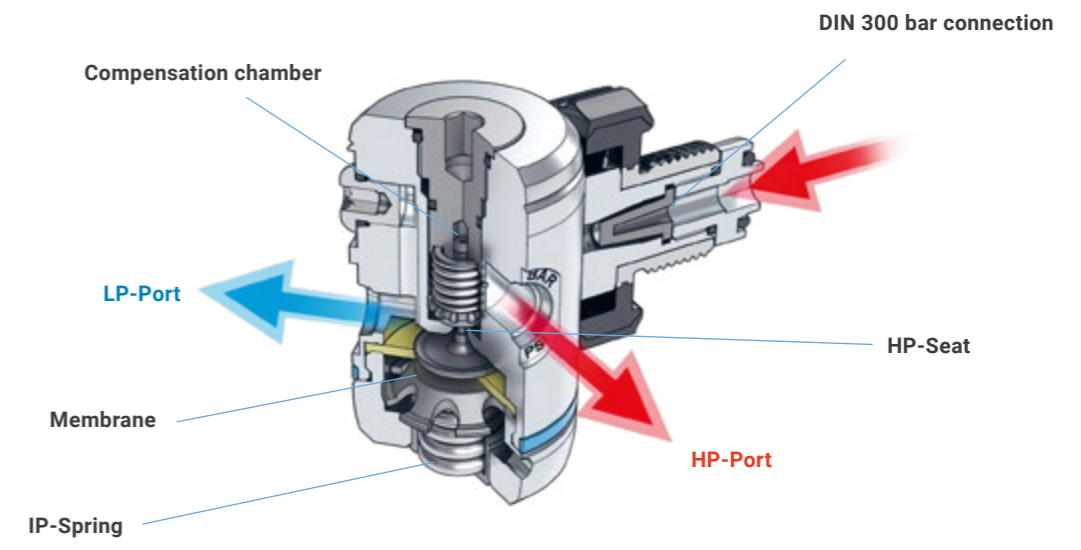

IR-50
THE ADVANCED

INHALATION

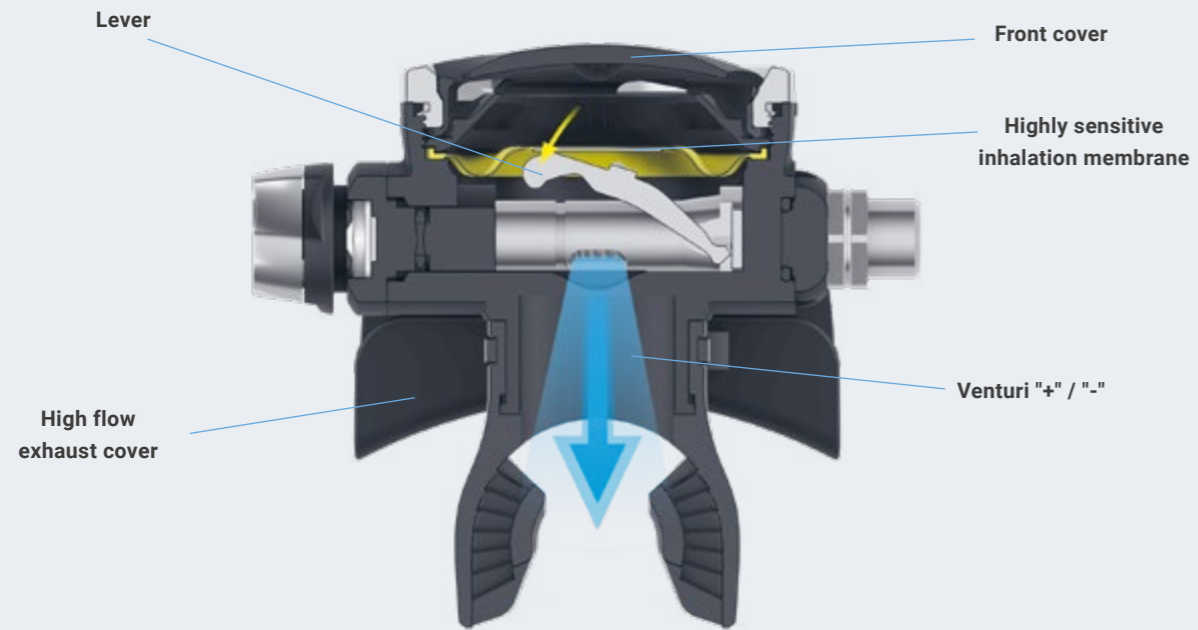

EXHALATION

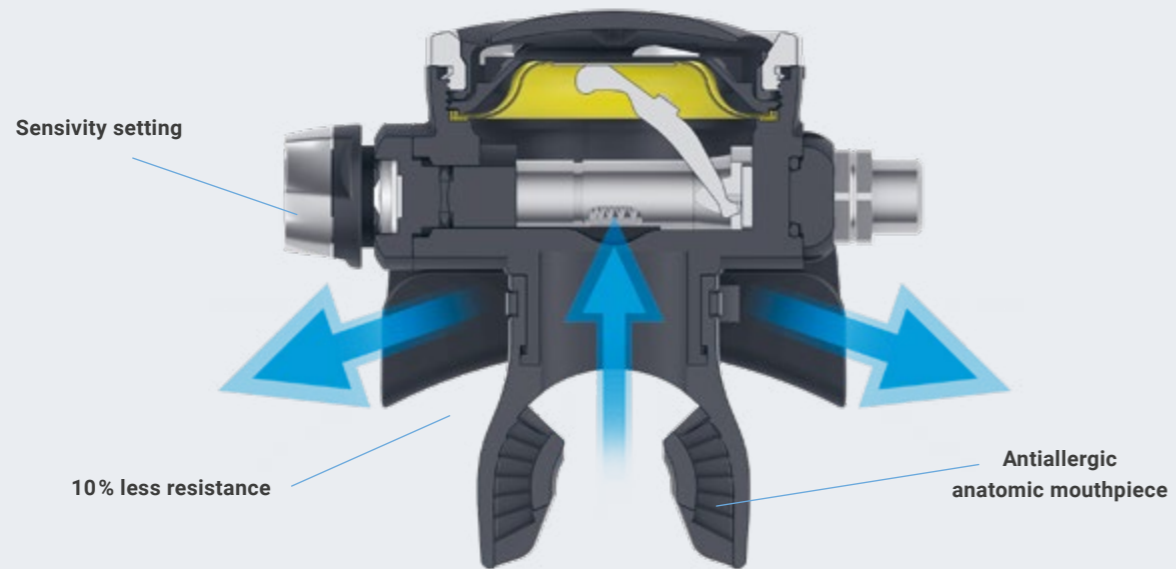

Compensated second stage:

Second stage compensation ensures that regardless of the residual pressure left in the cylinder, your inhalation comfort remains comfortable.

1 Controllable Venturi Effect:

By setting this to "-", the Venturi effect is softened that the second stage does not unintentionally blow off on land. Under water, the Venturi effect is then strengthened on the "+" setting, allowing for easy and comfortable breathing.

2 Response Resistance Adjustment:

Every diver has a personal perception of the "optimal" inhalation resistance. Using the adjustment knob, everyone finds the best personal setting and thus maximum breathing comfort.





CS-30

Regulator 1st + 2nd Stage
DIN / INT

THE WORKHORSE

Connection: DIN 300 bar or INT 232 bar / **Sandblasted brass, matte chrome finish** / Ports: 1 HP 7/16 UNF, 3 LP 3/8UNF / **Non-compensated piston** / Known for its construction characteristics, reliability and robustness / **CE certified according to latest standards** / Adjustable Venturi to prevent free flow on the surface and to reduce inhalation effort during the dive / **Exhaust valve and cover for minimum exhalation effort** / LP hose tested for a maximum pressure of 34 bar / **Mouthpiece made of high-end silicone** / Average breathing work for complete regulator: 0.78 J/L

This is our workhorse regulator for diving centers. Non-compensated piston. Known for its construction characteristics, reliability and robustness in its daily use for diving clubs. Recommended for open and confined waters above 10°C at a maximum depth of 30 m. The second stage is preferred by instructors and diving students for its reliability. In its design the adjustable Venturi (dive/pre-dive) has been prioritized to prevent unnecessary free flow, thus reassuring the student and facilitating breathing during the dive. To ensure comfortable and easy exhalation, the exhaust valve offers minimum resistance, and the exhaust deflector is designed to reduce bubbles on the diver's face. The LP hose is tested for a maximum pressure of 34 bar. The mouthpiece is made of high-end anti-allergic silicone for maximum comfort. The breathing work of the first and second stage CS-30 averages 0.78 J/L.

CE certified according to the latest standards.



CS-31 DIN



CS-32 INT

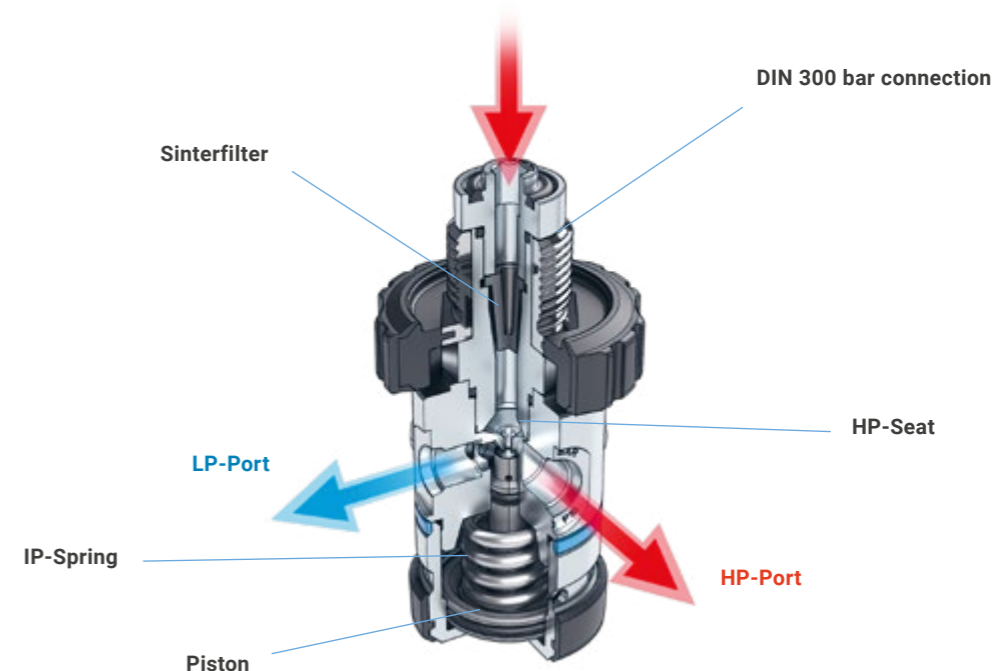

CS-30
THE WORKHORSE

INHALATION

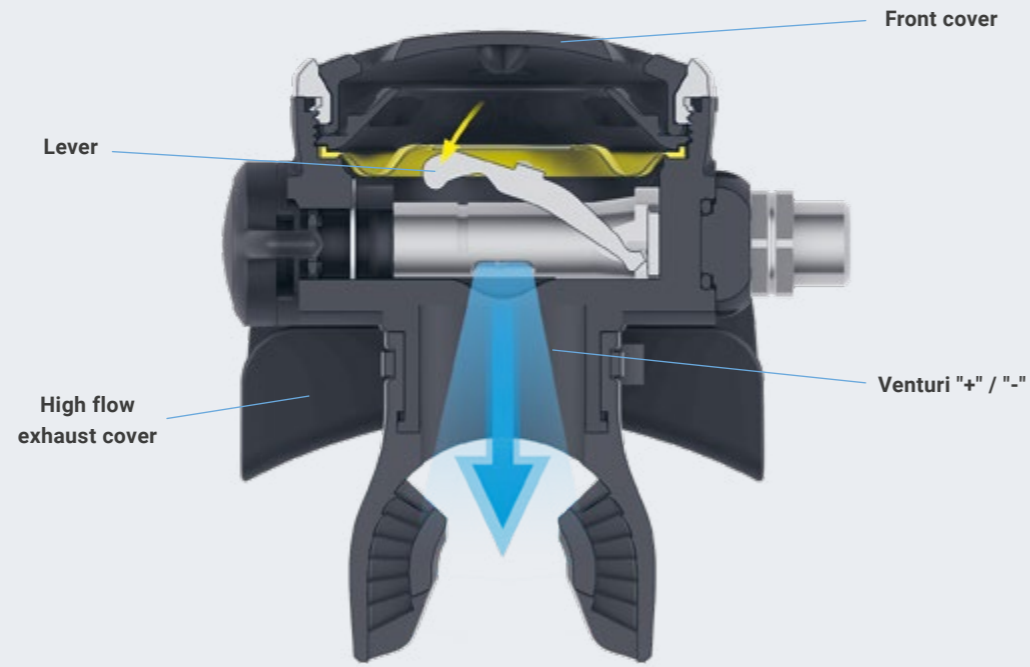

EXHALATION

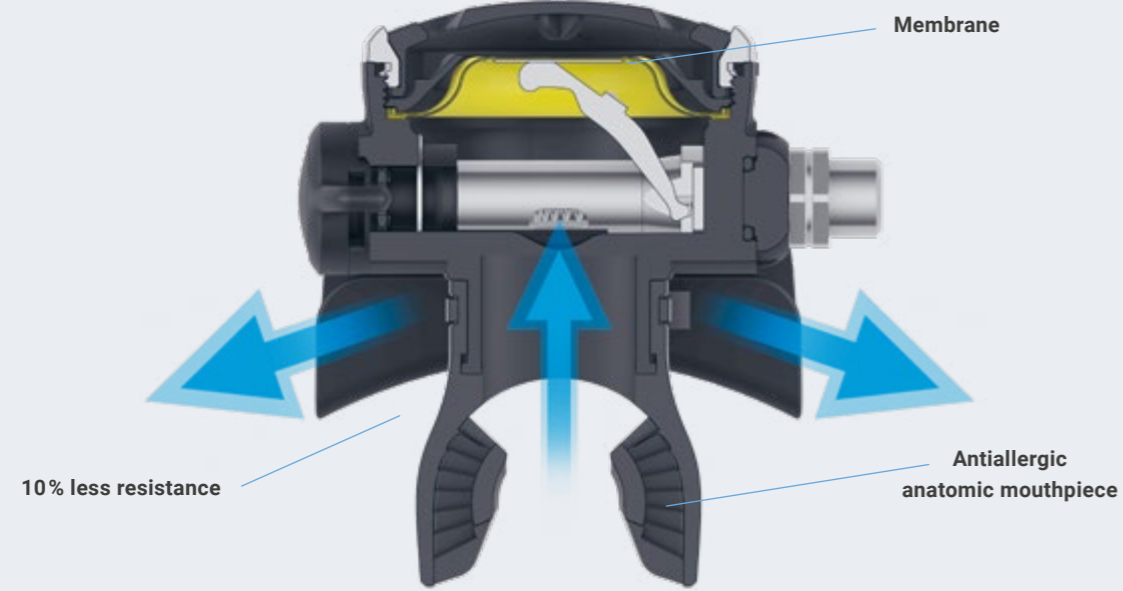

1 Controllable Venturi effect:
By setting to "-" the Venturi effect is weakened so that the second stage does not blow off unintentionally on land. Under water, the Venturi effect is then amplified at the "+" position, allowing for easy and comfortable inhalation.





OP-30

Octopus Regulator 2nd Stage

Adjustable Venturi to prevent freeflow on the surface and to reduce inhalation effort during the dive / **Exhaust valve and deflector provide low exhalation work** / LP hose tested for a maximum pressure of 34 bar / **Mouthpiece made of high-end silicone** / Yellow colour

Instructors and their students love this octopus for its reliability.

The housing includes the adjustable Venturi (Dive/Pre-dive). The exhaust valve and deflector provide very low exhalation work. Our octopus has the same performance and reliability as the main regulator; therefore, our octopus is the same as our second stage CS-30 regulator. In case of emergency it is quickly identifiable by its characteristic yellow colour.

The LP hose is tested for a maximum pressure of 34 bar. The mouthpiece is made of high-grade anti-allergic silicone for maximum comfort.

Equipment Performance

TR-80

Ansti

Certificate Reference
Date: 16/11/2022

DYNAMICNORD

Ansti

Time: 13:43:04

Equipment

Regulator Type **TR-80**
Serial Number 37CC31003
Interstate Pressure Static 9.8 barg

Conditions of Test	Mean	Results (2 Loops, SA: 100)	Mean
Room Temperature (C°)	23.0	Inhale Pressure (mbar)	3.92
Exhale Temperature (C°)	22.9	Inhale Pos Pressure (mbar)	2.58
Water Temperature (C°)	3.4	Exhale Pressure (mbar)	9.76
Humidity (% RH)	9.9	Ext Work of breathing (J/l)	0.86
HP Supply Pressure (barg)	224.4	Inhale Work (J/l)	0.20
Tidal Volume (liter)	2.50	Pos Inhale Work (J/l)	0.01
Breath Rate (bpm)	25.17	Exhale Work (J/l)	0.66
Ventilation Rate (lpm)	62.90		

Pressure - Volume Diagrams at Mean Depth of: 51.7 msw (169.5 fsw)

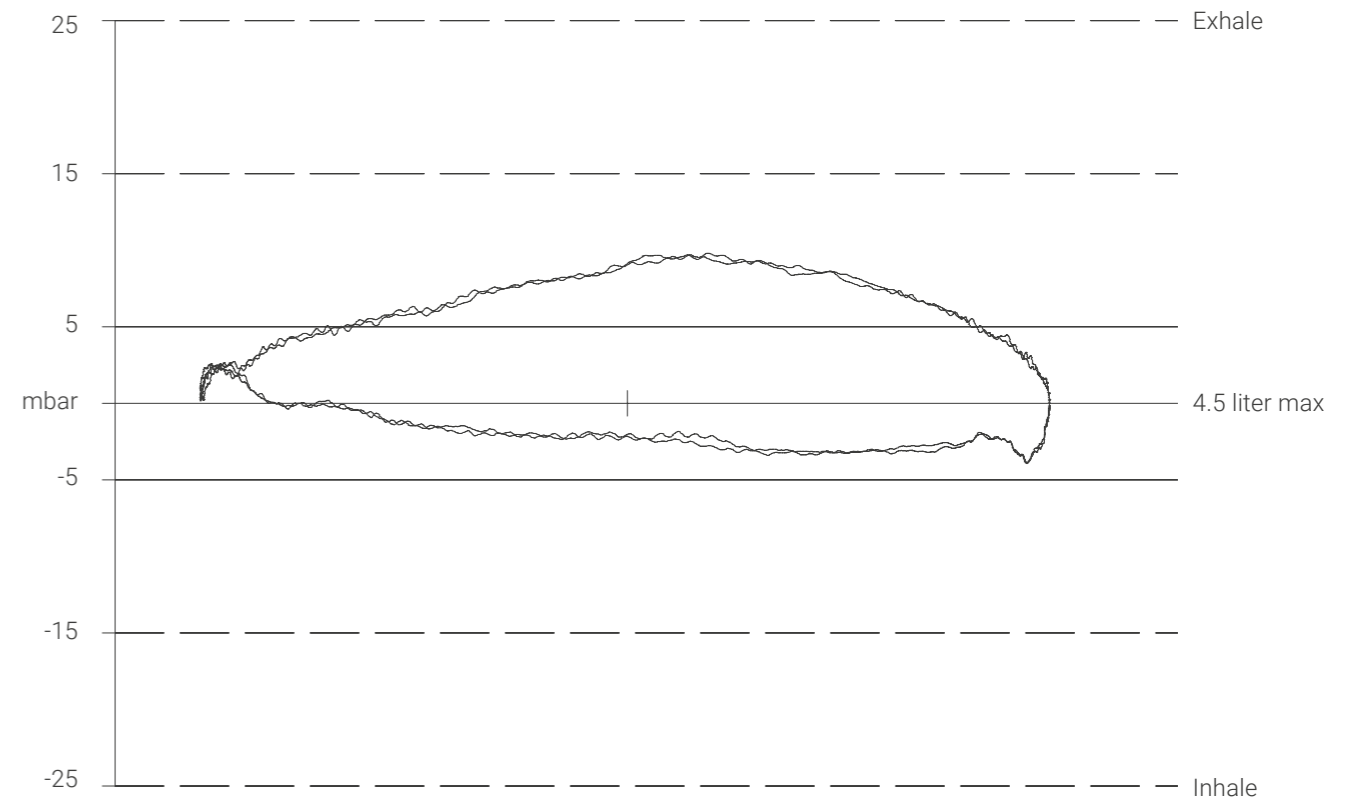

LRB-10

Regulator Bag

EVA body / **Detachable inner flexible strap system for regulators** / Volume adjustment zip / **DN zip puller for main compartment** / Volume: 10,5L / **Dimensions: 40,6 x 25,3 x 10,3 cm**

Perfect for transporting and protecting our regulator, this bag has a flexible and removable inner strap system. Its zip allows you to adjust the volume according to your needs.



Equipment Performance

IR-50

Ansti
Certificate Reference
Date: 16/11/2022

DYNAMICNORD

Ansti
Time: 13:53:05

Equipment

Regulator Type **IR-50**
Serial Number 37CI52002
Interstate Pressure Static 9.8 barg

Conditions of Test	Mean	Results (2 Loops, SA: 100)	Mean
Room Temperature (C°)	23.0	Inhale Pressure (mbar)	4.65
Exhale Temperature (C°)	16.6	Inhalte Pos Pressure (mbar)	3.82
Water Temperature (C°)	3.6	Exhale Pressure (mbar)	10.58
Humidity (% RH)	11.5	Ext Work of breathing (J/l)	0.84
HP Supply Pressure (barg)	215.8	Inhale Work (J/l)	0.11
Tidal Volume (liter)	2.50	Pos Inhale Work (J/l)	0.07
Breath Rate (bpm)	25.11	Exhale Work (J/l)	0.73
Ventilation Rate (lpm)	62.77		

Pressure - Volume Diagrams at Mean Depth of: 51.7 msw (169.5 fsw)

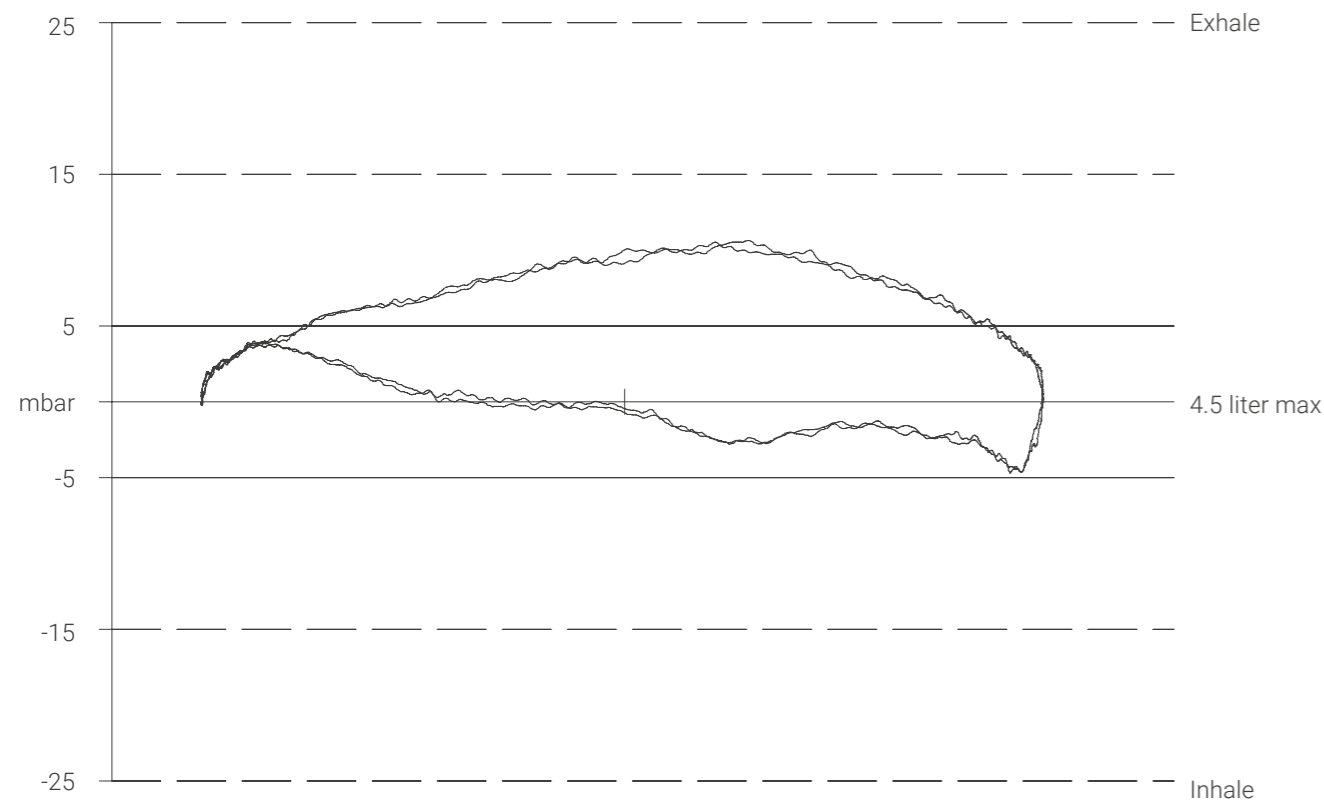

Equipment Performance

CS-30

Ansti
Certificate Reference
Date: 16/11/2022

DYNAMICNORD

Ansti
Time: 14:50:27

Equipment

Regulator Type **CS-30**
Serial Number 37CC32002
Interstate Pressure Static 9.8 barg

Conditions of Test	Mean	Results (2 Loops, SA: 100)	Mean
Room Temperature (C°)	23.0	Inhale Pressure (mbar)	4.95
Exhale Temperature (C°)	15.0	Inhalte Pos Pressure (mbar)	3.55
Water Temperature (C°)	3.2	Exhale Pressure (mbar)	9.47
Humidity (% RH)	8.0	Ext Work of breathing (J/l)	0.78
HP Supply Pressure (barg)	222.6	Inhale Work (J/l)	0.10
Tidal Volume (liter)	2.50	Pos Inhale Work (J/l)	0.09
Breath Rate (bpm)	25.05	Exhale Work (J/l)	0.68
Ventilation Rate (lpm)	62.64		

Pressure - Volume Diagrams at Mean Depth of: 51.9 msw (170.4 fsw)

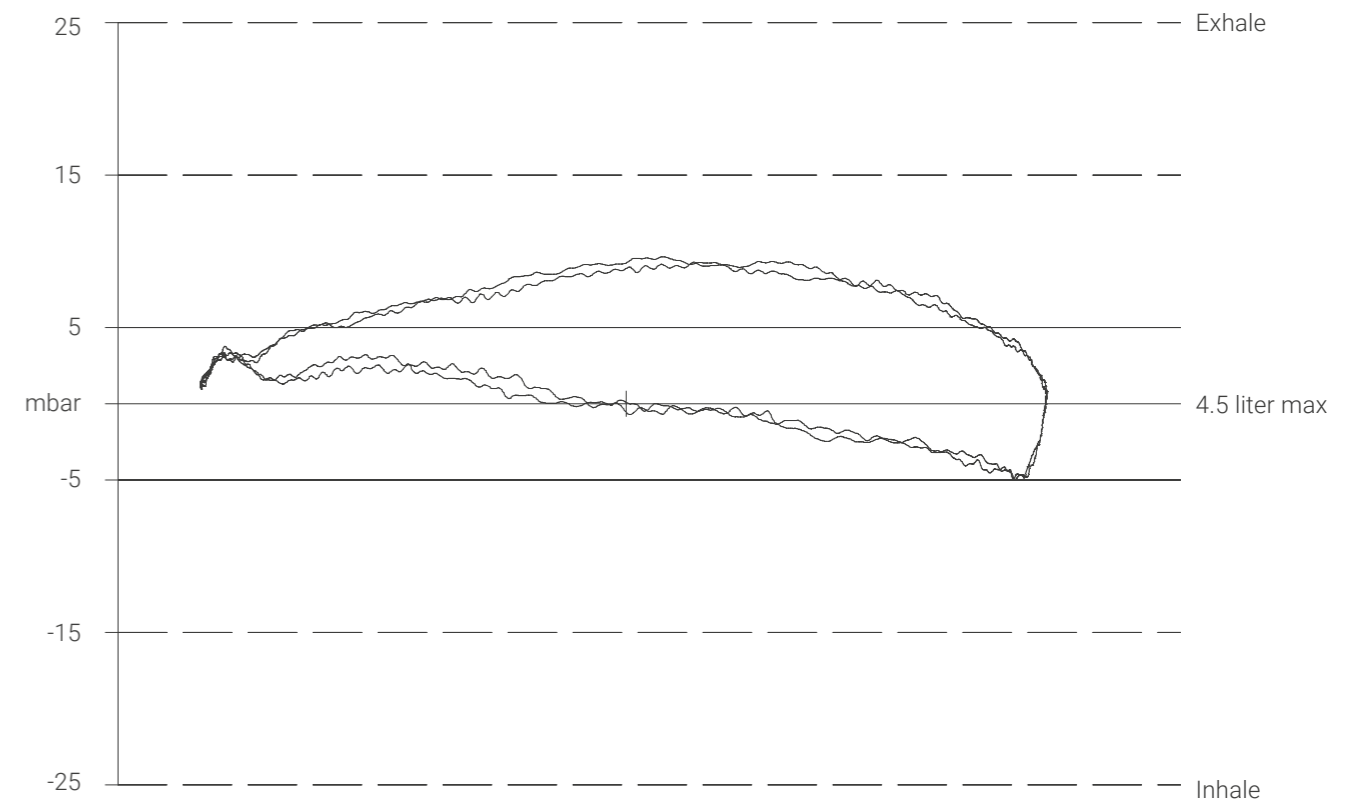



BCDs

Our buoyancy compensating device. We offer different product levels for your preferences, you just choose. Simple and durable. Weight pockets for quick release, trim pockets for better trim. Quality and design for your own level of comfort.

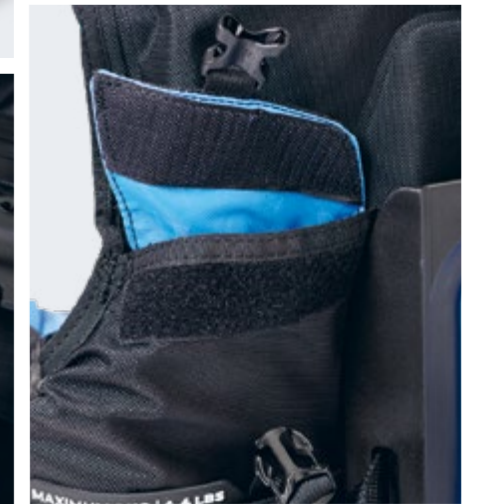

RBC-40

BCD

THE PROGRESSIVE

Suitable for advanced recreational divers / 420 and 840 Denier Nylon combined. 840 Denier nylono for the parts that are most stressed / Backplate padded/ Overpressure (OPV) and Quick Dump (QD) valves perfectly integrated thanks to its slim structure / Two pockets, six D-rings, and a non-slip surface for better tank support / Metal buckle on tank strap / One-handed quick-release weight system in case of emergency

Our RBC-40 model is suitable for advanced recreational divers. It is made of a combination of 420 and 840 Denier Nylon, which gives it a high resistance and durability. We use 840 Denier nylon for the areas that are subject to the most stress. To complement its comfort and functionality, in its design, we have padded the backing plate. Our Overpressure (OPV) and Quick Dump (QD) valves, together with the inflation valve, are perfectly integrated into the RBC-40, thanks to its slim structure. For a comfortable and safe fit, the RBC-40 has a wide abdominal cummerbund, plus two pockets, six D-rings, and a non-slip surface for better tank support. It has a metal buckle on the tank strap. It features newly developed weight pockets for easy insertion, with safe fastening and a one-handed quick-release system in case of emergency.

designed
engineered
in germany



Unisex
black/blue

XS	S	M
L	XL	2XL

SBC-20

BCD

THE CLASSIC



Perfect for diving centers, schools and clubs / **Made with 1000 D Cordura, which gives it high resistance and durability** / Overpressure (OPV) and Quick Dump (QD) valves perfectly integrated thanks to its slim structure / **The high-volume bladder gives it a high lifting capacity** / Two pockets, six D-rings, and a non-slip surface for better tank support



Weight - Depending on size 3,3 kg / 7,2 lbs (XS) – 3,85 kg / 8,5 lbs (2XL)
Lift capacity - Depending on size 90 Newton / 13,5 lbs (XS) – 220 Newton / 33,7 lbs (2XL)

Our SBC-20 model satisfies the needs of diving centers, schools, and clubs, thanks to its main features: safety, comfort and ease of use. It is made with 1000 D Cordura, which gives it a high resistance and durability. Our Overpressure (OPV) and Quick Dump (QD) valves, together with the inflation valve, are perfectly integrated in the SBC-20, thanks to its slim structure. The high-volume bladder gives it a high lifting capacity. For a comfortable and safe fit, the SBC-20 has a wide abdominal cummerbund, in addition to two pockets, six D-rings, and a non-slip surface for better tank support.

designed
engineered
in germany

	Unisex black/red		Unisex black/blue		Unisex black/wintersky
XS	S	M	XS	S	M
L	XL	2XL	L	XL	2XL



D-Rings:

Our own D-rings are made of aluminum and are hard anodized. They have an implied tip and thus fix things that are attached with a carabiner to a position.



Integrated Quick Release:

Pulling on the entire inflator assembly opens a dump valve that allows for quick deflation.

Power Inflator:

Our Power Inflator provides enough air at any depth to intercept a rapid descent and establish hydrostatic balance.

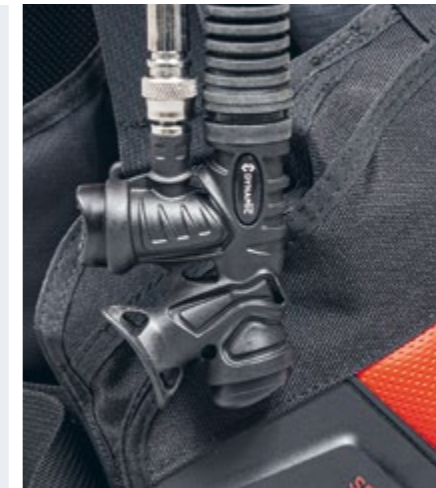
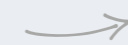

Sizechart BCDs

We recommend choosing your BCD size with your wetsuit on. If the BCD is too tight, it will compress the body and rib cage, making breathing difficult. If it is too wide, it will give you problems, as your tank will „dance“ and affect your buoyancy and control. You must check that the abdominal belt closes perfectly and without difficulty, it is important that the two parts are joined comfortably and fully in its extension.

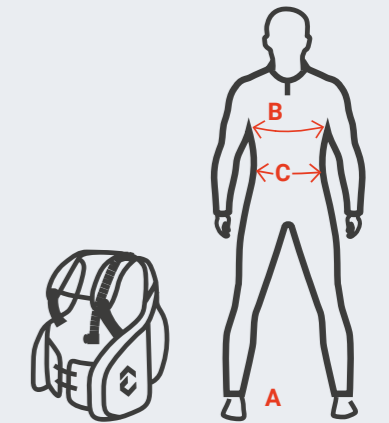

A. WEIGHT: As close as you can accurately determine
B. CHEST: The front surface between the neck and the stomach
C. WAIST: The part below the ribs and above the hips

	Men Women in cm/inch					
Chest	80-90 31-35	90-100 35-39	100-110 39-43	105-115 41-45	115-125 45-49	120-135 47-53
Waist	75-90 30-35	85-95 33-37	95-105 31-33	95-105 35-41	110-120 43-47	115-130 45-51
Weight kg lbs	55-65 121-143	63-78 139-172	75-85 165-187	80-100 176-220	95-120 209-265	110-130 242-287
Size	XS	S	M	L	XL	2XL





INSTRUMENTS

Pressure gauges, compasses, and diving watches. All the instruments you need to complement your diving equipment and make you return safely to the world above the surface.



ST-300

Divers watch 45 mm



316L stainless steel watch, brushed or with black DLC coating / **Rotating bezel with luminescent marker** / Luminous hands and markers / **Scratch-resistant sapphire crystal glass** / Screw-type case back / **Japanese Miyota 2315 (Citizen) Quartz Movement** / Interchangeable silicone rubber band / **Silicone rubber band extension**

Stainless steel, brushed or coated with black Diamond-Like Carbon (DLC) coating, this 316L stainless steel sports watch allows for extreme activities such as diving without physical damage to the watch. The black coating combines the hardness of diamond with the lubricity of graphite. In addition, its crystal is scratch-resistant sapphire. Its bezel is rotating and has a luminescent marker. The screw-down crown is located at 2 o'clock and the date window is at 6 o'clock. Hands and marker are luminous and its interchangeable strap is made of silicone. The screw-down case back covers a Japanese Miyota 2315 (Citizen) quartz movement.

This water-resistant watch can reach a depth of 300 m / 1,000 ft WR.

- black / black
- brushed / orange



designed
engineered
in germany



SPG-1-BM

Pressure Gauge

SPG-1-PF

Pressure Gauge

Dial available in Bar/
Meters and PSI/Feet /
**Operating pressure 300
bar, 400 bar full scale** /
HP hose 80 cm/32"

● black



COM-2-BM

Combo 2 SPG + MDI

COM-2-PF

Combo 2 SPG + MDI

Metric or imperial dials /
Slim design / SPG + MDI
(maximum depth indicator)

● black



COM-1

Compass

Wrist mount /
Oil compensated /
Top or side view

● black



COM-3-BM

Combo 3 SPG + MDI
+ Compass

Metric or imperial dials /
Slim design / SPG +
MDI (maximum depth
indicator) / **Compass
on back side**

● black





MASKS

Single or double lens, high vision angle, low volume, ultra-clear glass, and soft silicone skirt with interchangeable silicone or textile mask strap. Seeing the world under water is our motivation for diving. Quality and comfort for your stay under water.



TG-50

Mask Two Glass

Ultra-clear two-lens mask / **Maximum comfort, low volume, and a wide viewing angle** / Very soft silicone facial seal / **Fast and easy to drain** / Polycarbonate anti-fog glasses / **Easy replacement of the glasses** / QD system. Quick-release buckles on each side / **Black silicone, clear silicone**

Our Ultra-clear two-lens mask has less distance between the lenses and your forehead, improving vision and clarity and making it very easy and fast to drain. In addition, its polycarbonate lenses can be easily modified to correct your eye-sight or can be completely replaced by your optician.

The silicone mask skirt consists of a very soft facial seal and has quick disconnect/release buckles on each side. This allows the classic silicone mask strap to be replaced by an elastic textile strap* that can be easily adjusted to fit your head size. Having a Quick Disconnect system will save you a dive someday...

Our Ultra-clear anti-fog lenses significantly improve underwater vision by allowing up to 94% light transmission. Unlike conventional float glass lenses with a transmission rate of 86% only, Ultra-clear lenses do not show the green tint from standard glass. These polycarbonate next-generation lenses provide incredible clarity and true colours.

* Replacement strap not included.



Our TG-50 mask is supplied in this high quality mask box.





VM-50

Mask Two Glass

Mirrored lens available / **Ultra-low volume** / Purge skirt system / **Down view** / Quick-release buckles / Ultra-clear lens / **Spray-paint colours**

Our ultra-clear mask allows you to see the seabed more clearly. It also provides more downward vision than other masks. It is compatible with corrective lenses and positive bifocal lenses from the optician. The soft silicone patch on either side of the mask's nose pocket makes it easier to pinch the nose for underwater equalization. Its molded frame provides greater comfort when using the mask.

One size

This mask is available in 14 colours:
 black/black - black/grey - black/orange - black/purple - black/red - black/yellow - black/revo mirror
 as well as clear/black - clear/orange - clear/purple - clear/red - clear/yellow



Fade Spray

Clear

CU-40

Mask One Glass

Single-Lens Frameless Mask / **Silicone Skirt and Strap** / Quick-Release Buckles / **One size**



Our single-lens mask offers a wide range of vision. A comfortable mask thanks to its silicone skirt and strap and its quick release buckles.

CU-50

Mask One Glass

Low Volume / **Single-Lens Frameless Mask** / Easy Equalization / **Silicone Skirt and Strap** / Quick-Release Buckles / **One size**



Our single-lens frameless mask offers a comfortable fit and a wide viewing angle. The skirt and strap are made of soft silicone and the buckles are quick release. Frameless masks are appreciated by divers for their low profile and because they are easy to fold and store, for example, in the BCD pocket.

MF-15

Mask One Glass

Low Volume / **Single-Lens Frameless Mask** / Excellent down view / **Two-button Tec Buckle** / **One size**



Our single-lens frameless mask is distinguished by its light weight, low volume, and flexibility. Its design offers an excellent downward view. The skirt and strap are made of soft silicone and the buckles are quick release. Frameless masks are appreciated by divers for their low profile and because they are easy to fold and store, for example, in the BCD pocket.



Available with camera mount



MC-15

Mask Two-Lens

Ultra-low Volume Mini-Mask / **Easy Equalization** / Silicone Skirt / **Two-button Tec Buckle** / One size

This ultra-low volume mask is conceived and designed for free diving and spearfishing. Easy equalization due to its reduced size, and comfortable thanks to its soft silicone. The buckles are easy to remove thanks to its two Tec buttons.

Available in black. Version with mirrored glass effect lens and revo mirror effect.

PA-50

Mask One Glass

Unique lens shape provides expanded field of vision / **Tempered glass lens** / Innovative and patented foldable buckle connector design / **Patented quick-adjusting push buckle system** / Soft black silicone skirt and strap / **One size**



Our panoramic mask provides 30 degrees more field of vision on each side than any other mask. This unique lens shape provides an extended field of vision and great comfort thanks to its tempered glass lens. The skirt and strap are made of soft, black silicone. Innovative design of patented folding and quick-adjusting buckles.



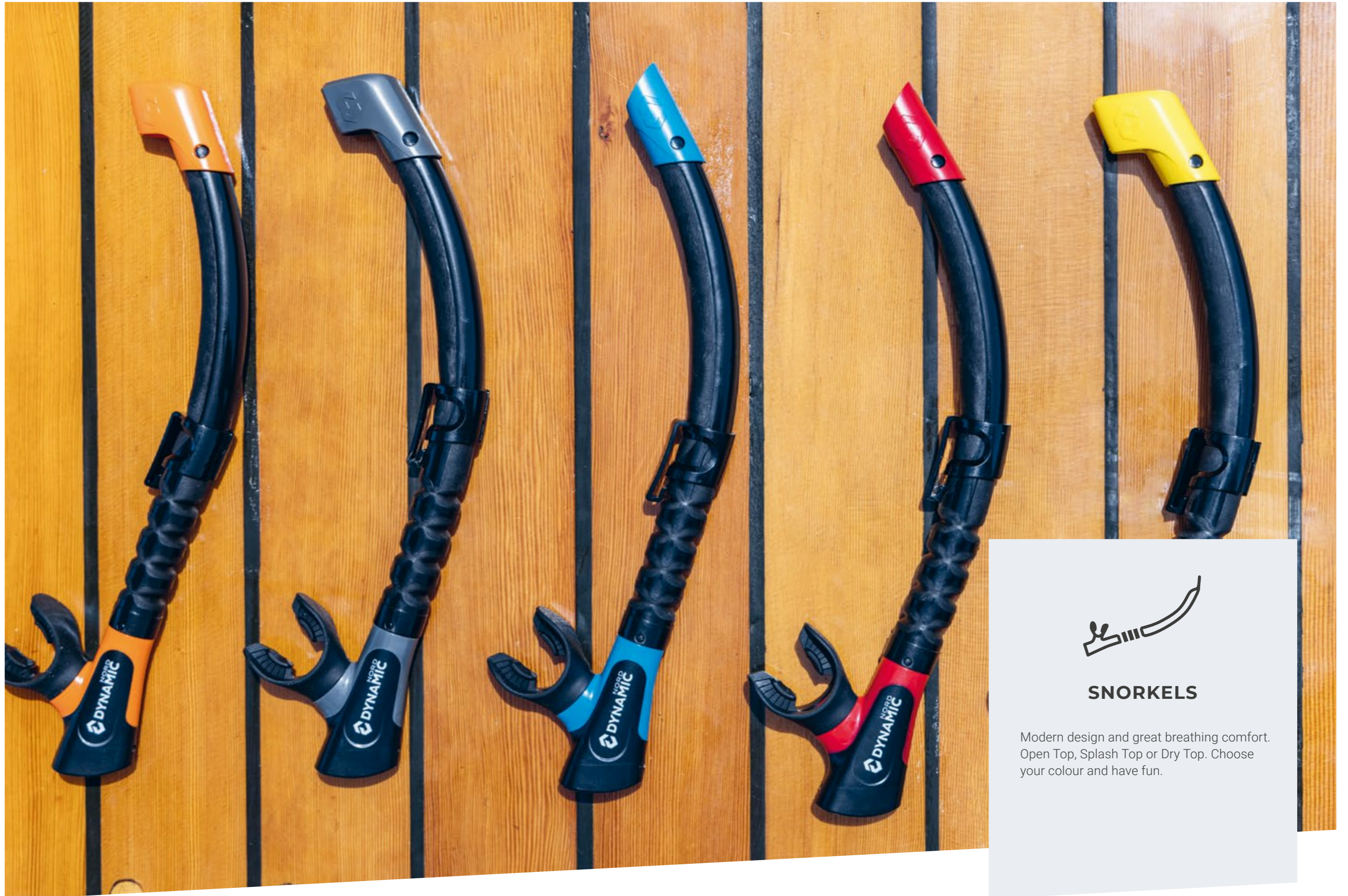

SNORKELS

Modern design and great breathing comfort. Open Top, Splash Top or Dry Top. Choose your colour and have fun.



OT-10

Snorkel Open Top

Drainage of incoming water with less effort / **Flexible and can be bent as needed** / Snorkel support can be adjusted in height and rotation / **Interchangeable mouthpiece made of high-end silicone**

We want you to enjoy your snorkeling trip!

Our Open Top snorkel is the ideal piece for those who seek maximum freedom and performance when snorkeling, and is ideal for divers as a complement to safety on the surface. In its design, an exhalation valve is assembled in the lower part of the snorkel to drain the incoming water. When you exhale, the snorkel valve will open and flush out the remaining water, and you will be ready for your next breath at the surface. The snorkel is flexible and can be bent as needed. The snorkel support can be adjusted in height and rotation, which allows an excellent attachment to the mask. The mouthpiece is made of high-end silicone for maximum comfort and it's interchangeable.



ST-20

Snorkel Splash Top

Our semi-closed top snorkel is the perfect tool for those looking to minimize water entry, with maximum comfort and snorkeling performance. On top of the snorkel tube is a water diverter, preventing most of the water from entering the tube. In its design, an exhalation valve is assembled in the lower part of the snorkel to drain the incoming water. When you exhale, the snorkel valve will open and flush out the remaining water and you will be ready for the next breath at the surface. The snorkel is flexible and can be bent as needed. The snorkel support can be adjusted in height and rotation, which allows an excellent attachment to the mask. The mouthpiece is made of high-end silicone for maximum comfort and it's interchangeable.



DT-30

Snorkel Dry Top

Our closed snorkel tube is the perfect tool for those looking for water entry prevention, whether you are submerged or on the surface in rough seas, maximum comfort, and snorkeling performance. At the top of the snorkel tube is a water diverter, which prevents water from entering the tube. The snorkel is flexible and can be bent as needed. The snorkel holder can be adjusted in height and rotation, which allows for excellent attachment to the mask. The mouthpiece is made of high-quality silicone for maximum comfort and is interchangeable.

designed
engineered
in germany

All snorkels available in 6 colours:
blue / grey / orange / purple / red / yellow

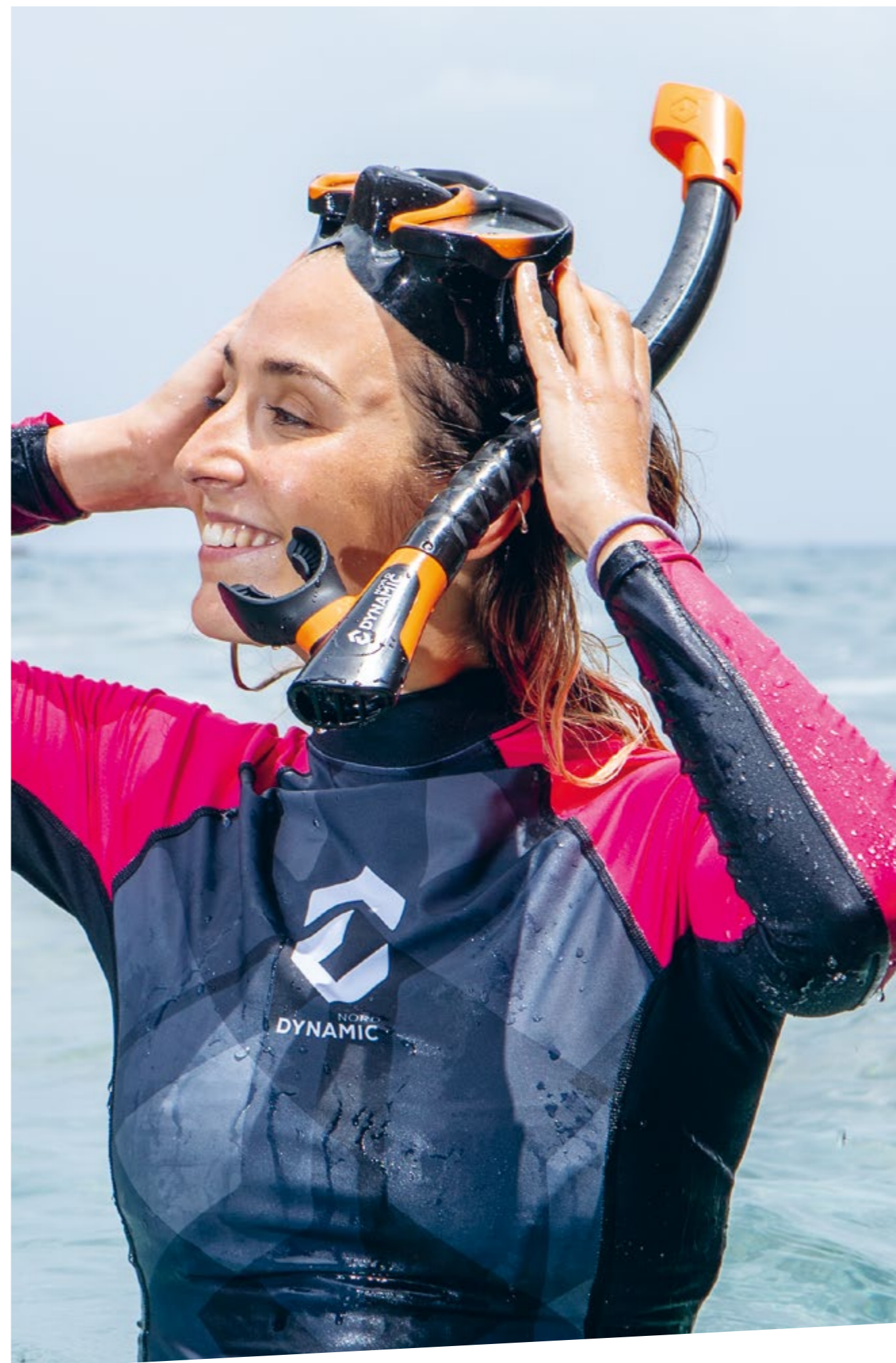

LX-40

Snorkel Splash Top

Semi-dry top snorkel / **Quick-disconnect retainer** / Silicone connector and mouthpiece / **Anti-allergic mouthpiece**

Semi-dry anti-splash snorkel. Designed for maximum comfort, its mouthpiece and connector are made of soft and anti-allergic silicone. Its pre-curved connector adds flexibility to the mid-section of the snorkel, reducing jaw fatigue. Its quick-disconnect system allows for quick release from the mask with a single downward movement.

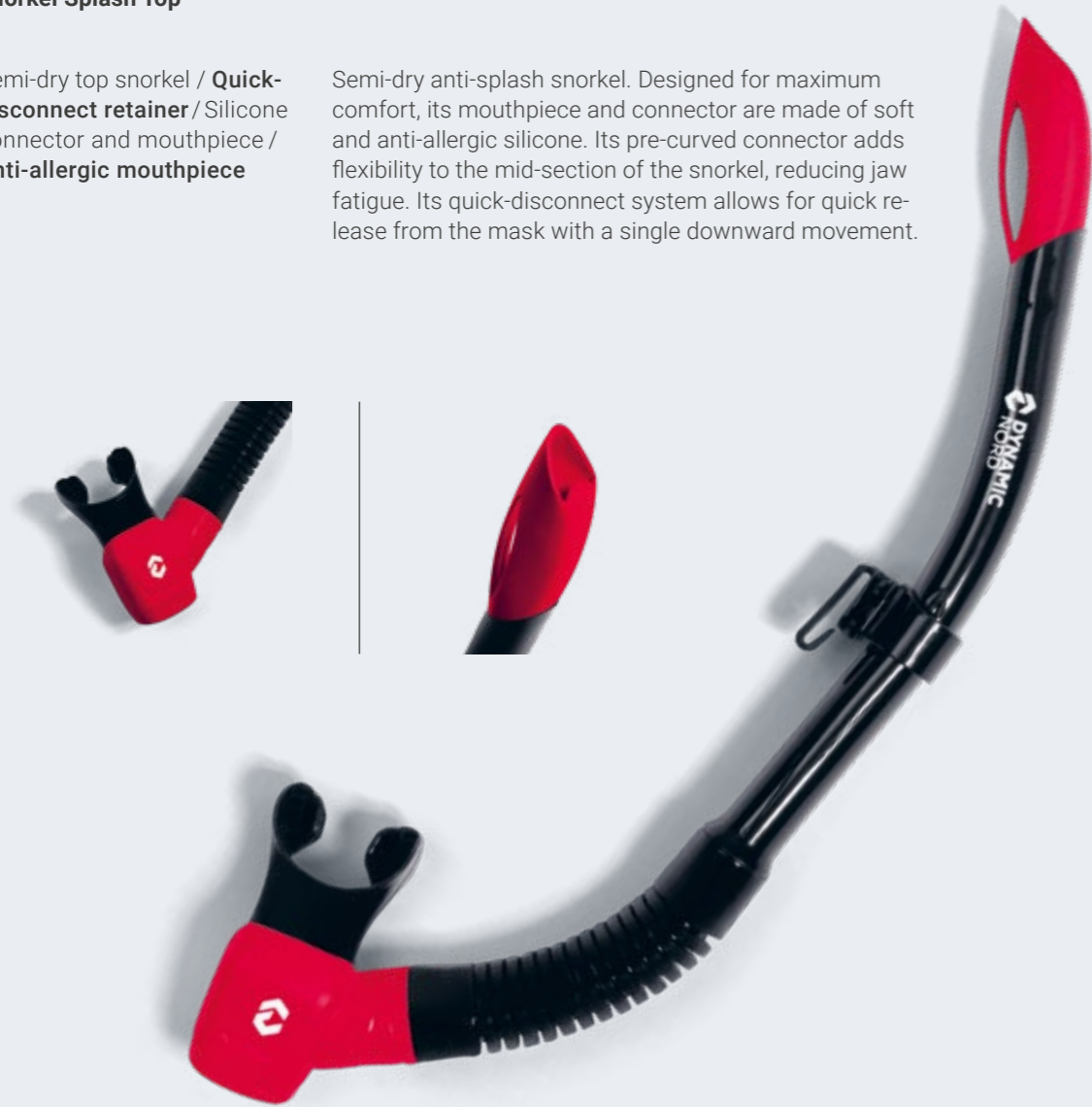

FD-30

Snorkel Dry Top

Submersible dry top snorkel / **Pre-curved connector** / Quick-release snorkel keeper

Designed to prevent water infiltration, whether you are submerged or on the surface in rough seas, this snorkel has a buoy at the top of the tube that lifts and effectively seals the air chamber. Its pre-curved connector adds flexibility to the mid-section of the snorkel, reducing jaw fatigue. Its quick-disconnect system allows for quick release from the mask with a single downward movement.



All snorkels are available in 7 colours: see left page 146

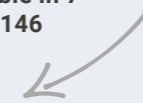

SC-10

Snorkel Open-Top

Low-Profile J-snorkel / **Figure 8 retainer** / Snorkel tube with water transfer colours / **Silicone Mouthpiece**

This snorkel with silicone mouthpiece is conceived and designed for freediving. J-shaped, low-profile snorkel with 8-shaped retainer.



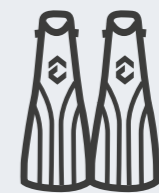

FINS

Open-heel recreational, open-heel technical, or full-foot recreational. Full-foot apnea long-blade fins. Choose your preferred fin. Your kicking style will determine the right fin for you. That fin can then give you the best propulsion under all conditions.

Function Material Design

designed
engineered
in germany

Efficient power transmission and comfortable fit with closed and open shapes, characterize all our newly developed fins. Whether technical diving, recreational diving or snorkeling, the focus is always on kick stability and maneuverability, supported by tested materiality and the design's own lines. The **DYNAMICNORD** colour palette ensures good combinability of our products with each other.



FF-15

RF-40

TF-80

Fullfoot Fins:

Flexible, lightweight snorkel fin with a good fit. All colours of the **DYNAMICNORD** colour palette.

Open Fins:

Powerful blade with strong footplate for optimal power transmission. Allows all different types of fin kicks and delivers perfect propulsion under all flow conditions.

Tech Fins:

Short and powerful open fin for technical divers. Optimal trim due to the use of natural rubber.

Fins **DYNAMICNORD** colour palette.



Bungee Strap with Heelpad:

Attaches to the fin with a quick release buckle. The heel pad has a large finger loop that can be easily grasped even with thick gloves. The bungee strap made of silicone, can be adjusted in length without tools. Thus, our open fins can be easily adapted to classic boots as well as to larger boots in dry suits. No use of metal components - and therefore anti-magnetic.

Small fins
outside: wide



Small fins
inside: short



TF-80

Fins Open Heel



Made for technical divers / **Foot pocket and blade made from rubber with a strong sole inlay** / Bungee strap allows different length adjustments without using any tools

This open fin is made, conceived, and designed for technical divers to perform all the different technical fin kicks. The foot pocket and blade are made from rubber with a strong inlay in the sole to ensure that you have no loss of power transmission from your foot to the blade. This inlay also carries the connection to the buckles for the bungee straps. The bungee strap allows for small length adjustments without using any tools. This allows you to use the same fins with your wet and your drysuit boots.

We recommend this fin to technical and demanding divers.



designed
engineered
in germany

L XL

Length in cm - Depending on size 55 cm (L) – 63 cm (XL)

Weight per pair - Depending on size 2,5 kg (L) – 3,7 kg (XL)



For more details see sizechart on page 160/161

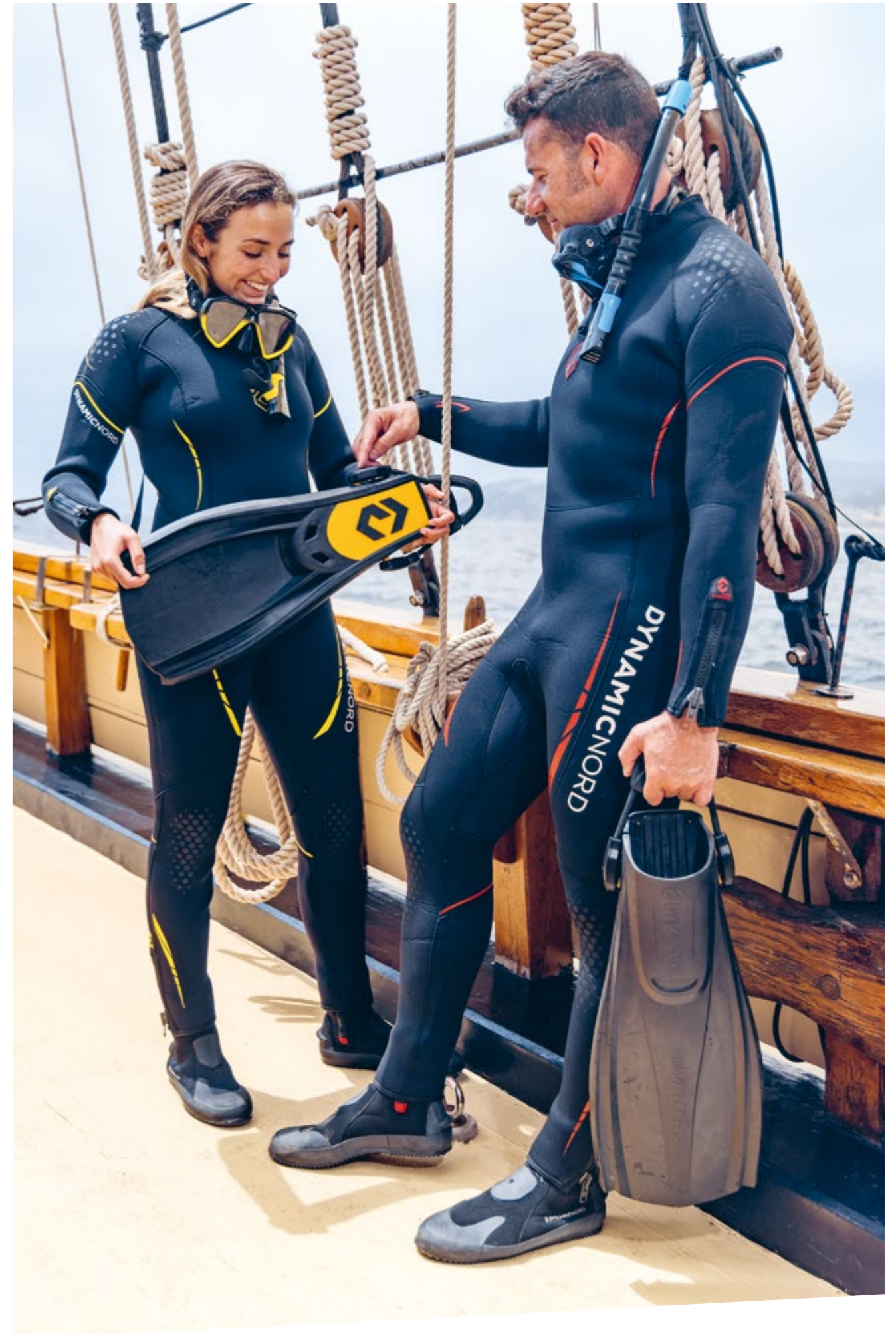

RF-40

Fins Open Heel



Made for recreational divers / **Foot pocket and sole with perfect power transmission to the blade** / Shape and size of blade allows all technical and recreational kicks with the highest propulsion / **Bungee strap allows different length adjustments without using any tools**

We have worked hard on the development of this open fin with the aim of achieving the highest possible effectiveness and comfort. The design of the foot pocket and the sole provide perfect power transmission to the blade. The shape and size of the blade allows technical or recreational fin kicks with higher propulsion and a minimum of fatigue. Bungee strap allows for different length adjustments without using any tools. This enables you to use the same fins with your wet and your drysuit boots.

We recommend this fin as an all-rounder for recreational divers.



designed
engineered
in germany

M L XL

Length in cm - Depending on size 66 cm (M) – 74 cm (XL)

Weight per pair - Depending on size 1,8 kg (M) – 2,6 kg (XL)



For more details see sizechart on page 160/161

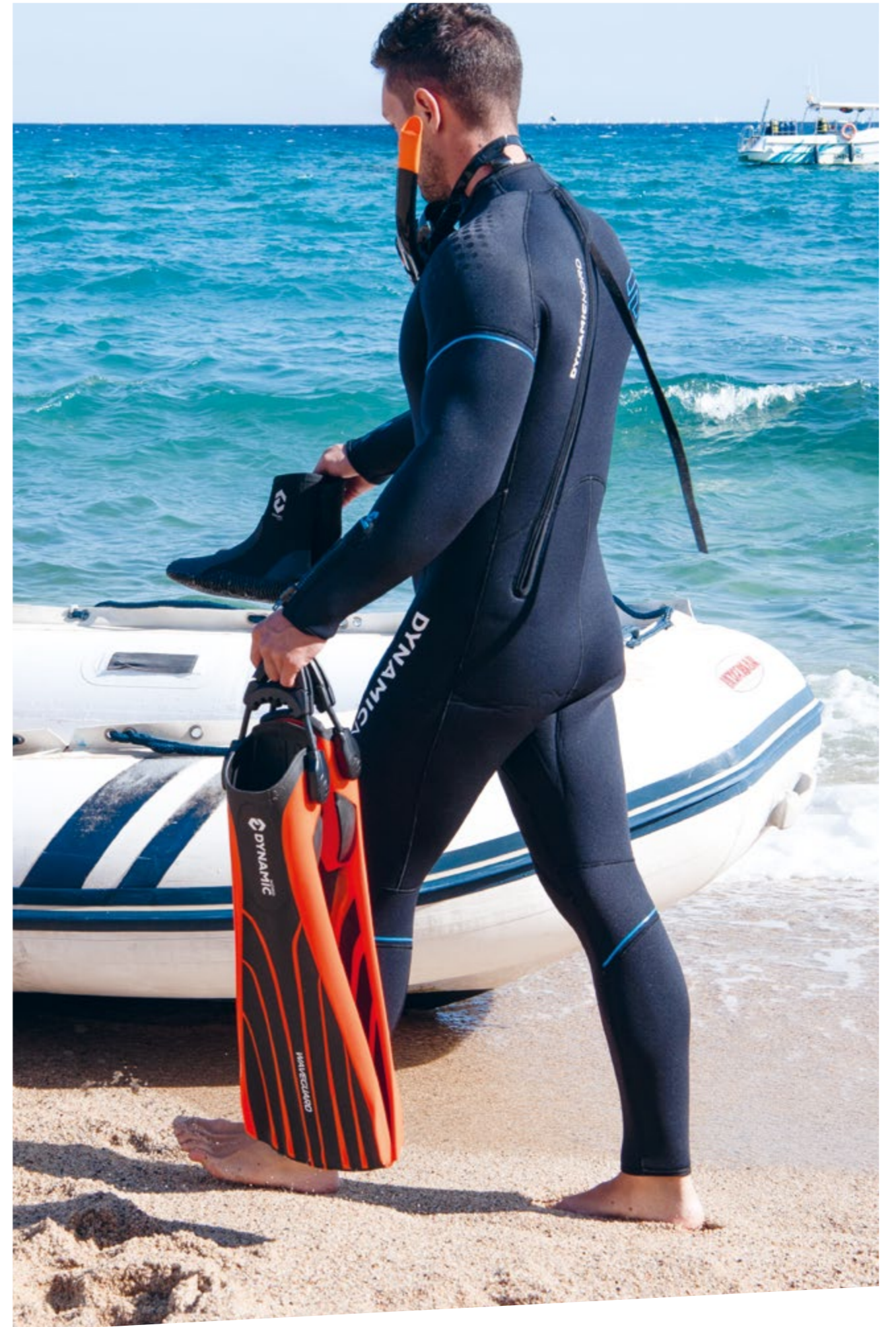



FF-15

Fins Full Foot

High-End Full Foot fin for swimming and snorkeling / **Suitable for warm or temperate waters** / Blade with strong side rails / **Suitable for currents**

We have created this high-end full foot fin to make your dive easy and relaxed. Its design is characterized by a blade with strong side rails that provide a perfect thrust even in strong currents, considerably reducing the sensation of fatigue. Suitable for warm or temperate waters. The full foot fins are used without boots. To avoid heat loss in cold waters we recommend you use our **dynaskin** thermal socks.



designed
engineered
in germany

36/37	38/39	40/41
42/43	44/45	46/47

Length in cm - Depending on size
57 cm (36/37) – 68 cm (46/47)
Weight per pair - Depending on size
1,2 kg (36/37) – 1,7 kg (46/47)



For more details see
sizechart on page 160/161



VF-40

Fins Open Heel



Professional Fin / **Super Channel Blade** / Drag-Reducing fin vent / **Adjustable Quick-Release Buckle System** / TPR Strap

Professional open heel fin with super channel blade. Drag-reducing fin ventilation maximizes thrust and minimizes fatigue while kicking. The soft, arched TPR material built into the blade takes on water during the kick, producing even more thrust.

S M L

Length in cm - Depending on size
60 cm S (40/41) – 68 cm L (44/45)
Weight per pair - Depending on size
1,4 kg S (40/41) – 1,7 kg 2XL (44/45)



158

VF-50

Fins Full Foot



Comfortable and lightweight / **High quality TPR foot pocket** / Drag-reducing fin vent / **Super Channel Technology** / Pre-arched fin design

Comfortable and lightweight, these fins use the highest quality TPR foot pocket to reduce strain on the user's feet. Drag-reducing fin ventilation maximizes thrust and minimizes fatigue while kicking. The soft, arched TPR material built into the blade takes on water during the kick, producing even more thrust.

2 XS XS S M L

Length in cm - Depending on size
60 cm 2XS (36/37) – 67 cm L (44/45)
Weight per pair - Depending on size
1,1 kg 2XS (36/37) – 1,4 kg L (44/45)



For more details see sizechart on page 160/161

Fins Open Heel TF-80

Unisex	in cm/inch	
Foot Length	max. 27 max. 10 2/3	from 28 from 11
Europe Size	44-45	46-47
Size	L	XL

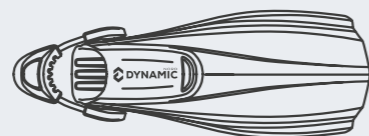

Fins Open Heel RF-40

Unisex	in cm/inch		
Foot Length	max. 25 max. 9 7/8	26-27 10 1/4 - 10 2/3	from 28 from 11
Europe Size	max. 40	41-43	from 44
Size	M	L	XL

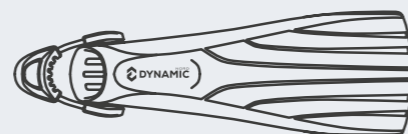

Fins Fullfoot FF-15



Unisex	in cm/inch					
Foot Length	24 9 1/2	25 9 7/8	26 10 1/4	27 10 2/3	28 11	29 11 1/2
Europe Size	36-37	38-39	40-41	42-43	44-45	46-47
Size	XS	S	M	ML	L	XL

Fins Open Heel VF-40

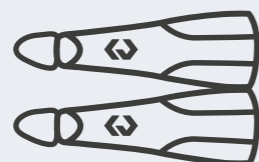

Unisex	in cm/inch		
Foot Length	25 9 7/8	26 10 1/4	27 10 2/3
Europe Size	40-41	42-43	44-45
Size	S	M	L



The best way to choose your size is to try the fin on. Barefoot/thermal socks if it's a fullfoot or with your booties if it's an open heel. You can also measure the length of your foot but keep in mind that every foot is different and is influenced by its width and height of your instep.

Fins Fullfoot VF-50

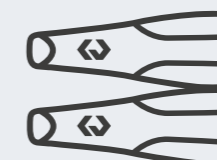

Unisex	in cm/inch				
Foot Length	24 9 1/2	25 9 7/8	26 10 1/4	27 10 2/3	28 11
Europe Size	36-37	38-39	40-41	42-43	44-45
Size	2XS	XS	S	M	L

Fins Freedive AF-70



Unisex	in cm/inch				
Foot Length	24 9 1/2	25 9 7/8	26 10 1/4	27 10 2/3	28 11
Europe Size	36-38	39-40	41-42	43-44	45-46
Size	S	M	L	XL	2XL

Fins Snorkeling-Set FMS-30



Unisex	in cm/inch					
Foot Length	24 9 1/2	25 9 7/8	26 10 1/4	27 10 2/3	28 11	29 11 1/2
Europe Size	36-38	39-40	41-42	43-44	45-46	47-48
Size	XS	S	M	ML	L	XL





SNORKELING SETS

Modern design and great breathing comfort. Open Top, Splash Top or Dry Top. Choose your colour and have fun.



ADULTS

FMS-30

Snorkeling Set

Our snorkel set is composed of a mask, a snorkel, and a pair of fins. The mask and the snorkel are one size, the fins are available in six different sizes.

XS	S	M
ML	L	XL

For more details see sizechart on page 160/161



MS-21

Snorkeling Set

Our snorkel set is composed of a **two glass mask** and a snorkel. The mask and the snorkel are one size.



MS-20

Snorkeling Set

Our snorkel set is composed of a **one glass mask** and a snorkel. The mask and the snorkel are one size.



JUNIORS

MSJ-10

Snorkeling Set Juniors

Our snorkel set is composed of a **one glass mask** and a snorkel. The mask and the snorkel are one size.



MSJ-20

Snorkeling Set Juniors

Our snorkel set is composed of a **two glass mask** and a snorkel. The mask and the snorkel are one size.



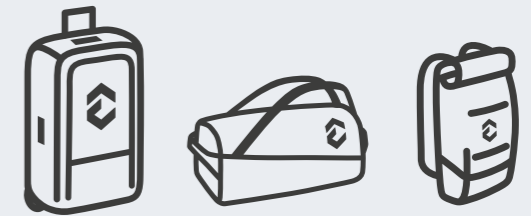

BAGS

Lightweight, functional, durable and of course PVC free bags. Small and large backpacks, Duffel bags, large dive bag.

LDB-75

Duffle Bag

LDB-100

Duffle Bag

Water-resistant / TPU Body / HF welded seams / Water-resistant zipper / Detachable inner dry compartment with taped seams and water-resistant zipper / Flexible backpack carry system with DN D-ring / Fast access zipper outside pocket

LDB-75 Volume: 81 L

Dimensions: 33 x 35 x 67 cm
Water resistance level: IPX 6

LDB-100 Volume: 104 L

Measurements: 33 x 35 x 90 cm
Water resistance level: IPX 6



Medium/Large dive bag with welded seams, water-resistant zip and TPU cover. It contains a watertight and removable inner compartment, with taped seams and water-resistant zip. Easy to carry thanks to its backpack system, it also offers quick access to the outside pocket.



designed
engineered
in germany



LBP-50

Backpack

Water-resistant / TPU
Body / HF welded seams /
Detachable inner dry com-
partment with water-resis-
tant zipper / Inner laptop
compartment with zipped
pocket / Shoulder straps
with DN D-ring hip belt and
moveable chest strap /
Volume control through
different closing possibili-
ties / Extra wide opening /
Outer strap system and
side pockets

Volume: 53,5 L

Measurements: 33 x 20 x 60 cm

Water resistance level: IPX 6



Large backpack with welded seams and TPU cover. Its removable inner dry compartment is taped, the zip is water-resistant. Includes a laptop compartment with an extra zipped pocket. Comfortable backpack thanks to its wide shoulder straps, its hip belt with ring and its mobile chest strap. It offers different closure options, a feature that allows you to easily control the volume according to your needs. It also contains side pockets.

designed
engineered
in germany



LBP-30

Backpack

Water-resistant / TPU
Body / HF welded seams /
Inner laptop compartment
with zipped pocket /
Pocket with bottle holder /
Shoulder straps, hip belt
and moveable chest strap

Volume: 32 L

Dimensions: 31 x 16 x 55 cm

Water resistance level: IPX 6



designed
engineered
in germany

Small backpack with welded seams and TPU cover. Includes a laptop compartment with an extra zipped pocket and a bottle holder. Comfortable backpack thanks to its wide shoulder straps, its hip belt and its moveable chest strap.



LTR-110

Trolley Bag

900 d Gucci Nylon Body / **Detachable inner duffle bag** / Volume adjustment zipper / Two fast access zipper external pockets / **Robust telescopic handle** / Robust 10cm wheels

Volume: 110 L

Measurements:

Body: 44.5 x 39 x 77 cm

Front pocket: 44.5 x 5 x 75 cm

Material: Nylon



Large capacity dive bag, perfect for long trips. Inside it contains a detachable bag that can be used independently. It has two zippered quick access pockets on the outside. Its 10 cm wheels are robust and resistant, as well as its telescopic handle.



Volume adjustment



Removable inner bag

designed
engineered
in germany

LFD-65

Backpack Freediving

Body 900D Gucci Nylon / **Main fin compartment** / Insulated front compartment / **Fixation straps** / Outer pockets for bottles / **Side handle** / Extra feature: Detachable, water-resistant (IPX 6) roll-bag

Volume: 65 L

Measurements: 28 x 28 x 105 cm

Material: Nylon



Freediving backpack with main fin compartment and a separate insulated front compartment. It has outside straps to adjust the volume of the bag and a side handle for carrying. It also has external pockets for bottles. Inside the front, there is a welded and detachable roll-up bag as dry compartment.



designed
engineered
in germany



LNB-95

Netbag

Polyester body / **Fast access zipper pocket outside** / Extra inside zipper pocket

Volume: 98 L
Measurements: 36 x 36 x 77 cm
Material: Nylon

Lightweight bag perfect for storing wet dive gear or if sharing a boat with other divers and don't want to mix gear. Contains a zipped pocket on the outside and an extra zipped pocket on the inside.



designed
engineered
in germany

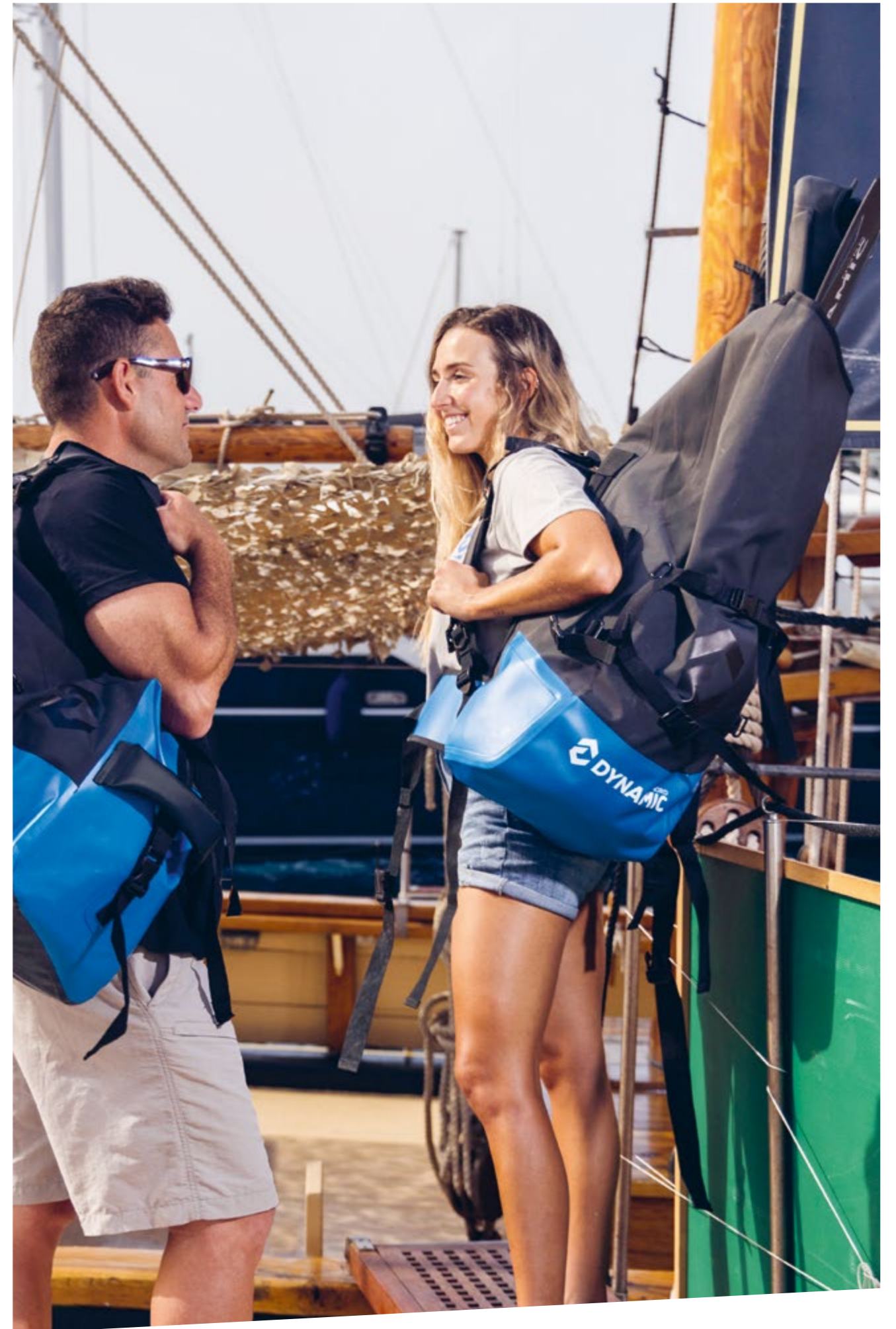

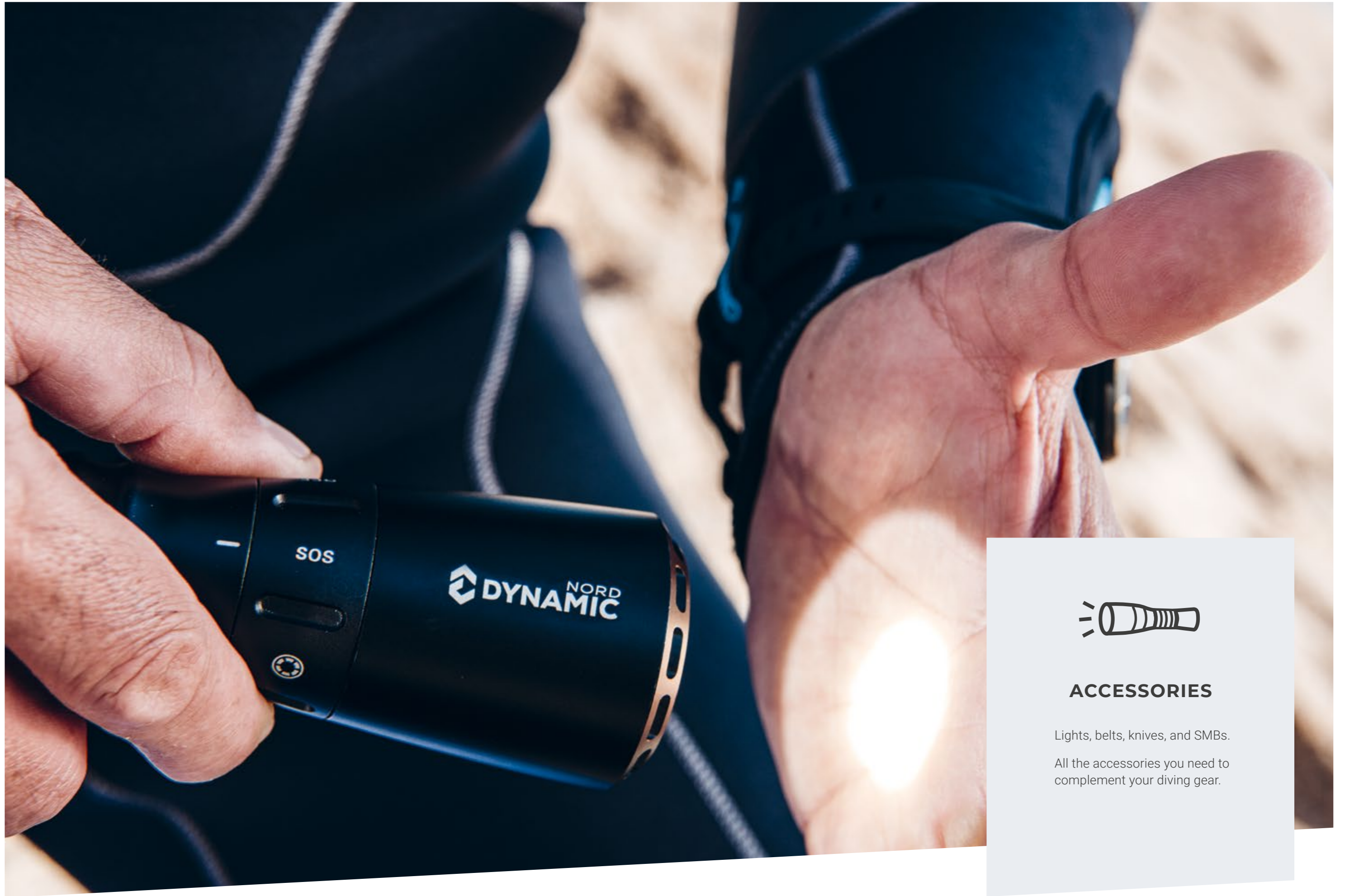

ACCESSORIES

Lights, belts, knives, and SMBs.

All the accessories you need to complement your diving gear.



DL-1200

Dive Light

White LED: 1200 lumens (6500K) / **Output levels: low 300 min, medium 170 min, high 110 min, SOS 230 min** / Light beam angle: 9° / **Battery type: Li-ion battery 18650** / Underwater weight: approx. 159 g (with battery) / **Weight out of water: 233 g without battery, 279 g with battery** / Composition: aluminum / **LRC: LRC 65** / Fastening rope: Lanyard / **Ignition system: magnetic ring switch**



White LED floodlight with a maximum power of 1200 lumens, a light angle of 9° and a colour temperature of 6500K. It has four output levels with a duration of: low 300 min, medium 170 min, high 110 min and SOS 230 min. It is our lightest spotlight made of aluminum; its weight under water is 159 grams (with battery) and 279 grams out of the water (with battery). It has a length of 154.7 mm, a diameter of the head of the light of 41.2 mm and the body of the light of 29 mm. It is waterproof to 100 m deep.

designed
engineered
in germany

DL-2000

Dive Light

Light temperature 2000 lumens (6500K) / **Output low 400 min, medium 250 min, high 200 min, Strobe 500 min, SOS 200 min** / Light beam angle: 15° / **Battery type: 21700 Li-ion Battery with port and USB cable type C** / Charging time: 5-10 hours / **Underwater weight: 215 g with battery** / Weight out of water: 313 g without battery, 385 g with battery / **Composition: aluminum** / Fastening rope: Lanyard / **Ignition system: magnetic ring switch**



Dive light with a maximum power of 2000 lumens, a light angle of 15° and a colour temperature of 6500K. It has five output levels with a duration of: low 400 min, medium 250 min, high 200 min, strobe 500 min and SOS 200 min. Aluminum made; its weight under water is 215 grams (with battery) and 385 grams outside water (with battery). It has a length of 171.7 mm, a light head diameter of 49.5 mm and the light body diameter of 32 mm. It is waterproof up to 100 m deep.

designed
engineered
in germany

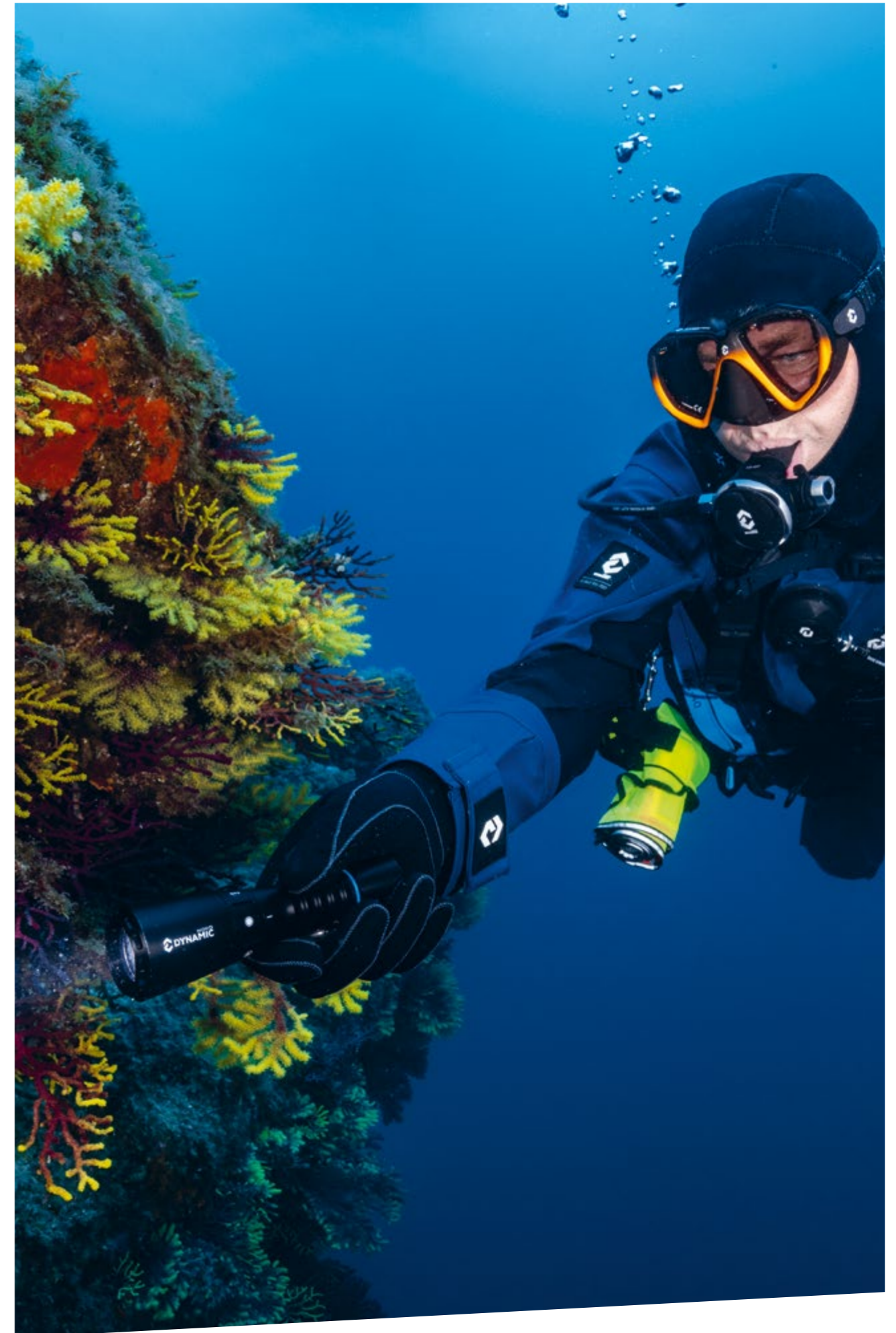

KMI-10

Knife

Stainless steel / **Hardness 55-56 HRC** / Knife straps / **Handle PP or TPE mix** / Blade 5.6 cm / **Weight 52 g**



KES-10

Knife

Stainless steel / **Hardness 55-56 HRC** / Knife straps / **Handle PP or TPE mix** / Blade 11.7 cm / **Weight 270 g**



KEP-10

Knife

Stainless steel / **Hardness 55-56 HRC** / Knife straps / **Handle PP or TPE mix** / Blade 9 cm / **Weight 275 g**



KRA-10

Knife

Stainless steel / **Hardness 55-56 HRC** / Knife straps / **Handle PP or TPE mix** / Blade 8 cm / **Weight 149 g**



KCL-10

Knife

Stainless steel / **Hardness 55-56 HRC** / Knife straps / **Handle PP or TPE mix** / Blade 4.3 cm / **Weight 152 g**



KCU-10

Knife

Stainless steel / **Hardness 55-56 HRC** / Knife straps / **Handle PP or TPE mix** / Blade 11.5 cm / **Weight 200 g**



BN-20

Weight Belt Nylon

Nylon belt / **INOX Belt buckle** / 50 mm width



BR-20

Weight Belt Rubber

Rubber belt / **Classic INOX belt buckle** / 50 mm width



BS-10

Boltsnap

120x33 DIR in SS AISI 316
(naturally corrosion resistant)



BS-20

Bolt Snap 120 mm

Double ender /
120 mm in SS AISI 316
(naturally corrosion resistant)



BS-40

Boltsnap 80 mm

80 mm / Strong in SS AISI
316 (naturally corrosion
resistant)



BS-50

Bolt Snap 100 mm

Double ender /
100 mm in SS AISI 316
(naturally corrosion resistant)



RH-10

Reef Hook

Double steel hook /
Perfect in case of currents



RP-10

Rod Pointer

Ideal for drawing attention
to someone underwater or to
avoid touching corals or sen-
sitive areas with your hands.

Available colours: blue,
orange, green.



FSS-15

Finger Spool Stainless Steel

Stainless steel / 15 m length



FSS-30

Finger Spool Stainless Steel

Stainless steel / 30 m length





SMB-1

Surface Marker Buoy

SMB length 1.8 m / Width 15 cm



SMB-2

Surface Marker Buoy

SMB length 1.8 m /
Width 15 cm / black reel
30m with pouch



SMB-3

Surface Marker Buoy

SMB length 1.5 m / Width 20 cm





FREEDIVING

Enjoy total silence. With our suits, masks and fins specially designed for freediving you will experience magic moments. Take one deep breath and connect with the ocean in the most natural way.



AF-70

Fins Freedive

Apnea Fin for free divers / **Foot pocket and blade made from rubber with a strong sole inlay** / Side rails of the blades allow them to bend over their entire length / **Blade connection designed to ensure maximum strength and durability**



The foot pocket of our Apnea fin provides full power transmission to the blade without any loss of energy. The side rails of the blades allow them to bend over their entire length. The blade connection system ensures maximum strength and durability.



designed
in germany

S	36/38	L	41/42		
M	39/40	XL	43/44	2XL	45/46

Length in cm - Depending on size
85 cm S (36/38) – 89 cm 2XL (45/46)

Weight per pair - Depending on size
1,6 kg S (36/37) – 1,7 kg 2XL (46/47)

For more details see sizechart on page 160/161



AM-30

Apnea Mask

Ultra-low volume mask /
Lens: Tempered glass /
Silicone Skirt and Strap /
Quick-Release Buckles /
Different colours available



Lightweight, ultra-low volume free dive mask. Its lenses are made of tempered glass. A comfortable mask thanks to its silicone skirt and strap and its quick release buckles. Choose your favourite colour and enjoy the sea.



AM-40

Apnea Mask

Ultra-low volume mask /
Lens: Tempered glass /
Reinforced nose / **Silicone Skirt and Strap**



Lightweight, ultra-low volume free dive mask. Its lenses are made of tempered glass. A comfortable mask thanks to its silicone skirt and strap and its quick release buckles. Reinforced nose for better grip.

AM-50

Apnea Mask

Ultra-low volume mask / **Enhanced peripheral vision** /
Impact resistant antifog polycarbonate lens / **Silicone skirt and strap**



Lightweight, ultra-low volume free-dive mask. Its lenses are made of anti-fog polycarbonate and are impact resistant. We have also improved its peripheral vision. A comfortable mask thanks to its silicone skirt and strap.





Available with camera mount



MC-15

Mask Two Glass

Ultra-low Volume Mini-Mask / **Easy Equalization** / Silicone Skirt / **Two-button Tec Buckle** / One size



This ultra-low volume mask is conceived and designed for free diving and spearfishing. Easy equalization due to its reduced size, and comfortable thanks to its soft silicone. The buckles are easy to remove thanks to its two Tec buttons. **Available in black. Version with mirrored glass effect lens and revo mirror effect.**

SC-10

Snorkel Open-Top

Low-Profile J-snorkel / **Figure 8 retainer** / Snorkel tube with water transfer colours / **Silicone Mouthpiece**

This snorkel with silicone mouthpiece is conceived and designed for freediving. J-shaped, low-profile snorkel with 8-shaped retainer.



DY-10

dynaskin Hood



DY-20

dynaskin Socks



100% Windproof / **Water repellent** / Highly breathable / **Neutrally buoyant** / Resilient stretch / **Fast drying** / Odor free / **UV protection** / Easy care

In contrast to neoprene hoods, the Dynaskin hood provides a high level of comfort, thanks to its design and soft inner fabric, avoiding the tackling of the ears and facilitating its placement both on the surface and under water. Thermal socks can be worn directly with full foot fins or inside the boots. Their inner polar fabric will keep your feet warm. Their external composition is highly resistant to accidental rubbing, and anti-humidity technology minimizes odors and facilitates rapid drying.

51% Polyester / 37% Nylon
12% Spandex

designed
engineered
in germany

● Hood

S	M
L	XL

● Socks

S	M
L	XL

For more details see sizechart on page 101



HO-30

Hood 3 mm



designed
in germany



Limestone neoprene

3 mm limestone neoprene hood to prevent heat loss and protect against accidental impacts during the dive.

Neoprene



Unisex
black

S M
L XL

GL-20

Gloves 1.5 mm



designed
in germany



Limestone neoprene

1.5 mm neoprene gloves to protect you from cold, the abrasions and cuts during the dive. Comfortable and very light for use in warm water. Palm, tips and inside of fingers reinforced for better resistance and excellent grip. Closure by means of leatherette flap with Velcro.

Neoprene and Amara



Unisex
black

S M
L XL



SO-20

Socks 2 mm



designed
in germany



Limestone neoprene

2 mm neoprene socks to be worn directly with full foot fins. The rubberized sole is elastic and non-slip, ideal for walking on boat decks and also offers some thermal protection. All seams are glued and stitched for strength and durability.

Neoprene, Nylon,
Rubber Sole



Unisex
black

2XS XS S M
L XL 2XL 3XL

LFD-65

Backpack Freediving

Freediving backpack with main fin compartment and a separate insulated front compartment. It has outside straps to adjust the volume of the bag and a side handle for carrying. It also has external pockets for bottles. Inside the front, there is a welded and detachable roll-up bag as dry compartment.

* More information on page 175



designed
engineered
in germany



SE-31

Fullsuit 3 mm

SE-51-H

Fullsuit Hood 5 mm

SE-32

Fullsuit 3 mm

SE-52-H

Fullsuit Hood 5 mm

Reinforced shoulders and knees / **Resistant against mechanical abrasion**

The back-zipper configuration minimizes the feeling of cold in the wind. For freediving we recommend the fullsuit with hood and front-zipper in 5 mm and the fullsuit with back zipper in 3 mm. The neoprene is abrasion resistant and the fullsuits have reinforcements on shoulder and knees.

80% Neoprene / 20% Nylon



Men
black/blue

XS	S	M	ML
L	XL	2XL	3XL



Women
black/red

XS	S	M	L
XL	2XL	3XL	

designed
in germany

For more details see sizechart on page 58/59





BEACHLIFE

T-shirts, caps, towels and flip-flops.
Everything you need to enjoy a day
at the beach after diving.

BFF-10

Flip-Flops

Flip Flops with Cotton strap in black or sand colour / **Logo on sole** / Rubber patch



designed in germany



BTU-10

T-shirt

Fitted black t-shirt with ribbed neck / **100% combed cotton, 145 g**



designed in germany



BTM-20

T-shirt

Our classic T-shirt in the most modern cut / **Double neck in cotton and elastane** / 100% Cotton, ring-spun, combed and preshrunk, 160 g



designed in germany



BCA-10

Cap

Vintage style and very thick high-quality combed cotton for a more adaptable and soft finish / **Low profile curved visor** / Excellent support thanks to its adjustable back closure with metal buckle / **One size**



designed in germany

BTW-10

Beach Towel

Hammam Towel style / **100% recycled fabric collected from the ocean** / Tested for harmful substances according to Oeko-Tex Standard 100 / **100% sustainable - 2% of the profit goes to One Earth - One Ocean**



designed in germany





AFTER SALES SERVICE

- 206 Warranty
- 206 Product registration
- 207 Service & Repair Center
- 210 Contact



All our products have a two-year limited warranty

In countries that have different legal regulations, **DYNAMICNORD** will apply the national regulations in force. **DYNAMICNORD** warrants to the original purchaser for a period from the date of purchase that the product will be free from defects in materials and workmanship, if it receives normal use, proper care, and prescribed dealer service.

Usually it is limited to a period of 2 years from the date of consumer's purchase of the Product ("Warranty Period") unless otherwise specified. Products or parts with limited lifetime or limited stability may have a reduced warranty time. This will be mentioned in the product description and/or manual. The purchase date must be verified by a valid sales document (tax receipt or sales receipt) and the product registration form.

Warranty coverage does not extend to damage caused by improper use, improper maintenance, neglect, unauthorized repairs, modifications, accidents, fire, casualty, or normal wear. Cosmetic damage, such as scratches, nicks, and fraying are not covered under warranty except when the product is new, out of the original packaging.

Warranty claims are only accepted upon return of the defective product along with the warranty certificate completed in full and signed by the Authorized **DYNAMICNORD** dealer, and accompanied by a valid sales document (tax receipt or sales receipt) showing the date of purchase. **DYNAMICNORD** reserves the right to refuse free service if the required documentation cannot be provided or if information is incomplete, illegible, or incorrect.

DYNAMICNORD rejects the payment of causally incurred consequential damages. Any repaired or replaced product (or part) does not extend the original warranty beyond the period of 2 years from original date of purchase.

DYNAMICNORD will refuse warranty service if the product was not purchased from an authorized **DYNAMICNORD** dealer as listed here, or not registered properly through product registration.

Defects or damages resulting from a failure in material or workmanship are covered by the **DYNAMICNORD** Warranty system.

Exceptions:

- Defects or damages caused by lack of or incorrect maintenance, or through negligence
- Defects or damage caused by heavy, unusual, or incorrect use
- Defects or damages caused by cleaning materials or other substances containing aggressive chemicals
- Defects or damages known or evident at the time of purchase of the product
- Defects or damages caused by improper assembly of the components
- Defects or damages caused by prolonged use of the product in chlorinated or polluted water
- Defects or damages caused by exposing the product to excessive temperatures, fire, or prolonged exposure to sunlight.

If you do not find the information you are looking for, please contact your local dealer or contact us directly through the support service.

PRODUCT REGISTRATION



PRODUCT CARE & MAINTENANCE



Service & repair center

For us, the customer is the most important thing. Our after-sales service department dedicates maximum effort to resolving any incident with the greatest effectiveness and in the shortest possible time.

Located in Germany, our service center has extensive experience and follows very clear guidelines. We strive for quality of service and effectiveness of work to generate the fewest possible remainders and most importantly, to execute the work swiftly.

We are aware that service time is a very important issue for the client, and we work every day to reduce execution times without affecting the quality of our service.

NEOPRENE SERVICE:

DYNAMICNORD Watersport Suits Service
Hauptstraße 16 · 78253 Eigeltingen
Germany

angelika.arbogast@dynamicnord.com
Tel.: +49 (0)7774 / 92 38 666

TECHNICAL SERVICE:

DYNAMICNORD Technical Service Center
Pettenkoferstraße 12 · 83052 Bruckmühl
Germany

support@dynamicnord.com
Tel.: +49 (0)8061 38 98 33-0



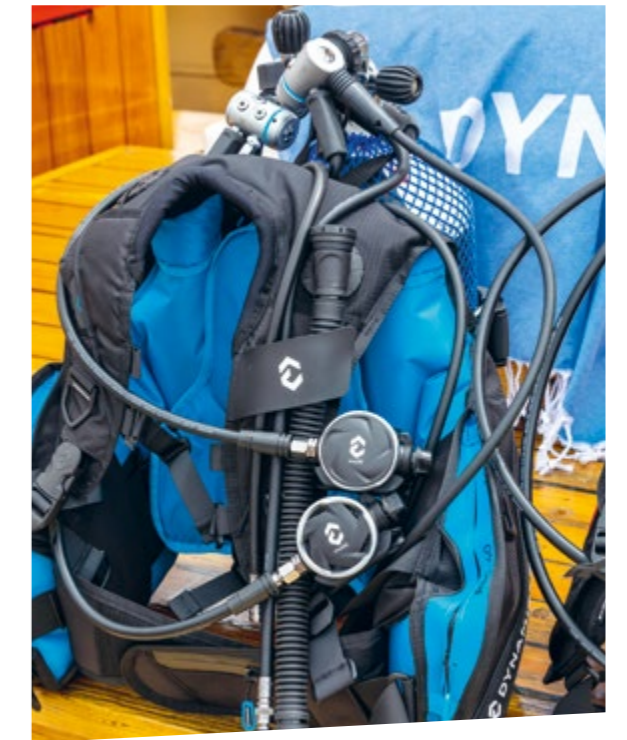
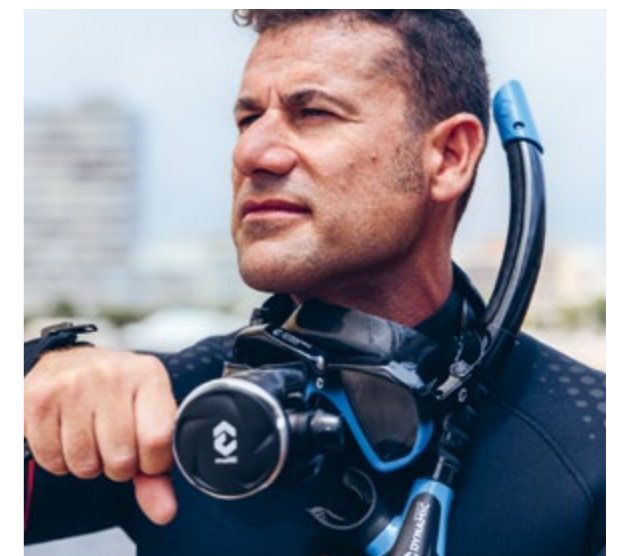
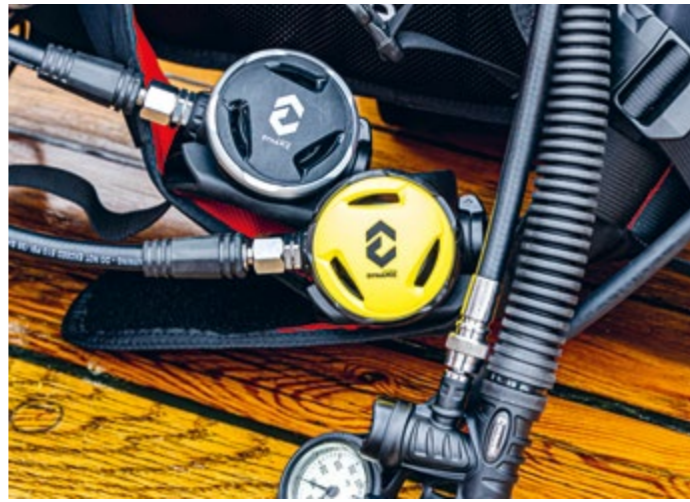



210

Contact

DYNAMICNORD GmbH
Pettenkoperstraße 12
83052 Bruckmühl/Germany
info@dynamicnord.com ©

Showroom Spain

Port Marina - Palamós
c/ Salvador Albert i Pey, 9
Local 7
17230 Palamós / Spain
expo.spain@dynamicnord.com

A big thanks to everybody who helped us creating our brand **DYNAMICNORD** – special thanks to all models and the photo teams:

psmodels / www.ps-models.com

Ana Arce / www.anaarce.com

Ramon Casabayo & Manel Montoro
www.filmmand.net

Jordi Chias / www.uwaterphoto.com

Jan Schmiedel / www.janschmiedel.de

Images: shutterstock.com - New Africa
istock - zoranm
Unsplash - jeremy-bishop

Product and information is subject to change without prior notice.

We don't say goodbye, we say...

see you soon!

designed 
engineered
in germany



We love communities



DYNAMICNORD.COM